

**CONSTRUCTION GUIDELINE**

**DIGITALGRID NCS TRANSMITTER INSTALLATION,  
NETWORK PROTECTORS**

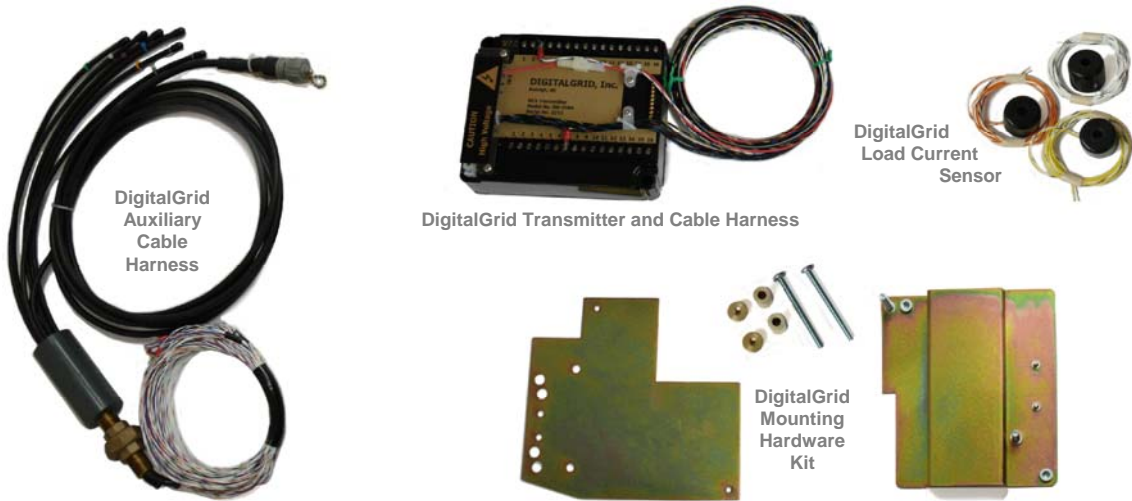

**Scope**

This Guideline covers the remote monitoring system for Network transformers, specifically the DigitalGrid transmitter installation instructions in a Westinghouse, Cutler-Hammer, ETI CM-22, GE MG or MG9 (or equivalent) Network Protector (125/216 and 277/480 Volts – 800 to 3000 Amps).

**Application**

DigitalGrid NCS (Network Communication System) transmitters provide remote monitoring of various transformer data, including anomalies and alarms such as low oil and high temperatures.

DigitalGrid NCS transmitters are to be mounted interior to the Network Protector.

Please note that the NCS transmitter kit contains parts that are internal and external to the Network Protector.

New installations shall be constructed from this Guideline. Refer to NTP-122 for legacy transmitter installations.

NTP-123 and NTP-122 refer to the transmitters used for the remote monitoring system for Network transformers – generally known as the Hazeltine system.

This Guideline is intended to be used by SCL engineers and SCL Network Protector crews.

**Sections**

The balance of this Guideline is divided into four sections:

**Section W** ..... Transmitter Installation Inside Westinghouse NWP ..... pages 2-11

**Section G** ..... Transmitter Installation Inside GE NWP ..... pages 12-18

**Section S** ..... Sensors ..... pages 19-21

**Section R** ..... References ..... page 21

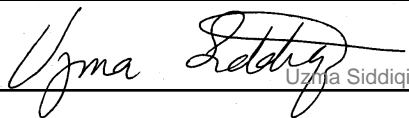
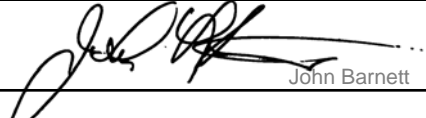
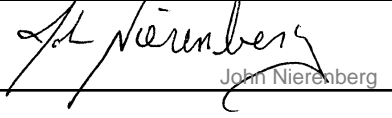
STANDARDS COORDINATOR	STANDARDS SUPERVISOR	UNIT DIRECTOR
 Uzma Siddiqi	 John Barnett	 John Nierenberg

**CONSTRUCTION GUIDELINE**

DigitalGrid NCS Transmitter Installation, Network Protectors

SUPERSEDING: new  
EFFECTIVE DATE: October 3, 2007**Section W: Transmitter Installation Inside Westinghouse, Cutler-Hammer, or ETI CM-22 Network Protectors****W1.0 Introduction**

This installation instruction provides mounting and wiring details for DigitalGrid, Inc.'s NCS Transmitter Kit No. DG-2000 KT-2 when being installed in a Westinghouse, Cutler-Hammer, or ETI CM-22 (or equivalent) Network Protector (NWP). The NCS Transmitter Kit will contain the following:

- W1.1** NCS Transmitter Model No. DG-2000 (See Photo W1)
- W1.2** Three (3) NCS Current Transformers (CTs) Model Nos. DG-400A, DG-400B, and DG-400C (See Photo W2)
- W1.3** NCS Wire Harness Model No. DG-200 (See Photo W3)
- W1.4** NCS Mounting Hardware Accessory Kit Model No. DG-020-2 (See Photo W4) that includes:
  - W1.4.1 Two (2) NCS Transmitter Mounting Thumb Nuts Part No. DG-5004
  - W1.4.2 Two (2) NCS Transmitter Mounting Bolts Part No. DG-5005
  - W1.4.3 Two (2) Adaptor Spacers Part No. DG-5006
  - W1.4.4 Two (2) #8 Bolts Part No. DG-5007
  - W1.4.5 Two (2) #8 Captivated Locks and Nuts Part No. DG-5008
  - W1.4.6 One (1) NCS Transmitter Mounting Bracket Part No. DG-5003

As options to the NCS Transmitter Kit, a NCS NWP Auxiliary Relay Part No. DG-5011 and a NCS Auxiliary Cable Harness Model No. DG-210 (See Photo W7) may also be provided. Wiring instructions for both of these items are provided in this installation instruction.

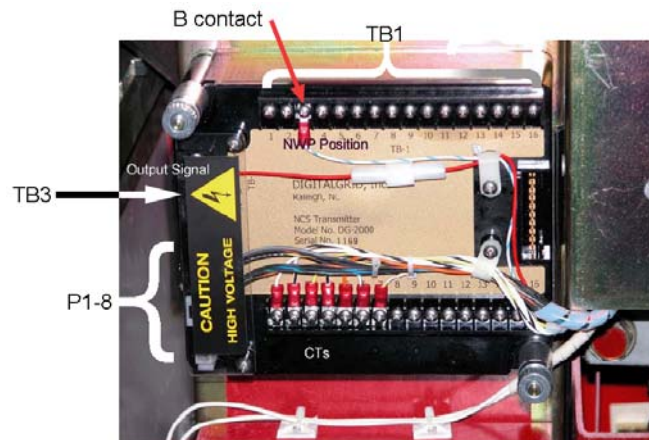

**Photo W1 – Wired NCS Transmitter, Model No. DG-2000**



**Photo W2 – NCS CTs Model Nos. DG-400A, DG-400B, and DG-400C**

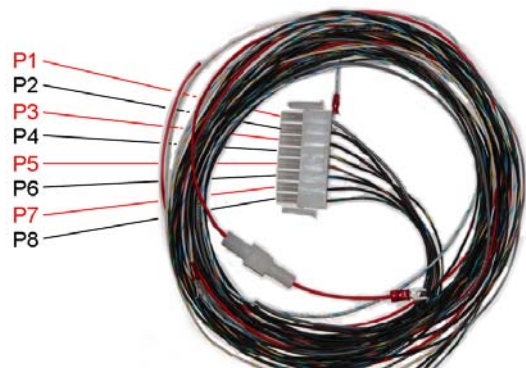

**Photo W3 – NCS Wire Harness Model No. DG-200**

**CONSTRUCTION GUIDELINE**

DigitalGrid NCS Transmitter Installation, Network Protectors

DigitalGrid, Inc.  
Raleigh, NCHardware Accessory Kit  
(excluding Mounting  
Bracket P/N DG-5001/2)  
Model No. DG-020  
Packing List

**Photo W4 – NCS Mounting HW Accessory Kit Model No. DG-020-2 (excluding NCS Transmitter Mounting Bracket)**

**W2.0 NCS Transmitter Model No. DG-2000 Mounting Instruction**

DigitalGrid provides mounting hardware to allow the NCS Transmitter to be installed in a CM-22 NWP. Depending on the configuration of the NWP relays, two different mounting instructions are provided below.

**W2.1 CM-22 NWP with ETI, MPCR, or MPCV Relay**

- W2.1.1 If a CN-J relay dummy plate exists, remove it
- W2.1.2 Complete closing circuit by moving wire #3 at post #4 to wire #46 at post #5 at the CN-J relay socket
- W2.1.3 Install the NCS Transmitter Model No. DG-2000 in place of the CN-J relay dummy plate. Use the two (2) Adapter Spacers Part No. DG-5006 in front of the NCS Transmitter and secure with the two (2) NCS Transmitter Mounting Thumb Nuts Part No. DG-5004 (See Photo 1)
- W2.1.4 Install NCS CTs Model Nos. DG-400A, DG-400B, and DG-400C. Route CT wires to NCS Transmitter per NCS CT Installation Instructions, Section W4.0
- W2.1.5 Route remaining NCS Transmitter wires per NCS Transmitter Wiring Instructions, Section W5.0 and tie-wrap securely

**W2.2 CM-22 NWP with CN-33 and CN-J Relays**

- W2.2.1 Remove dummy plate for the BN relay and both BN relay mounting posts (save both 1/4-20 nuts and locks)
- W2.2.2 Complete trip circuit by removing wire #48 at post #2 and wire #41 or #42 at post #3 and butt connect together. Remove 2 wires #12 if found on post #5 and butt connect together. Completely remove top socket for BN relay socket.
- W2.2.3 Complete current transformer circuits for each phase on lower BN relay socket as follows:
  - W2.2.3.1 Phase A: Move wire #18 on post #7 to wire #13 on post #8
  - W2.2.3.2 Phase B: Move wire #28 on post #9 to wire #23 on post #10
  - W2.2.3.3 Phase C: Move wire #38 on post #11 to wire #33 on post #12
- W2.2.4 Install two (2) NCS Transmitter Mounting Bolts Part No. DG-5005 from back side of NCS Transmitter Bracket Part No. DG-5003. Mount the NCS Transmitter Bracket in place of the BN dummy plate using the two 1/4-20 nuts and locks from the relay mounting posts saved in step 2.2.1 or the two (2) #8 Captivated Locks and Nuts Part No. DG-5008. Photo Nos. 5 and 6 below show the NCS Transmitter Bracket installed in a network protector with and without a NCS Transmitter
- W2.2.5 Install the NCS Transmitter Model No. DG-2000 and secure with the two (2) NCS Transmitter Mounting Thumb Nuts Part No. DG-5004

**CONSTRUCTION GUIDELINE**

- W2.2.6 Install NCS CTs Model Nos. DG-400A, DG-400B, and DG-400C. Route NCS CT wires to NCS Transmitter per NCS CT Installation Instructions, Section W4.0
- W2.2.7 Route remaining NCS Transmitter wires per NCS Transmitter Wiring Instructions, Section 5.0 and tie-wrap securely.

**W3.0 NCS Wire Harness Model No. DG-200 Installation Instructions**

The NCS Wire Harness Model No. DG-200, shown in Photo W3, is supplied with one P1 connector that mates to the J1 connector of the NCS Transmitter Model No. DG-2000. The J1 connector is located in the lower left corner of the NCS Transmitter. The J1 connector is integral to the case of the NCS Transmitter. The NCS Wire Harness is also provided with one red wire for the NCS Transmitter output signal and two wires (white w/blue stripe and white w/yellow stripe) for the NWP position contact. Required wire lugs, tie wraps, and shields to support the installation are included. Wiring Instructions for all wires from the NCS Wire Harness are located in Section W5.0.



*Photo W5 – NCS Transmitter Bracket Part No. DG-5003 in NWP*

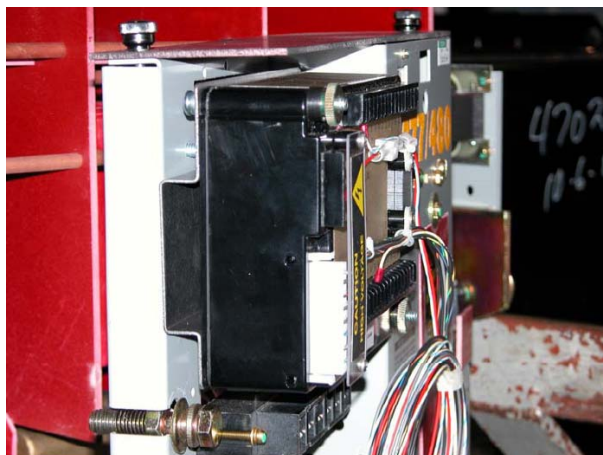

*Photo W6 – NCS Transmitter With NCS Transmitter Bracket Part No. DG-5003 in NWP*

**CONSTRUCTION GUIDELINE**

DigitalGrid NCS Transmitter Installation, Network Protectors

**W4.0 NCS CTs Model Nos. DG-400A, 400B, and 400C Installation Instructions**

The NCS CTs Model Nos. DG-400A, 400B, and 400C, shown in Photo W2, are encapsulated with a small hole in their center. Install the NCS CT Model No. DG-400A on the NWP CT for phase "A", the Model No. DG-400B on the NWP CT for phase "B" and so on by running the lead for the NWP CT through the hole in the center of the NCS CT. Polarity of the NCS CT is identified by the arrow marked on the side of the NCS CT. It is critical that the NCS CT be installed such that the arrow on the side of the NCS CT is pointing in the same direction as the current flow through the NWP CT lead. Wiring instructions for the NCS CT wires are located in Section W5.0.

**W5.0 NCS Transmitter Model No. DG-2000 Wiring Instructions**

Wiring instructions for the NCS Wire Harness Model No. DG-200 and NCS CTs Model Nos. DG-400A, DG-400B, and DG-400C to the NCS Transmitter Model No. DG-2000 are provided in the tables below.

**ALERT!**

**On a 277/480V network protector, the only 277V connection that is made for the transmitter output signal or red wire is terminated at TB-3. Also verify that the network protector is wired 1, 3, 2 to relay.**

**ALERT!**

**On a 277/480V network protector, verify this connection is made on the 120V side of PT.**

**Table W5.0**

NCS Transmitter Connector or Terminal Board Connection Location	Wire Color	Purpose	Wire Number (NWP Wire to Relay)	NWP Connection Location
P1-1	grey	ground	na	solid ground at master relay top socket post #5
P1-2	black	120VAC power for NCS transmitter	31	"B" phase on network side of NWP at rear test knob 21(B).
P1-3	black with red stripe	"A" phase network side voltage	11	"A" phase on network side of NWP at rear test knob 11(B).
P1-4	black with yellow stripe	"B" phase network side voltage	31	"B" phase on network side of NWP at rear test knob 21(B).
P1-5	black with orange stripe	"C" phase network side voltage	21	"C" phase on network side of NWP at rear test knob 31(B).
P1-6	black with blue stripe	"A" phase transformer side voltage	12	"A" phase on transformer side of NWP at rear test knob 12(B).
P1-7	black with violet stripe	"B" phase transformer side voltage	32	"B" phase on transformer side of NWP at rear test knob 22(B).
P1-8	black with green stripe	"C" phase transformer side voltage	22	"C" phase on transformer side of NWP at rear test knob 32(B).



**CONSTRUCTION GUIDELINE**

DigitalGrid NCS Transmitter Installation, Network Protectors

NCS Transmitter Connector or Terminal Board Connection Location	Wire Color	Purpose	Wire Number (NWP Wire to Relay)	NWP Connection Location
TB-3-R (see Note W5.0)	red	transmitter output signal if 45KHz is selected	na	directly to "B" phase of the transformer side of the NWP
TB-3-B (see Note W5.0)	red	transmitter output signal if 50KHz is selected	na	directly to "B" phase of the transformer side of the NWP
TB-3-G (see Note W5.0)	red	transmitter output signal if 55KHz is selected	na	directly to "B" phase of the transformer side of the NWP
TB-3-Y (see Note W5.0)	red	transmitter output signal if 62KHz is selected	na	directly to "B" phase of the transformer side of the NWP

*Note W5.0:* The transmitter will be pre-wired with the red transmitter output signal wire on TB-3-G. If an output signal frequency other than 55KHz is used, open up the white disconnect installed on the red transmitter output signal wire (refer to Photo W1 which shows the white disconnect) prior to moving the signal wire from TB-3-G to the appropriate terminal board connection (TB-3-R, TB-3-B, or TB-3-Y). Once the wire is re-terminated, re-close the white disconnect.

**W5.1 NCS CTs**

The following wiring instructions are for the NCS CTs. Install the NCS CTs at "X1" of the NWP current transformer with wire # identified in table below running through it. The arrow on the NCS CT must point towards the NWP current transformer.

Once the NCS CTs are installed, tape the two wires for each NCS CT together before running wires to the NCS Transmitter to verify proper connections are made at the NCS Transmitter.

*Note W5.1:* When installing digital ground CT on CM-22 style NP (Richards and Cutler Hammer), place CT such that current arrow on CT is physically pointing toward the X1. See Diagram W5.

**Table W5.1**

NCS Transmitter Connector or Terminal Board Connection Location	Wire Color	Purpose	NWP Connection Location
TB-2-1	white	"A" phase current (CT X1)	from NCS CT Model No. DG-400A for phase "A" on wire #13
TB-2-2	white with black stripe	"A" phase current return (CT X1 RTN)	from NCS CT Model No. DG-400A for phase "A" on wire #13
TB-2-3	yellow	"B" phase current (CT X2)	from NCS CT Model No. DG-400B for phase "B" on wire #23
TB-2-4	white with black stripe	"B" phase current return (CT X2 RTN)	from NCS CT Model No. DG-400B for phase "B" on wire #23
TB-2-5	orange	"C" phase current or (CT X3)	from NCS CT Model No. DG-400C for phase "C" on wire #33
TB-2-6	white with black stripe	"C" phase current return (CT X3 RTN)	from NCS CT Model No. DG-400C for phase "C" on wire #33

**CONSTRUCTION GUIDELINE**

DigitalGrid NCS Transmitter Installation, Network Protectors

SUPERSEDING: new  
EFFECTIVE DATE: October 3, 2007

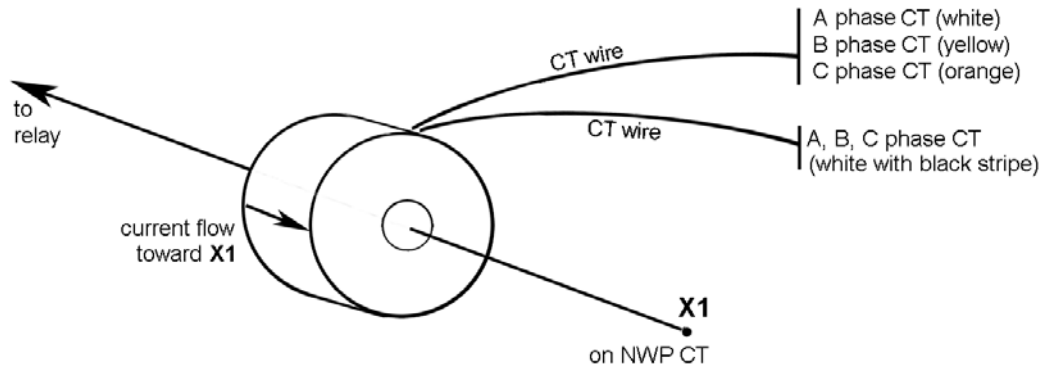

**Diagram W5 – NCS CT orientation (3 CT representation)**

**W6.0 NCS NWP Auxiliary Relay Part No. DG-5011 Mounting and Wiring (currently not in use)**

A NCS NWP Auxiliary Relay Part No. DG-5011 can be provided if a NWP position contact is not available. The NCS NWP Auxiliary Relay is provided pre-wired. If a NCS NWP Auxiliary Relay has been provided it should be mounted and wired as follows.

W6.1 Mount NCS NWP Auxiliary Relay to back of NCS Transmitter Bracket Part No. DG-5003 and secure with #6 nut and lock washer (provided with NCS NWP Auxiliary Relay).

Wire NCS NWP Auxiliary Relay per table below.

**Table W6.0 (currently not in use)**

<b>NCS NWP Auxiliary Relay Wire Color</b>	<b>Purpose</b>	<b>NWP or NCS Transmitter Connection Location</b>
black	ground	to solid ground
red	120VAC for relay coil when NWP position is closed	location within NWP to be determined by customer
white with blue stripe	one side of NCS NWP auxiliary relay position contact	TB-1-3 on NCS transmitter
white with yellow stripe	other side of NCS NWP auxiliary relay position contact	TB-2-7 on NCS transmitter

**W7.0 NCS Auxiliary Cable Harness Model No. DG-210 Wiring Instructions and Additional Terminal Block Wiring Details**

A NCS Auxiliary Cable Harness Model No. DG-210, shown in Photo W7, is provided to allow connection between the NCS Transmitter Model No. DG-2000 and sensors located external to the NWP. The NCS Auxiliary Cable Harness also allows programming of the NCS Transmitter without opening the NWP.

**NOTE W7.0: Verify multitap CTs are wired according to NTP-80.**

**CONSTRUCTION GUIDELINE**

DigitalGrid NCS Transmitter Installation, Network Protectors

**Table W7.0**

<b>Terminal Block (TB2)</b>	<b>Connection</b>	<b>Wire Color</b>	<b>Purpose</b>	<b>Auxiliary Cable External to NWP</b>
TB2-7	jumper to TB1-2 (to one side of the auxiliary NWP position contact (B contact) that is closed when NWP is open)	white with yellow stripe	A/B RTN (NWP position contact)	na
TB2-8	auxiliary cable wire (Model DG-210) internal wiring	white with grey stripe/ white with brown stripe	C/D RTN	black on grey/black on white tagged auxiliary cable
TB2-9	auxiliary cable wire (Model DG-210) internal wiring	white with green and brown stripes/ white with violet stripe	E/F RTN	white on orange/white on violet tagged auxiliary cable
TB2-10	Auxiliary Cable wire (Model DG-210) Internal Wiring	na	G/H RTN	na
TB2-11	Auxiliary Cable wire (Model DG-210) Internal Wiring	white with brown and black stripes	+ 5VDC COM 2 RTN	J1-1
TB2-12	Auxiliary Cable wire (Model DG-210) Internal Wiring	white with red stripe	+ 5 VDC COM 2	J1-2
TB2-13	Auxiliary Cable wire (Model DG-210) Internal Wiring	white with grey and brown stripes	RX +	J1-3
TB2-14	Auxiliary Cable wire (Model DG-210) Internal Wiring	white with purple and black stripes	RX -	J1-4
TB2-15	Auxiliary Cable wire (Model DG-210) Internal Wiring	white with purple and brown stripes	TX +	J1-5
TB2-16	Auxiliary Cable wire (Model DG-210) Internal Wiring	white with black and blue stripes	TX -	J1-6

**W7.1 NCS Auxiliary Cable Harness Model No. DG-210 Wiring Instructions and Additional A16 Terminal Block Wiring Details**

*Note W7.1:* Place jumper wire from TB1 (2) to TB2 (7) and change A flag setting on transmitter to alarm on open to maintain settings for all transmitters to be the same.

**Table W7.1**

<b>Terminal Block (TB1)</b>	<b>To DigitalGrid's Termination</b>	<b>Wire Color</b>	<b>Purpose</b>	<b>Auxiliary Cable External to NWP</b>
TB1-1	na	na	+ 15 V	na
TB1-2	TB2-7	jumper wire	A INPUT	na
TB1-3	to the other side of auxiliary NWP position contact (B contact) that is closed when NWP is open)	white with blue stripe	B INPUT	na
TB1-4	auxiliary cable wire (Model DG-210) internal wiring	violet with white stripe	C INPUT	white on grey tagged auxiliary cable



**CONSTRUCTION GUIDELINE**

DigitalGrid NCS Transmitter Installation, Network Protectors

SUPERSEDING: new  
EFFECTIVE DATE: October 3, 2007

Terminal Block (TB1)	To DigitalGrid's Termination	Wire Color	Purpose	Auxiliary Cable External to NWP
TB1-5	auxiliary cable wire (Model DG-210) internal wiring	white with orange and black stripe	D INPUT	white on white tagged auxiliary cable
TB1-6	auxiliary cable wire (Model DG-210) internal wiring	white with green stripe	E INPUT	white on orange tagged auxiliary cable
TB1-7	auxiliary cable wire (Model DG-210) internal wiring	violet	F INPUT	white on violet tagged auxiliary cable
TB1-8	na	na	G INPUT	na
TB1-9	na	na	H INPUT	na
TB1-10	na	na	not used	na
TB1-11	auxiliary cable wire (Model DG-210) internal wiring	white with orange and red stripes	A1 REF	red on green tagged auxiliary cable
TB1-12	auxiliary cable wire (Model DG-210) internal wiring	white with brown and yellow stripes	A2 REF	red on blue tagged auxiliary cable
TB1-13	auxiliary cable wire (Model DG-210) internal wiring	white with black and red stripes	A1 INPUT	white on green tagged auxiliary cable
TB1-14	auxiliary cable wire (Model DG-210) internal wiring	white with green and black stripes	A2 INPUT	white on blue tagged auxiliary cable
TB1-15	auxiliary cable wire (Model DG-210) internal wiring	white with blue and brown stripes	A1 RTN	black on green tagged auxiliary cable
TB1-16	auxiliary cable wire (Model DG-210) internal wiring	white with orange and brown stripes	A2 RTN	black on blue tagged auxiliary cable

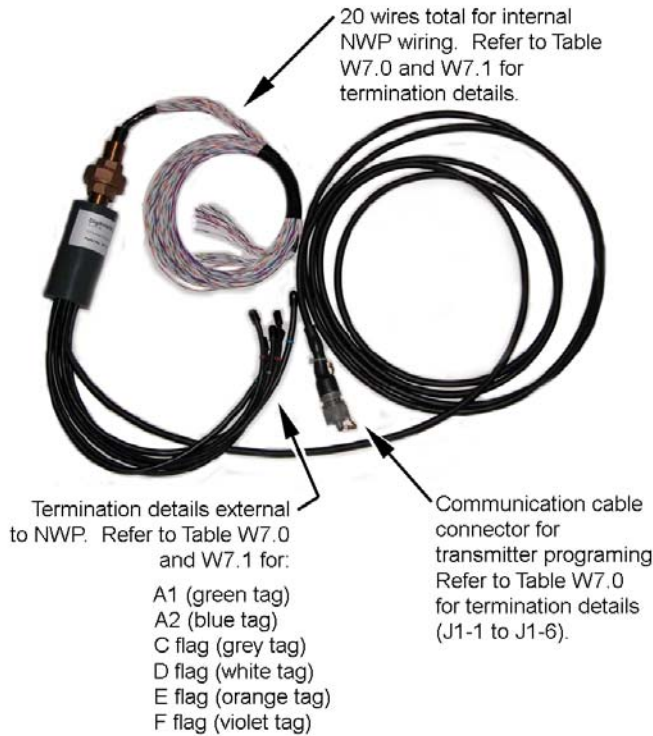

**Photo W7 – NCS Auxiliary Cable Harness Model No. DG-210**

**CONSTRUCTION GUIDELINE**

DigitalGrid NCS Transmitter Installation, Network Protectors

**W7.2 NCS Auxiliary Cable Harness Model No. DG-210 Assignment to Switch Sensors**

NCS Auxiliary Cable Harness Model No. DG-210 has four two-wire and two three-wire rubber-covered cables "break out" and can be routed separately to switch sensors located on the exterior of the transformer. Use switch terminals that are normally open (closed on detected abnormal condition) and seal the connections to make them waterproof. The six cables have the following color-coded sleeves and are used as follows:

**Table W7.2**

Flag Assignment	Color	Connected to:
C	grey	thermometer on transformer
D	white	unused
E	orange	oil level gage on transformer
F	violet	float switch
A1	green	external NWP temperature
A2	blue	internal/external NWP temperature

**W8.0 General NWP Wiring and Precautions**

Once the wiring within the NWP is completed it should be reinstalled into the casing and all the cables and wires just installed are to be inspected. Check all clearances so that the NWP can be racked in and out without cutting or crimping any wires. Use tie wraps to secure and dress loose wires. All the unused wires from the NCS Auxiliary Cable Harness should also be taped and secured as well. After a thorough visual inspection of the cable installation in the NWP, check all the clearances on all added sensors and wires. Be sure that the NWP under normal operation will not cut or damage any wires. All high voltage (120VAC or higher) wires between J1, P1, and the NCS Transmitter shall be individually verified. Correct any defects or errors.

**W9.0 Material List for Westinghouse Style NWP**

*Note W9.0:* The installation of an autotransformer is required when converting from 480Y/277V mechanical relays to 208Y/120V. The autotransformers are connected between the network and transformer sides, phases (1, 2, 3) and ground (see diagram W9).

**Table W9.0**

Item Number	Quantity	Description	Stock Number
1	1	Transmitter kit for Westinghouse style NWP, consists of:	012497
		a. DigitalGrid transmitter and cable harness	012495
		b. Load current sensor, CT, includes 3	012498
		c. Mounting hardware kit	012499
		d. Auxiliary cable harness	012167
2	1	Analog temperature sensor	012122
3	0 or 6	Autotransformer, for 480V transformers*	687730
4	50 ft	Cable wrap, polyethylene, 1/4 in.	735361
5	25 ft	Cable wrap, polyethylene, 1/2 in.	735363

\*Only the old style network protector with Electrical/Mechanical relay, 480/277V, and no step down, requires autotransformers. The newer style network protector with microprocessor relay, comes with a step down auto, therefore, autotransformers are not needed. For these newer relays, connect the transmitter to the back of the relay or terminal strip.

# CONSTRUCTION GUIDELINE

DigitalGrid NCS Transmitter Installation, Network Protectors

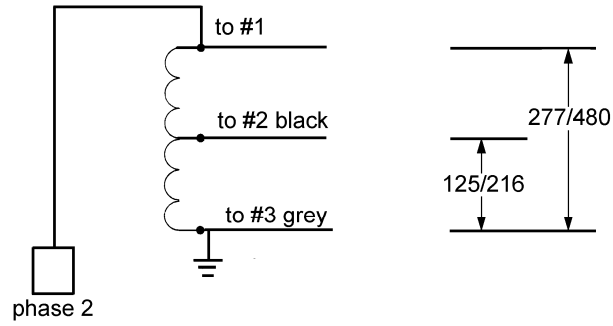

**Diagram W9 – Autotransformer Wire Connection**

# CONSTRUCTION GUIDELINE

DigitalGrid NCS Transmitter Installation, Network Protectors

SUPERSEDING: new  
EFFECTIVE DATE: October 3, 2007

## Section G: Transmitter Installation Inside GE Network Protectors

### G1.0 Introduction

This installation instruction provides mounting and wiring details for DigitalGrid, Inc.'s NCS Transmitter Kit No. DG-2000 KT-1 when being installed in a GE MG8 or MG9 Network Protector (NWP) or equivalent. The NCS Transmitter Kit will contain the following:

- G1.1** NCS Transmitter Model No. DG-2000 (See Photo G1)
- G1.2** Three (3) NCS Current Transformers (CTs) Model Nos. DG-400A, DG-400B, and DG-400C (See Photo G2)
- G1.3** NCS Wire Harness Model No. DG-200 (See Photo G3)
- G1.4** NCS Mounting Hardware Accessory Kit Model No. DG-020-1 (See Photo G4) that includes:
  - G1.4.1 Two (2) NCS Transmitter Mounting Thumb Nuts Part No. DG-5004
  - G1.4.2 Two (2) NCS Transmitter Mounting Bolts Part No. DG-5005
  - G1.4.3 Two (2) Adaptor Spacers Part No. DG-5006
  - G1.4.4 Two (2) #8 Bolts Part No. DG-5007
  - G1.4.5 Two (2) #8 Captivated Locks and Nuts Part No. DG-5008
  - G1.4.6 One (1) NCS Transmitter Mounting Bracket Part No. DG-5002 or DG-5012

As an option to the NCS Transmitter Kit, a NCS Auxiliary Cable Harness Model No. DG-210 (See Photo G5) may also be provided. Wiring instructions for this item is provided in this installation instruction.

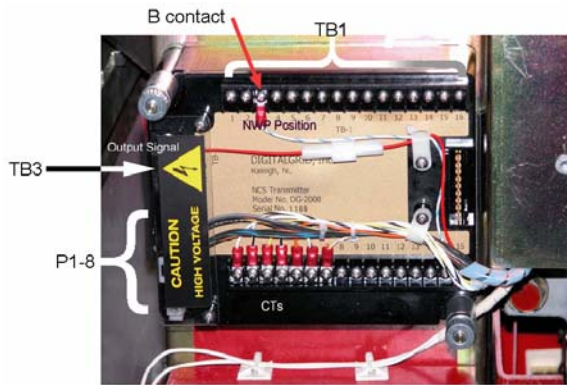

**Photo G1 – Wired NCS Transmitter  
Model No. DG-2000**



**Photo G2 – NCS CTs Model Nos. DG-400A,  
DG-400B, and DG-400C**

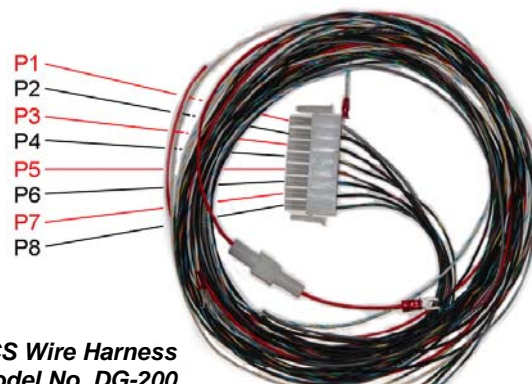

**Photo G3 – NCS Wire Harness  
Model No. DG-200**

**CONSTRUCTION GUIDELINE**

DigitalGrid NCS Transmitter Installation, Network Protectors

DigitalGrid, Inc.  
Raleigh, NCHardware Accessory Kit  
(excluding Mounting  
Bracket P/N DG-5001/2)  
Model No. DG-020  
Packing List

**Photo G4 – NCS Mounting HW Accessory Kit Model No. DG-020-1  
(excluding NCS Transmitter Mounting Bracket)**

**G2.0 NCS Transmitter Model No. DG-2000 Mounting Instruction**

DigitalGrid provides mounting hardware to allow the NCS Transmitter to be installed in a MG8 or MG9 NWP.

**G2.1 With Electrical/Mechanical Relays Installed**

- G2.1.1 Install two (2) NCS Transmitter Mounting Bolts Part No. DG-5005 from back side of NCS Transmitter Bracket Part No. DG-5002 or DG-5012.
- G2.1.2 Mount the NCS Transmitter Bracket on the right side of the protector frame using two (2) #8 Bolts Part No. DG-5007 and two (2) #8 Captivated Locks and Nuts Part No. DG-5008. Note: Holes on NCS Transmitter Bracket should align with holes on protector frame. Wider holes may be needed to be drilled on protector frame.
- G2.1.3 Install NCS Transmitter onto the two (2) NCS Transmitter Mounting Bolts and use the two (2) NCS Transmitter Mounting Thumb Nuts Part No. DG-5004 to secure to the NCS Transmitter Bracket.

**G2.2 With Microprocessor Relays Installed**

- G2.2.1 Install NCS Transmitter on existing relay studs located at front of NWP.
- G2.2.2 Use the two (2) Adaptor Spacers Part No. DG-5006 and the two (2) NCS Transmitter Mounting Thumb Nuts Part No. DG-5004 to secure to the NCS Transmitter.

**G3.0 NCS Wire Harness Model No. DG-200 Installation Instructions**

The NCS Wire Harness Model No. DG-200, shown in Photo G3, is supplied with one P1 connector that mates to the J1 connector of the NCS Transmitter Model No. DG-2000. The J1 connector is located in the lower left corner of the NCS Transmitter. The J1 connector is integral to the case of the NCS Transmitter. The NCS Wire Harness is also provided with one red wire for the NCS Transmitter output signal and two wires (white w/blue stripe and white w/yellow stripe) for the NWP position contact. Required wire lugs, tie wraps, and shields to support the installation are included. Wiring Instructions for all wires from the NCS Wire Harness are located in Section G5.0.

**G4.0 NCS CTs Model Nos. DG-400A, 400B, and 400C Installation Instructions**

The NCS CTs Model Nos. DG-400A, 400B, and 400C, shown in Photo G2, are encapsulated with a small hole in their center. Install the NCS CT Model No. DG-400A on the NWP CT for phase "A", the Model No. DG-400B on the NWP CT for phase "B" and so on by running the lead for the NWP CT or jumper through the hole in the center of the NCS CT. The NCS CTs are labeled and their leads color coded. Polarity of the NCS CT is identified by the arrow marked on the side of the NCS CT. It is critical that the NCS CT be installed such that the arrow on the side of the NCS CT is in the same direction as the current flow in the NWP CT lead or jumper wire that the NCS CT is installed on. Wiring instructions for the NCS CT wires are located in Section G5.0.

**CONSTRUCTION GUIDELINE**

DigitalGrid NCS Transmitter Installation, Network Protectors

**G5.0 NCS Transmitter Model No. DG-2000 Wiring Instructions**

Wiring instructions for the NCS Wire Harness Model No. DG-200 and NCS CTs Model Nos. DG-400A, DG-400B, and DG-400C to the NCS Transmitter Model No. DG-2000 are provided in the tables below.

**ALERT!**

**On a 277/480V network protector, the only 277V connection that is made for the transmitter output signal or red wire is terminated at TB-3. Also verify that the network protector is wired 1, 3, 2 to relay.**

**ALERT!**

**On a 277/480V network protector, verify this connection is made on the 120V side of PT.**

Table G5.0

NCS Transmitter Connector or Terminal Board Connection Location	Wire Color	Purpose	Wire Number (NWP Wire to Relay)	NWP Connection Location
P1-1	grey	ground	na	solid ground
P1-2	black	120VAC power for NCS transmitter	25	"B" phase on network side of NWP at rear test knob "E".
P1-3	black with red stripe	"A" phase network side voltage	15	"A" phase on network side of NWP at rear test knob "D".
P1-4	black with yellow stripe	"B" phase network side voltage	25	"B" phase on network side of NWP at rear test knob "E".
P1-5	black with orange stripe	"C" phase network side voltage	35	"C" phase on network side of NWP at rear test knob "F".
P1-6	black with blue stripe	"A" phase transformer side voltage	10	"A" phase on transformer side of NWP at rear test knob "K".
P1-7	black with violet stripe	"B" phase transformer side voltage	20	"B" phase on transformer side of NWP at rear test knob "L".
P1-8	black with green stripe	"C" phase transformer side voltage	30	"C" phase on transformer side of NWP at rear test knob "M".
TB-3-R (see Note G5.0)	red	transmitter output signal if 45KHz is selected	na	directly to "B" phase of the transformer side of the NWP
TB-3-B (see Note G5.0)	red	transmitter output signal if 50KHz is selected	na	directly to "B" phase of the transformer side of the NWP
TB-3-G (see Note G5.0)	red	transmitter output signal if 55KHz is selected	na	directly to "B" phase of the transformer side of the NWP
TB-3-Y (see Note G5.0)	red	transmitter output signal if 62KHz is selected	na	directly to "B" phase of the transformer side of the NWP

*Note G5.0:* The transmitter will be pre-wired with the red transmitter output signal wire on TB-3-G. If an output signal frequency other than 55KHz is used, open up the white disconnect installed on the red transmitter output signal wire (refer to Photo G1 which shows the white disconnect) prior to moving the signal wire from TB-3-G to the appropriate terminal board connection (TB-3-R, TB-3-B, or TB-3-Y). Once the wire is re-terminated, re-close the white disconnect.

**CONSTRUCTION GUIDELINE**

DigitalGrid NCS Transmitter Installation, Network Protectors

**G5.1 NCS CTs**

The following wiring instructions are for the NCS CTs. Prior to installing the NCS CTs, remove the three (3) shorting links between shorting posts 17 to 18, 27 to 28, and 37 to 38. Replace each shorting link with a 3 inch, 16 AWG, white, teflon jumper wire with the appropriate crimp lugs at each end.

To install the NCS CTs, place the appropriate jumper wire through the appropriate NCS CT (See table below). Place the NCS CT between the posts with the arrow on the NCS CT pointing in the same direction as the current flow (towards the network) through the jumper.

Once the NCS CTs are installed on jumpers, tape the two wires for each NCS CT together before running wires to the NCS Transmitter to verify proper connections are made at the NCS Transmitter.

**Table G5.1****NCS Transmitter  
Connector or  
Terminal Board  
Connection**

<b>Location</b>	<b>Wire Color</b>	<b>Purpose</b>	<b>NWP Connection Location</b>
TB-2-1	white	"A" phase current (CT X1)	from NCS CT Model No. DG-400A on jumper between posts 17 and 18
TB-2-2	white with black stripe	"A" phase current return (CT X1 RTN)	from NCS CT Model No. DG-400A on jumper between posts 17 and 18
TB-2-3	yellow	"B" phase current (CT X2)	from NCS CT Model No. DG-400A on jumper between posts 27 and 28
TB-2-4	white with black stripe	"B" phase current return (CT X2 RTN)	from NCS CT Model No. DG-400A on jumper between posts 27 and 28
TB-2-5	orange	"C" phase current or (CT X3)	from NCS CT Model No. DG-400A on jumper between posts 37 and 38
TB-2-6	white with black stripe	"C" phase current return (CT X3 RTN)	from NCS CT Model No. DG-400A on jumper between posts 37 and 38

*Note G5.1:* On GEs when installing RMs CTs on the wire to the relay socket, put the directional arrow for the RMs CT pointing electrically away from the relay.

**G6.0 NCS Auxiliary Cable Harness Model No. DG-210 Wiring Instructions and Additional A20 Terminal Block Wiring Details**

A NCS Auxiliary Cable Harness Model No. DG-210, shown in Photo G5, can be provided to allow connection between the NCS Transmitter Model No. DG-2000 and sensors located external to the NWP. The NCS Auxiliary Cable Harness also allows programming of the NCS Transmitter without opening the NWP. If a NCS Auxiliary Cable Harness has been provided, it should be wired per the table below.

**NOTE G6.0:** Verify multitap CTs are wired according to NTP-80.



**CONSTRUCTION GUIDELINE**

DigitalGrid NCS Transmitter Installation, Network Protectors

**Table G6.0**

Terminal Block (TB2)	Connection	Wire Color	Purpose	Auxiliary Cable External to NWP
TB2-7	jumper to TB1-2 (to one side of the auxiliary NWP position contact (B contact) that is closed when NWP is open)	white with yellow stripe	A/B RTN (NWP position contact)	na
TB2-8	auxiliary cable wire (Model DG-210) internal wiring	white with grey stripe/ white with brown stripe	C/D RTN	black on grey/black on white tagged auxiliary cable
TB2-9	auxiliary cable wire (Model DG-210) internal wiring	white with green and brown stripes/ white with violet stripe	E/F RTN	white on orange/white on violet tagged auxiliary cable
TB2-10	Auxiliary Cable wire (Model DG-210) Internal Wiring	na	G/H RTN	na
TB2-11	Auxiliary Cable wire (Model DG-210) Internal Wiring	white with brown and black stripes	+ 5VDC COM 2 RTN	J1-1
TB2-12	Auxiliary Cable wire (Model DG-210) Internal Wiring	white with red stripe	+ 5 VDC COM 2	J1-2
TB2-13	Auxiliary Cable wire (Model DG-210) Internal Wiring	white with grey and brown stripes	RX +	J1-3
TB2-14	Auxiliary Cable wire (Model DG-210) Internal Wiring	white with purple and black stripes	RX -	J1-4
TB2-15	Auxiliary Cable wire (Model DG-210) Internal Wiring	white with purple and brown stripes	TX +	J1-5
TB2-16	Auxiliary Cable wire (Model DG-210) Internal Wiring	white with black and blue stripes	TX -	J1-6

**G6.1 NCS Auxiliary Cable Harness Model No. DG-210 Wiring Instructions and Additional Terminal Block Wiring Details**

*Note G6.1:* Place jumper wire from TB1 (2) to TB2 (7) and change A flag setting on transmitter to alarm on open to maintain settings for all transmitters to be the same.

**Table G6.1**

Terminal Block (TB1)	To DigitalGrid's Termination	Wire Color	Purpose	Auxiliary Cable External to NWP
TB1-1	na	na	+ 15 V	na
TB1-2	TB2-7	white with yellow stripe	A INPUT	na
TB1-3	to the other side of auxiliary NWP position contact (B contact) that is closed when NWP is open)	white with blue stripe	B INPUT	na
TB1-4	auxiliary cable wire (Model DG-210) internal wiring	violet with white stripe	C INPUT	white on grey tagged auxiliary cable
TB1-5	auxiliary cable wire (Model DG-210) internal wiring	white with orange and black stripe	D INPUT	white on white tagged auxiliary cable

**CONSTRUCTION GUIDELINE**

DigitalGrid NCS Transmitter Installation, Network Protectors

SUPERSEDING: new  
EFFECTIVE DATE: October 3, 2007

Terminal Block (TB1)	To DigitalGrid's Termination	Wire Color	Purpose	Auxiliary Cable External to NWP
TB1-6	auxiliary cable wire (Model DG-210) internal wiring	wjwhite with green stripe	E INPUT	white on orange tagged auxiliary cable
TB1-7	auxiliary cable wire (Model DG-210) internal wiring	violet	F INPUT	white on violet tagged auxiliary cable
TB1-8	na	na	G INPUT	na
TB1-9	na	na	H INPUT	na
TB1-10	na	na	not used	na
TB1-11	auxiliary cable wire (Model DG-210) internal wiring	white with orange and red stripes	A1 REF	red on green tagged auxiliary cable
TB1-12	auxiliary cable wire (Model DG-210) internal wiring	white with brown and yellow stripes	A2 REF	red on blue tagged auxiliary cable
TB1-13	auxiliary cable wire (Model DG-210) internal wiring	white with black and red stripes	A1 INPUT	white on green tagged auxiliary cable
TB1-14	auxiliary cable wire (Model DG-210) internal wiring	white with green and black stripes	A2 INPUT	white on blue tagged auxiliary cable
TB1-15	auxiliary cable wire (Model DG-210) internal wiring	white with blue and brown stripes	A1 RTN	black on green tagged auxiliary cable
TB1-16	auxiliary cable wire (Model DG-210) internal wiring	white with orange and brown stripes	A2 RTN	black on blue tagged auxiliary cable

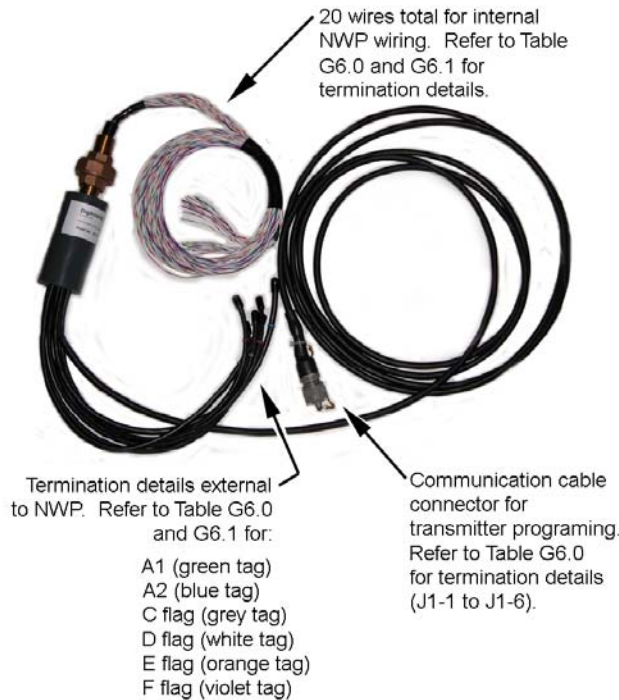

**Photo G6 – NCS Auxiliary Cable Harness Model No. DG-210**

**CONSTRUCTION GUIDELINE**

DigitalGrid NCS Transmitter Installation, Network Protectors

**G6.2 NCS Auxiliary Cable Harness Model No. DG-210 Assignment to Switch Sensors**

NCS Auxiliary Cable Harness Model No. DG-210 has four two-wire and two three-wire rubber-covered cables "break out" and can be routed separately to switch sensors located on the exterior of the transformer. Use switch terminals that are normally open (closed on detected abnormal condition) and seal the connections to make them waterproof. The six cables have the following color-coded sleeves and are used as follows:

**Table G6.2**

Flag Assignment	Color	Connected to:
C	grey	thermometer on transformer
D	white	unused
E	orange	oil level gage on transformer
F	violet	float switch
A1	green	external NWP temperature
A2	blue	internal/external NWP temperature

**G7.0 General NWP Wiring and Precautions**

Once the wiring within the NWP is completed it should be reinstalled into the casing and all the cables and wires just installed are to be inspected. Check all clearances so that the NWP can be racked in and out without cutting or crimping any wires. Use tie wraps to secure and dress loose wires. All the unused wires from the NCS Auxiliary Cable Harness should also be taped and secured as well. After a thorough visual inspection of the cable installation in the NWP, check all the clearances on all added sensors and wires. Be sure that the NWP under normal operation will not cut or damage any wires. All high voltage (120VAC or higher) wires between J1, P1, and the NCS Transmitter shall be individually verified. Correct any defects or errors.

**G8.0 Material List for GE Style NWP****Table G8.0**

Item Number	Quantity	Description	Stock Number
1	1	Transmitter kit for GE style NWP, consists of:	012496
		a. DigitalGrid transmitter and cable harness	012495
		b. Load current sensor, CT, includes 3	012498
		c. Mounting hardware kit	012500
		d. Auxiliary cable harness	012167
2	1	Analog temperature sensor	012122
3	0	Autotransformer, for 480V transformers*	687730
4	50 ft	Cable wrap, polyethylene, 1/4 in.	735361
5	25 ft	Cable wrap, polyethylene, 1/2 in.	735363

\*Note: Autotransformers are not required in GE network protectors because they come with PTs.

**CONSTRUCTION GUIDELINE**

DigitalGrid NCS Transmitter Installation, Network Protectors

**Section S: Analog Temperature Sensors****S1.0 Analog Temperature Sensor, Digitalgrid Model DG-500 (Stock No. 012122)**

Install vault temperature sensors anytime a new transformer or new transmitter is added in the field.

Operating temperature of sensors:  $-10^{\circ}\text{C}$  to  $+125^{\circ}\text{C}$

The sensors may be installed on either the analog 1 input or the analog 2 input.

To be consistent, select analog 1 for vault temperature and analog 2 for inside protector temperature.

**Table S1.0 Temperature Sensor Wiring Details**

Sensor Wire Color	Harness Wire Source
<i>External Mount of Sensor Using ANALOG 1 Input</i>	
red	red wire on <b>violet</b> , tagged auxiliary cable
purple	white wire on <b>violet</b> , tagged auxiliary cable
black	black wire on <b>violet</b> , tagged auxiliary cable
<i>External Mount of Sensor Using ANALOG 2 Input</i>	
red	red wire on <b>blue</b> , tagged auxiliary cable
purple	white wire on <b>blue</b> , tagged auxiliary cable
black	black wire on <b>blue</b> , tagged auxiliary cable
<i>Mounting Inside Network Protector of Sensor Using ANALOG 2 Input</i>	
red	white / red
purple	white / orange
black	white / grey

**S1.1 Set Up**

Install the AC power plug (J2) to transmitter (P2).

Connect programming cable to the transmitter (P1).

Run transmitter programming software from PC per Appendix A, as referenced in operating handbook.

Reference the following sections, pages A3 and A4.

**S1.2 Transmitter Programming**

The information below is based on factory settings. Contact Network Engineering for new threshold values.

**ALARM**

Analog 1: thresh: 100 :Threshold temperature level for input 1

Analog 1: thresh: AE :Alarm Enable, set to on or off.

**ALARM**

Analog 2: thresh: 100 :Threshold temperature level for input 2

Analog 2: thresh: AE :Alarm Enable, set to on or off.

ANALOG 1 Threshold :Alarm will occur over or under a set threshold, over/under

ANALOG 2 Threshold :Alarm will occur over or under a set threshold, over/under

Program "analog 1 or 2" with the "thresh" number to convert to temperature sensor in degrees C output from the transmitter to get an alarm from the receiver. Set "thresh" number to alarm at 40 degrees C for vault temperature. Assign analog 1 unless specified by a Network engineer.

Disconnect programming cable from transmitter (P1).

**CONSTRUCTION GUIDELINE**

DigitalGrid NCS Transmitter Installation, Network Protectors

SUPERSEDING: new  
EFFECTIVE DATE: October 3, 2007**S2.0 Location of Analog Temperature Sensor for Ambient Temperature**

Install one analog sensor for every new transformer, per the following details. Existing transformers may be retrofitted per engineering job orders.

**S2.1** For all of the street transformer vaults:

The analog temperature sensor may be placed **above** the network protector, near the heat sensor location. Connect the sensor to the transmitter's analog 1 alarm. See Diagram S2.1. In the year 2005 and beyond, new NTP may be developed to enhance temperature readings for single transformer vaults (i.e., terminating the signal wire between the network protector fuse and the vault bus bars.).

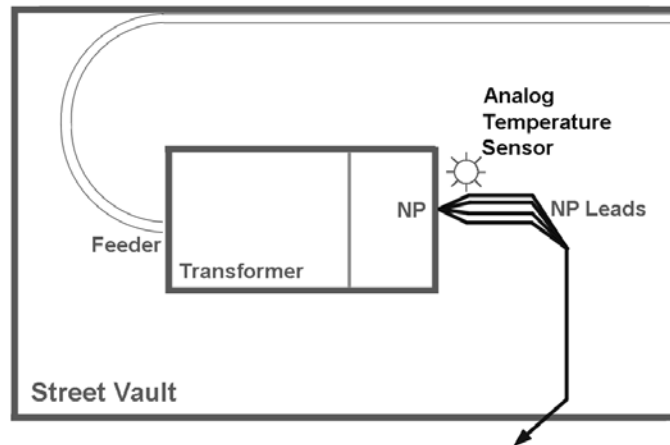
**Diagram S2.1 Street Transformer Vaults****S2.2** For New In-Building Vaults with Only One Transformer:

The analog temperature sensor may be placed **above** the network protector, near the heat sensor location. Connect the sensor to the transmitter's analog 1 alarm. See Diagram S2.2. In the year 2005 and beyond, new NTP may be developed to enhance temperature readings for single transformer vaults.

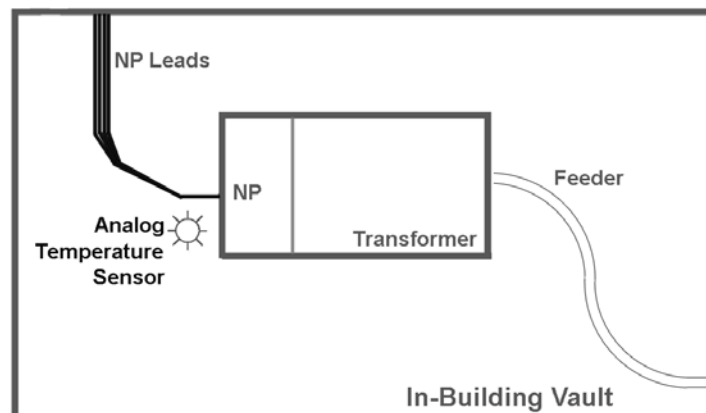
**Diagram S2.2 New, In-Building Vault - One Transformer**

**CONSTRUCTION GUIDELINE****S2.3** For In-Building Vault with Two or More Transformers:

Select any **two** transformers for the temperature sensor installation location. Place the temperature sensor **above** the network protector, near the heat sensor location. Connect the sensor to the transmitter's analog 1 alarm. See Diagram S2.3.

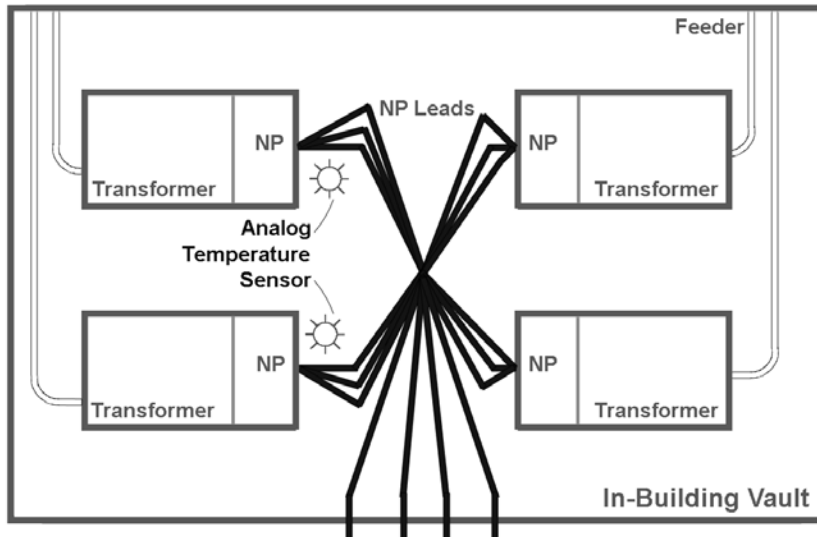

**Diagram S2.3 In-Building Vault - More than One Transformer**

**S3.0** Float Sensors

Stock Recommendations have been sent for new float sensors. Please contact Network Engineering for locations that may need float sensors. A probable installation point is at the bottom of the primary switch chamber (outside of the transformer).

**Section R: Reference**

- R1** "NCS Transmitter Kit Installation Instruction," Document No. DG2000KT1CM22, Rev No. 2, DigitalGrid, 11/4/2004
- R2** "NCS Transmitter Kit Installation Instruction," Document No. DG2000KT1MG8/9, Rev No. 3, DigitalGrid, 3/16/2005
- R3** NTP-80, Network Protector Fusing, Lead Sizes and Relays; SCL Network Construction Guideline
- R4** NTP-122, Hazeltine Model 2778 Transmitter Installation, Type "O3"; SCL Network Construction Guideline
- R5** Vendor communication, Tim MacCormac, DigitalGrid, 8307 Six Forks Road, Suite No. 107, Raleigh, North Carolina 27615, 919-844-4866, 9/4/2007