

814 Electric Vault, Primary Service

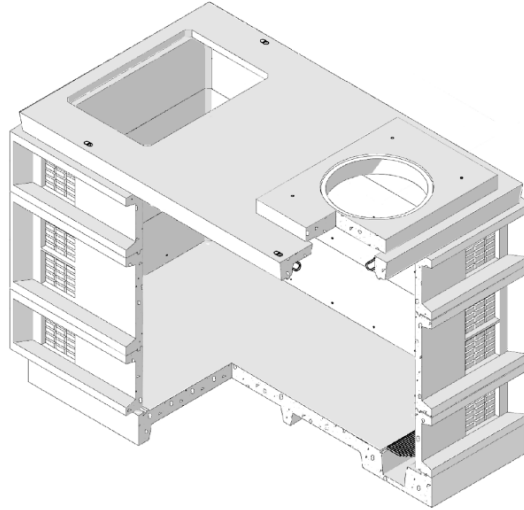

1. Table of Contents

2. Scope	1
3. Application	2
4. General Requirements	5
5. Base Requirements	5
6. Center Section Requirements	6
7. Top Section Requirements	7
8. Covers, Risers, and Hatches	9
9. Vault Assemblies	10
10. Shipping	25
11. Issuance	25
11. Approved Manufacturers	26
12. References	27
13. Sources	27

2. Scope

This standard covers the requirements for 814 electrical ring vault components (vault base, center sections (risers) and top sections) and assembled 814 electric vaults.

Most of the basic components can be ordered separately or they can be ordered as assembled vaults with covers.

This standard applies to the Seattle City Light (SCL) stock numbers listed in Section 12.

Due to their size, 814 vaults, components, and accessories will not be stocked in SCL inventory. Engineers and the Civil Crew Chief are required to order and specify delivery of these items.

Standard Coordinator
Laura Vanderpool

Standards Engineering Supervisor
John Shipek

Division Director
Tamara Jenkins

3. Application

814 vaults are used to construct the underground electric system. This precast concrete vault may be used to house medium size transformers up to 501 kVA, three-phase load break junction boxes, and service connections and splices for the distribution system.

The standard 8-ft high 814-vault assembly consists of the 814 vault base, two 48-in center sections (risers), a 814 top section with two 78-in by 50-in blockouts, various additional risers to bring access opening to grade, a cover with two 3-ft by 3-ft non-slip, solid hatches and a 42-inch entry access.

Due to different applications, the vault may need to be customized with tops with different block-out configurations, different combinations of center sections, various risers and access openings (see Figure 3).

Figure 3. Steps for selecting the proper vault assembly for your application:

Step 1. Select standard 814 vault base, [A] (Stock No. 013130, Section 5).

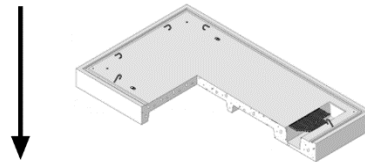

Step 2. Determine the height of vault needed, select any combination of 30-in [B1] or 48-in [B2] center sections (Stock Nos. 013131 and 013132, Section 6)

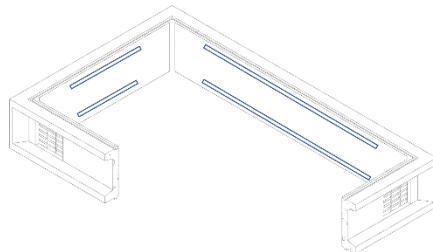

Stock No. 013131
B1 – 30-inch

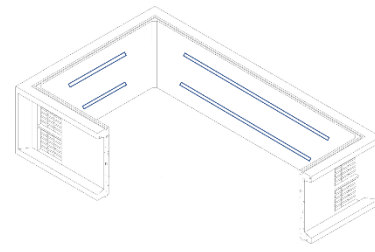

Stock No. 013132
B2 – 48-inch

Step 3. Determine and select the type of blockout configuration needed for the vault top section, [C1, C2 and C3]. For the 814 top sections there are 4 possible options each allowing a different set of access openings. Note, the top section allowing for two 42-in round access openings is not an option to be ordered separately but can be ordered as part of an assembly. Three top sections can be ordered separately. (Stock Nos. 013133, 013134 or 013135, Section 7).

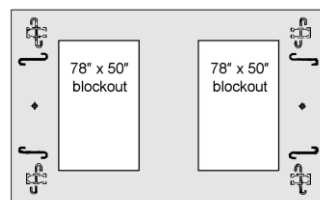

C1
 Stk#013133

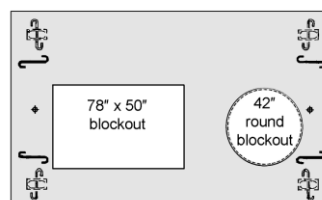

C2
 Stk#013134

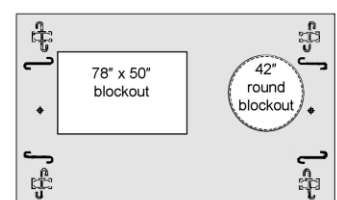

C3
 Stk#013135

Step 4. Select appropriate risers [D#] to bring access opening up to grade. Each riser section for the 814 covers half of the top section. (Stock Nos. 013105, 013106, 013162, 013107, 013108, and 013109).

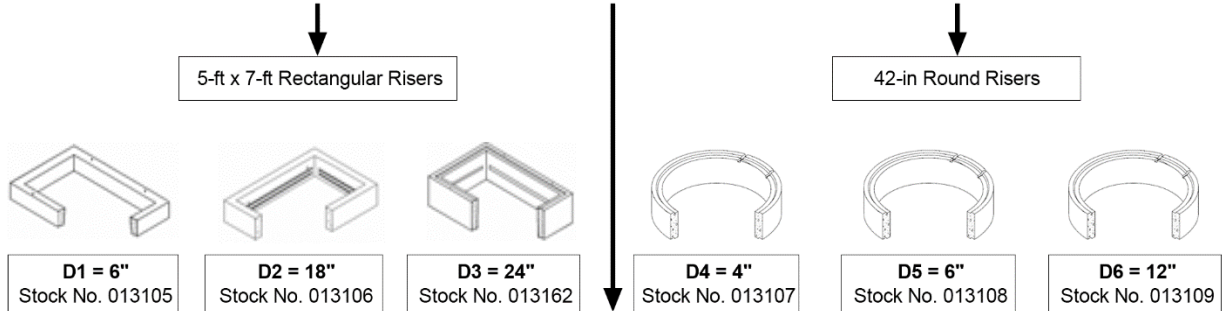

Step 5. Determine the appropriate type of covers and lids or hatches [E#]

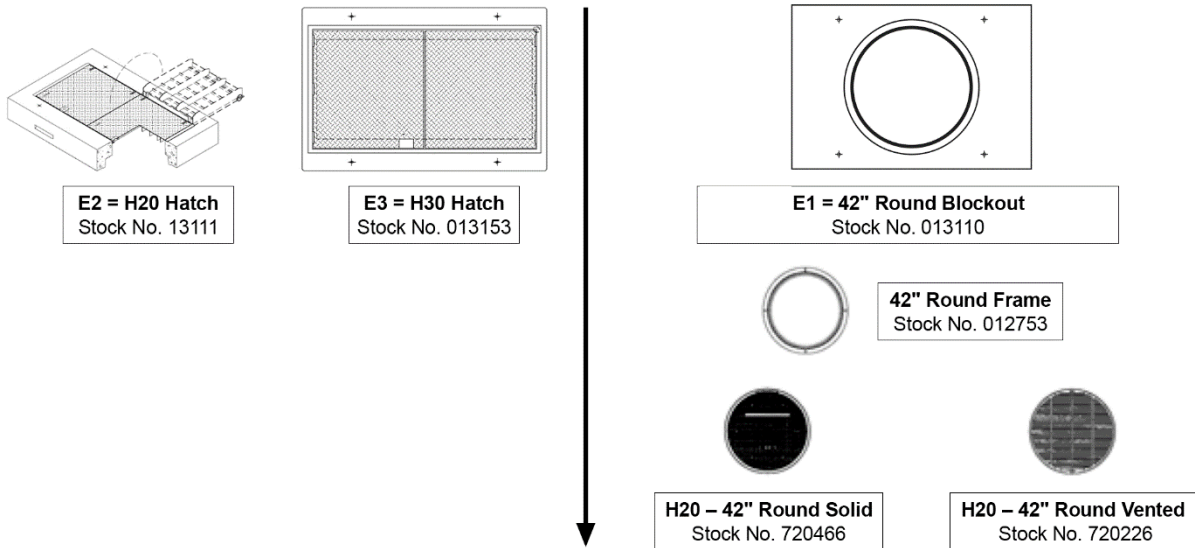

Step 6. Check the assembled vault configurations in Section 9 for vaults that can be ordered configured with base, top section, and covers. Assembled option will still require choices for risers and hatches or lids.

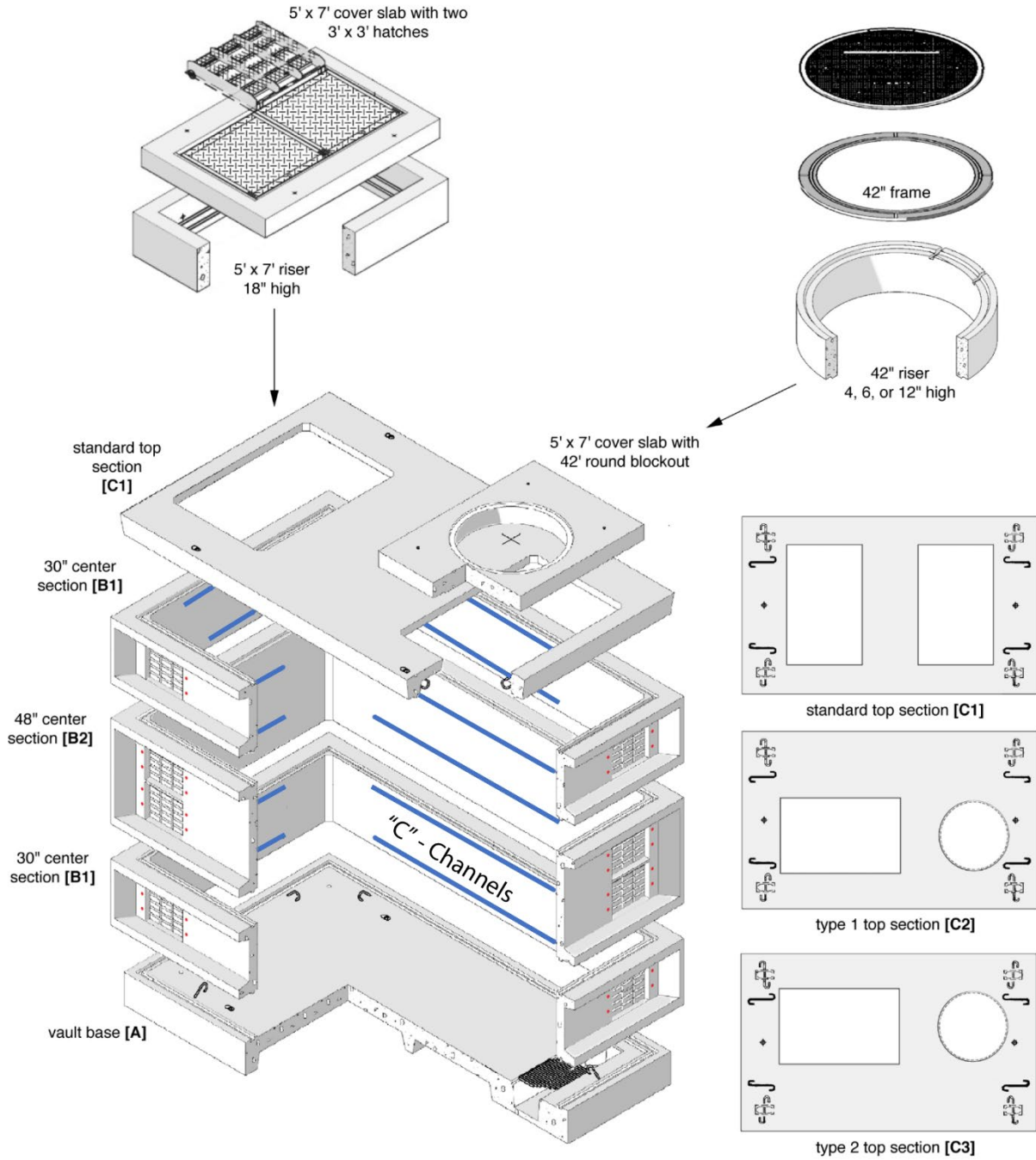

4. General Requirements

This standard is to be used in conjunction with SCL 7203.21, "Precast Reinforced Concrete Structures – General".

Vault grounding shall conform to SCL 7203.21, Section 9, Grounding.

Typical load rating for ring vaults is H-20; however, if heavy traffic is anticipated, engineer should request an H-25 load rating.

5. Base [A] Requirements

All 814 ring vault bases shall be constructed according to the dimensions shown in Table 5 and Figure 5.

The ring vault floor shall be sloped to drain toward the sump.

Table 5. Nominal Base Dimensions

Stock No.	Outside (ft-in)		Inside (ft-in)		Height (ft-in)		Figure
	Length	Width	Length	Width	Outside	Inside	
013130	15-0	9-0	14-0	8-0	1-3	-	5

Figure 5. Standard Vault Base [A]

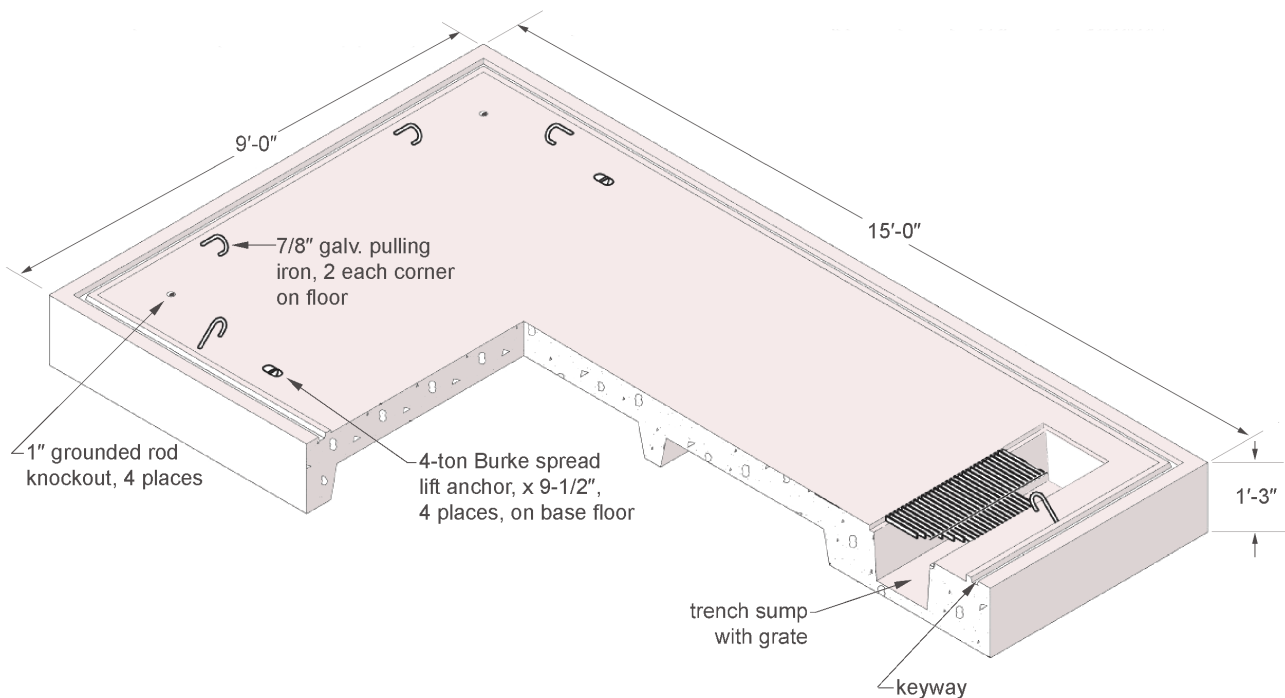

All 814 ring vault base shall have the following attributes:

- Ground rod knockout (1 inch diameter) at each corner of floor
- Trench sump with removable galvanized grating (12 in x 60 in); 1 ft from, and parallel to, short wall
- Pulling iron (7/8 in diameter); two (2) shall be located at each corner of floor, recessed in floor
- 4-ton lift anchors, one on each corner of floor
- Ground inserts (1/2 in) on opposite end walls on the floor
- Ladder; as required if vault floor is 12 ft-6 in or more below finish grade; fixed ladders shall be per SCL drawing D-28304; ladder substitution shall be submitted for approval

6. Center Section (Riser) Requirements [B1, B2]

All 814 ring vault center sections shall be constructed according to the dimensions shown in Table 6.

Table 6. Vault Nominal Center Sections Dimensions

Stock No.	Outside (ft-in)		Inside (ft-in)		Height (ft-in)		Figure
	Length	Width	Length	Width	Outside	Inside	
013131	15-7	9-7	14-0	8-0	2-6	-	6 [B1]
013132	15-7	9-7	14-0	8-0	4-0	-	6 [B2]

Note: Center sections are considered to be risers by manufacturers but in this Standard we use the term 'center section' to make a distinction from risers used above the top section for the purpose of adjusting the heights of covers to meet surface elevations (grade).

Figure 6. Vault Center Sections [B1 and B2]

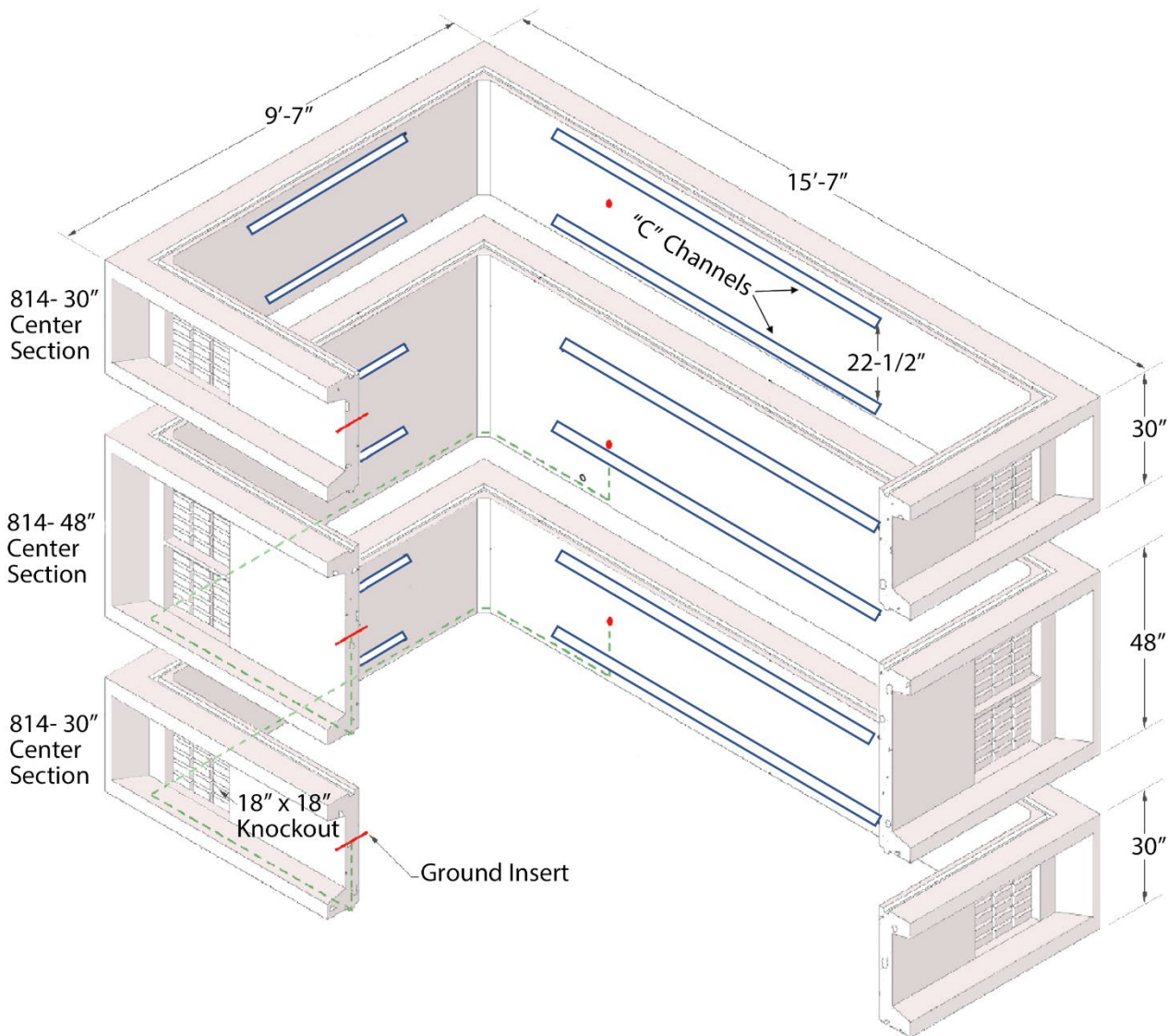

6.1 Knockouts, Waffle

Knockouts shall be of the waffle type.

For a 30-in high vault section **[B1]** (Stock No. 013131, knockout shall measure 18 in by 18 in. Knockouts shall be located on all 4 walls on the outer edge of the wall, two (2) on each side, for a total of eight (8) knockouts.

For a 48-in high vault section **[B2]** (Stock No. 013132), knockout shall measure 15 in by 18 in. Knockouts shall be located on all 4 walls on the outer edge of the wall, four (4) on each side, for a total of 16 knockouts.

6.2 Dowel Inserts

Dowel inserts (duct bank knockout inserts) shall be embedded 12 inches on center, around the perimeter of the knockout. Dowel inserts shall accommodate a 1/2-in diameter threaded rebar or steel dowel.

6.3 Channels

Galvanized "C" channels shall be embedded in vault walls between knockouts, centered, with 22.5-in spacing between rows.

Channels shall measure 1-5/8 in by 7/8 in by 48 in on the end walls and 1-5/8 in by 7/8 in by 120 in on the side walls.

6.4 Lift Anchors

Lift anchors shall be located at the corner of each wall.

Lift anchors shall have a lifting strength of four (4) tons.

6.5 Ground Inserts

Material shall be bronze. Ground inserts shall measure 1/2 inch in diameter. Four (4) total inserts shall be used, two (2) each located at the center of both internal and external side walls.

7. Top Section Requirements, [C1], [C2] and [C3]

All 814 top sections shall be constructed according to the dimensions shown in Table 7 and Figures 7a and 7b.

Table 7. Nominal Top Sections Dimensions and Weight

Stock No.	Top Sections (ft-in)			Blockout Configurations	Figure
	Length	Width	Thickness (in)		
013133	15-2	9-2	9.5	Two 78-in x 50-in blockouts [C1]	7a & 7b [C1]
013134	15-2	9-2	9.5	One 78-in x 50-in blockouts and one 42-in round blockouts, offset to left (Type 1) [C2]	7a & 7b [C2]
013135	15-2	9-2	9.5	One 78-in x 50-in blockouts and one 42-in round blockouts, offset to right (Type 2) [C3]	7a & 7b [C3]

Notes

- Type 1** refers to a left-offset rectangular blockout from point-of-view of round blockout end.
- Type 2** refers to a right-offset rectangular blockout from point-of-view of round blockout end.

Figure 7a. Vault Top Section [C1]

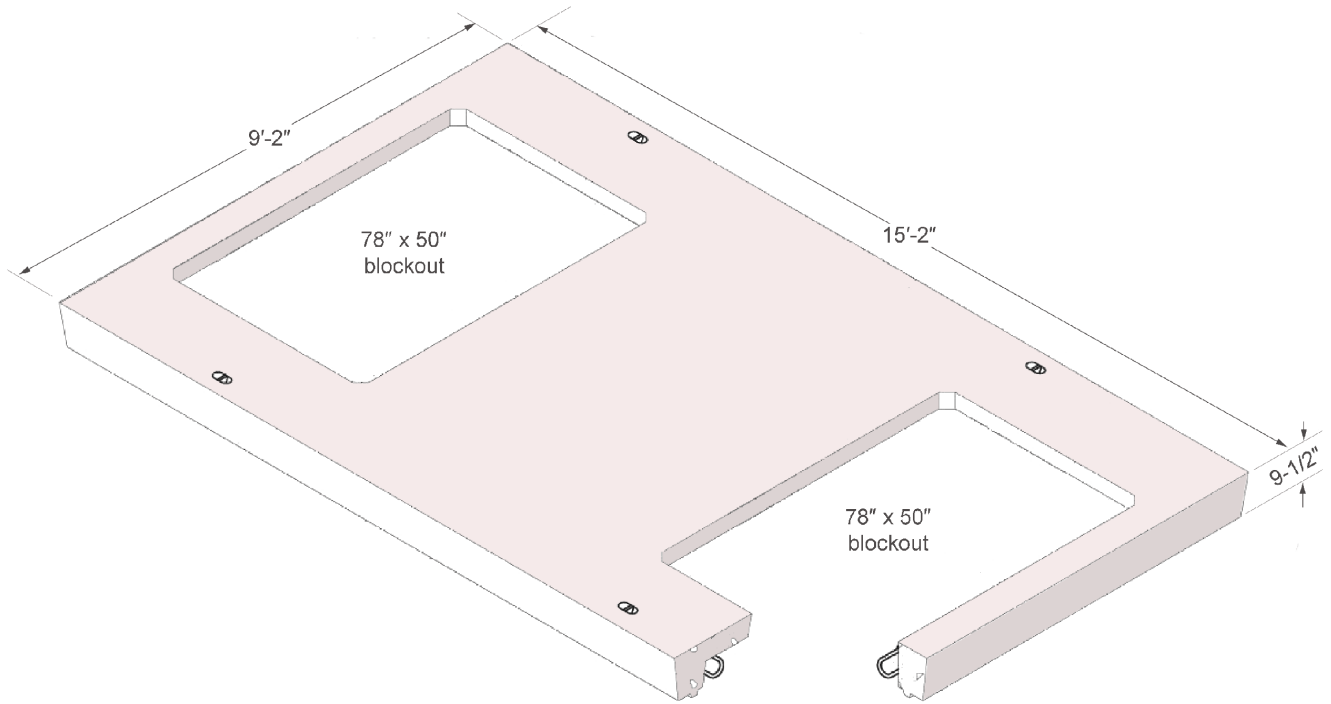
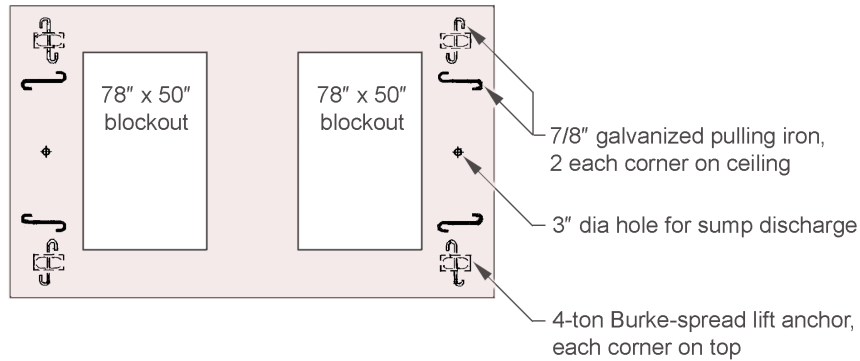
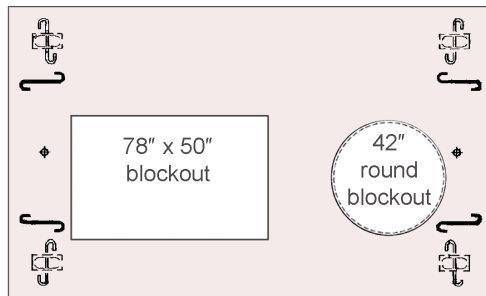

Figure 7b. Vault Top Section Blockout Options

814 Standard Top, Stock No. 013133 [C1]



814 Type 1 Top, Stock No. 013134 [C2], blockout offset to left



814 Type 2 Top, Stock No. 013135 [C3], blockout offset to right

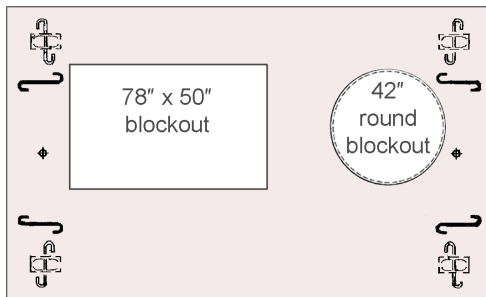

All 814 ring vault top covers shall have the following features:

- Pulling iron (7/8 in diameter); two (2) shall be located at each corner of ceiling
- 4-ton lift anchors, one on each corner of floor
- One access port (3 in diameter) shall be located at the center of each ends of top cover

8. Covers, Risers, and Hatches

Risers described in this section are designed to be set on the vault top section or on the cover for the purpose of adjusting the height of the vault access entrance to meet surface elevations (grade).

For a detailed material standard for covers and risers used with the 814 vault, refer to SCL 7204.15, "Covers and Risers for Electric Vaults."

For a detailed material standard for 42-inch round cover and frames, refer to SCL 7204.70, "Frame and Covers, 42-Inch Round, Iron."

Table 8. Covers, Risers, and Hatches

Stock No.	Description	Matl. Std.	References to Figure 3
013105	5-ft x 7-ft x 6-in riser without galvanized "C" channel	7204.15	D1
013106	5-ft x 7-ft x 18-in riser with galvanized "C" channels	7204.15	D2
013362	5-ft x 7-ft x 24-in riser with galvanized "C" channels	7204.15	D3
013107	42-in diameter by 4-in high round riser	7204.15	D4
013108	42-in diameter by 6-in high round riser	7204.15	D5
013109	42-in diameter by 12-in high round riser	7204.15	D6
013110	5-ft x 7-ft cover with one 42-in round access opening	7204.15	E1
013111	5-ft x 7-ft adjustable cover with two 3-ft x 3-ft non-slip solid hatches	7204.15	E2
013153	5-ft x 7-ft cover with two H-30 solid hatches	7204.15	E3
012753 and 720466	42-in frame with 42-in solid cover	7204.70	
012753 and 720226	42-in frame with 42-in grated vent cover	7204.70	

Rectangular blackout: For all top sections with rectangular openings covers are necessary, one for each top section rectangular blackout. Covers may either be set directly on the top section or may be set on risers. Covers shall be produced with a key shape on the bottom to fit into the 8-ft x 4 ft-6 in opening in the top section or in the riser openings. Risers are used to obtain the required elevation and then topped by the covers. In that case the risers are set with the blackout hole in the top section matching the opening of the risers (the openings have the same dimension). No key system is required to mate the rectangular riser to the top section.

Round blackout: Covers with 42-in round access holes may be set in grout directly on the top section surface. Keyed round risers may also be set directly into top sections that have 42-in round blockouts. Round risers shall have keys that are matched in the top covers with round blockouts; the same type of matching keys are required in covers with round blockouts.

9. Vault Assemblies

Seattle City Light has specified fourteen 814 vault assemblies that can be ordered by stock number. The predefined assemblies have three interior vault heights of 8, 9, or 10 feet with several options for overall height and type of access openings (see Table 9q).

The vault base and the vault top section shall have keyways for proper assembly.

Vaults shall be delivered to the job site, unless otherwise requested in purchase order.

Refer to Tables 9a – 9p for the various components included in each vault assemblies.

For all vault assemblies, if vault contains more than 75 kVA of transformer capacity, a vented (grate) cover (Stock No. 720226) is required in place of the solid cover (Stock No. 720466) per Table 9a.

Table 9a. 42-in Vented Cover

Stock No.	Description	Figure
720226	42-in H20 vented cover	

Table 9b. 8-ft Vault Assembly 013136: With 1 Equip. (72 in x 36 in) and 1 Personnel (42-in Round Hatch) [A-C1]



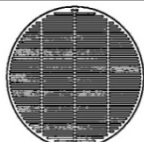

Component	Description	Label	Stock No.	Quantity	Figure
Base		A	013130	1	
Mid-Section Riser	48 in	B2	013132	2	
Top Section	814 with 2 rectangular blockout	C1	013133	1	
Rectangular Riser	18 in	D2	013106	1	
42-in Round Riser	4 in	D4	013197	1	
42-in Round Riser	12 in	D6	013109	1	
42-in Round Blockout		E1	013110	1	
Cover with H20 Hatch		E2	013111	1	
42-in H25 8-Lug Frame			012753	1	
42-in Solid			720466	1	

Table 9c. 8-ft Vault Assembly 013137: With 1 Equip. (72 in x 36 in) and 1 Personnel (42-in Round Hatch) (Type 1); [A-C2]

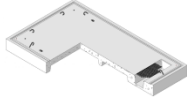
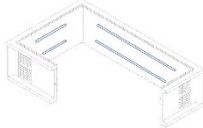
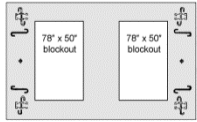
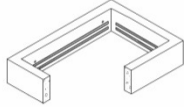
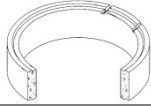
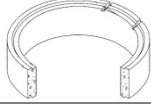
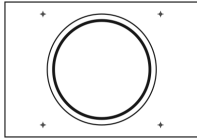

Component	Description	Label	Stock No.	Quantity	Figure
Base		A	013130	1	
Mid-Section Riser	48 in	B2	013132	2	
Top Section	814 with rectangular and 42-inch round blackout, Type 1, offset to left	C2	013134	1	
Rectangular Riser	18 in	D2	013106	1	
42-in Round Riser	4 in	D4	013197	1	
42-in Round Riser	12 in	D6	013109	1	
42-in Round Blockout		E1	013110	1	
Cover with H20 Hatch		E2	013111	1	
42-in H25 8-Lug Frame			012753	1	
42-in Solid			720466	1	

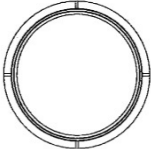
Table 9d. 8-ft Vault Assembly 013138: With 1 Equip. (72 in x 36 in) and 1 Personnel (42-in Round Hatch) (Type 2); [A-C3]

Component	Description	Label	Stock No.	Quantity	Figure
Base		A	013130	1	
Mid-Section Riser	48 in	B2	013132	2	
Top Section	814 with rectangular and 42-in round blockout, Type 2, offset to right	C3	013135	1	
Rectangular Riser	18 in	D2	013106	1	
42-in Round Riser	4 in	D4	013197	1	
42-in Round Riser	12 in	D6	013109	1	
42-in Round Blockout		E1	013110	1	
Cover with H20 Hatch		E2	013111	1	
42-in H25 8-Lug Frame			012753	1	
42-in Solid			720466	1	

Table 9e. 9-ft Vault Assembly 013139: With 1 Equip. (72 in x 36 in) and 1 Personnel (42-in Round Hatch) [A-C1]

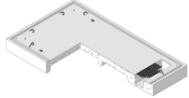
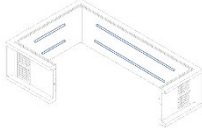
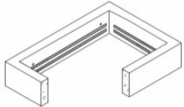
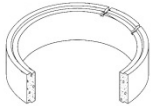
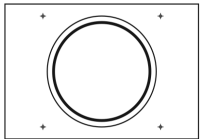

Component	Description	Label	Stock No.	Quantity	Figure
Base		A	013130	1	
Mid-Section Riser	30 in	B1	013131	2	
Mid-Section Riser	48 in	B2	013132	1	
Top Section	814 with 2 rectangular blockouts	C1	013133	1	
Rectangular Riser	18 in	D2	013106	1	
42-in Round Riser	4 in	D4	013197	1	
42-in Round Riser	12 in	D6	013109	1	
42-in Round Blockout		E1	013110	1	
Cover with H20 Hatch		E2	013111	1	
42-in H25 8-Lug Frame			012753	1	
42-in Solid			720466	1	

Table 9f. 9-ft Vault Assembly 013140: With 2 Personnel (42-in Round Hatch) [A-C1]

Component	Description	Label	Stock No.	Quantity	Figure
Base		A	013130	1	
Mid-Section Riser	30 in	B1	013131	2	
Mid-Section Riser	48 in	B2	013132	1	
Top Section	814 with 2 rectangular blockouts	C1	013133	1	
42-in Round Riser	4 in	D4	013197	2	
42-in Round Riser	12 in	D6	013109	2	
42-in Round Blockout		E1	013110	2	
42-in H25 8-Lug Frame			012753	2	
42-in Solid			720466	2	

Table 9g. 814 – 9 ft Vault Assembly 013141: With 1 Equip. (72 in x 36 in) and 1 Personnel (42-in Round Hatch) (Type 1); [A-C2]

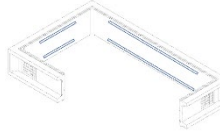
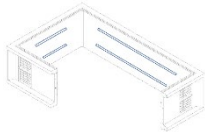
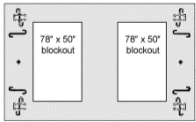
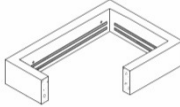
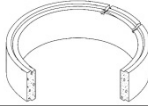
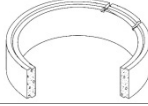
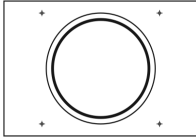
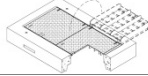
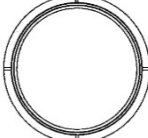

Component	Description	Label	Stock No.	Quantity	Figure
Base		A	013130	1	
Mid-Section Riser	30 in	B1	013131	2	
Mid-Section Riser	48 in	B2	013132	1	
Top Section	814 with rectangular and 42-in round blackout, Type 1, offset to left	C2	013134	1	
Rectangular Riser	18 in	D2	013106	1	
42-in Round Riser	4 in	D4	013197	1	
42-in Round Riser	12 in	D6	013109	1	
42-in Round Blockout		E1	013110	1	
Cover with H20 Hatch		E2	013111	1	
42-in H25 8-Lug Frame			012753	1	
42-in Solid			720466	1	

Table 9h. 9-ft Vault Assembly 013142: With 1 Equip. (72 in x 36 in) and 1 Personnel (42-in Round Hatch) (Type 2); [A-C3]

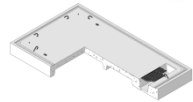
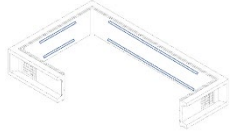
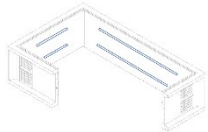
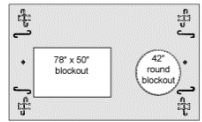
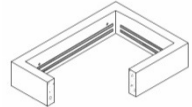
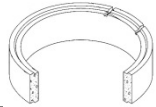
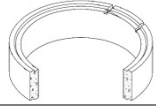
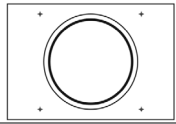
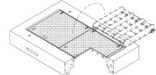
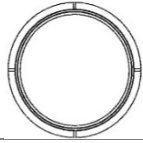

Component	Description	Label	Stock No.	Quantity	Figure
Base		A	013130	1	
Mid-Section Riser	30 in	B1	013131	2	
Mid-Section Riser	48 in	B2	013132	1	
Top Section	814 with rectangular and 42-inch round blackout, Type 2, off-set to right	C3	013135	1	
Rectangular Riser	18 in	D2	013106	1	
42-in Round Riser	4 in	D4	013197	1	
42-in Round Riser	12 in	D6	013109	1	
42-in Round Blockout		E1	013110	1	
Cover with H20 Hatch		E2	013111	1	
42-in H25 8-Lug Frame			012753	1	
42-in Solid			720466	1	

Table 9i. 10-ft Vault Assembly 013143: With 1 Equip. (72 in x 36 in) and 1 Personnel (42-in Round Hatch) [A-C1]



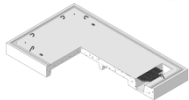
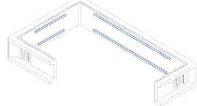
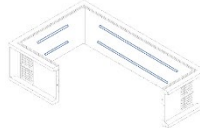
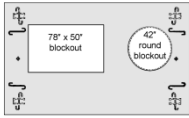
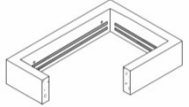
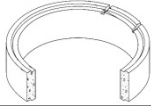
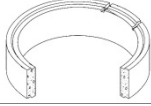
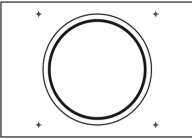
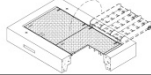
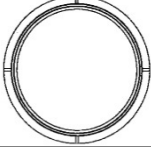

Component	Description	Label	Stock No.	Quantity	Figure
Base		A	013130	1	
Mid-Section Riser	30 in	B1	013131	4	
Top Section	814 with 2 rectangular blockout	C1	013133	1	
Rectangular Riser	18 in	D2	013106	1	
42-in Round Riser	4 in	D4	013197	1	
42-in Round Riser	12 in	D6	013109	1	
42-in Round Blockout		E1	013110	1	
Cover with H20 Hatch		E2	013111	1	
42-in H25 8-Lug Frame			012753	1	
42-in Solid			720466	1	

Table 9j. 10-ft Vault Assembly 013144: With 2 Personnel (42-in Round Hatch) [A-C1]

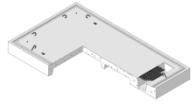
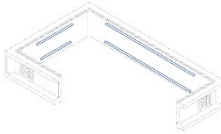
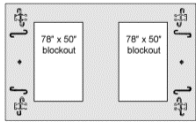
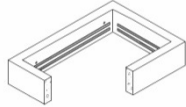
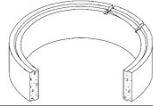
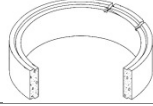
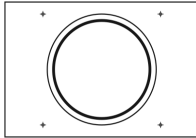

Component	Description	Label	Stock No.	Quantity	Figure
Base		A	013130	1	
Mid-Section Riser	30 in	B1	013131	4	
Top Section	814 with 2 rectangular blockout	C1	013133	1	
42-in Round Riser	4 in	D4	013197	2	
42-in Round Riser	12 in	D6	013109	2	
42-in Round Blockout		E1	013110	2	
42-in H25 8-Lug Frame			012753	2	
42-in Solid			720466	2	

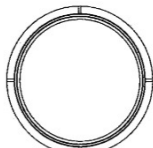
Table 9k. 10-ft Vault Assembly 013145: With 1 Equip. (72 in x 36 in) and 1 Personnel (42-in Round Hatch) (Type 1); [A-C2]

Component	Description	Label	Stock No.	Quantity	Figure
Base		A	013130	1	
Mid-Section Riser	30 in	B1	013131	4	
Top Section	814 with rectangular and 42-inch round blockout, Type 1, off-set to left	C2	013134	1	
Rectangular Riser	18 in	D2	013106	1	
42-in Round Riser	4 in	D4	013197	1	
42-in Round Riser	12 in	D6	013109	1	
42-in Round Blockout		E1	013110	1	
Cover with H20 Hatch		E2	013111	1	
42-in H25 8-Lug Frame			012753	1	
42-in Solid			720466	1	

Table 9I. 10-ft Vault Assembly 013146: With 1 Equip. (72 in x 36 in) and 1 Personnel (42-in Round Hatch) (Type 2); [A-C3]

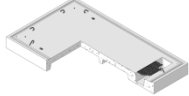
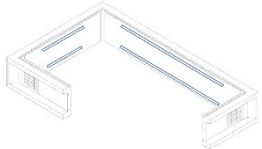
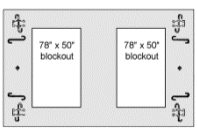
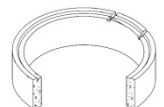
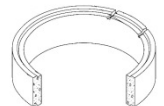
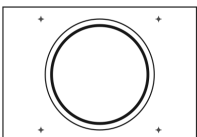
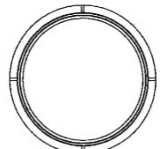

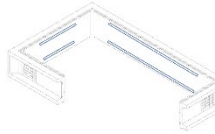
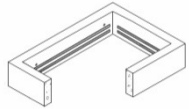
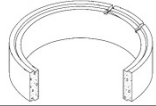
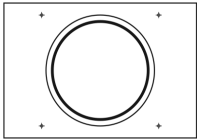

Component	Description	Label	Stock No.	Quantity	Figure
Base		A	013130	1	
Mid-Section Riser	30 in	B1	013131	4	
Top Section	814 with rectangular and 42-inch round blackout, Type 2, offset to right	C3	013135	1	
Rectangular Riser	18 in	D2	013106	1	
42-in Round Riser	4 in	D4	013197	1	
42-in Round Riser	12 in	D6	013109	1	
42-in Round Blockout		E1	013110	1	
Cover with H20 Hatch		E2	013111	1	
42-in H25 8-Lug Frame			012753	1	
42-in Solid			720466	1	

Table 9m. 8-ft Vault Assembly 013161: With 1 H30 Equip. (72 in x 36 in) and 1 Personnel (42-in Round Hatch) [A-C1]

Component	Description	Label	Stock No.	Quantity	Figure
Base		A	013130	1	
Mid-Section Riser	48 in	B2	013132	2	
Top Section	814 with 2 rectangular blockout	C1	013133	1	
Rectangular Riser	18 in	D2	013106	1	
42-in Round Riser	4 in	D4	013197	1	
42-in Round Riser	12 in	D6	013109	1	
42-in Round Blockout		E1	013110	1	
Cover with H30 Hatch		E2	013153	1	
42-in H25 8-Lug Frame			012753	1	
42-in Solid			720466	1	

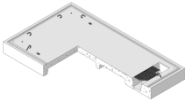
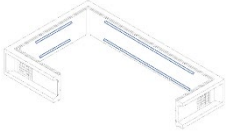
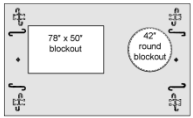
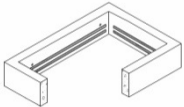
Table 9n. 8-ft Vault Assembly 013162: With 1 H30 Equip. (72 in x 36 in) and 1 Personnel (42-in Round Hatch) (Type 1); [A-C2]

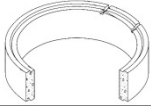
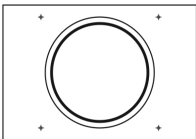
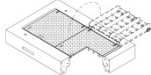
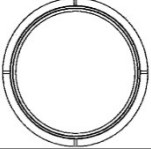

Component	Description	Label	Stock No.	Quantity	Figure
Base		A	013130	1	
Mid-Section Riser	48 in	B2	013132	2	
Top Section	814 with rectangular and 42-inch round blackout, Type 1, offset to left	C3	013134	1	
Rectangular Riser	18 in	D2	013106		
42-in Round Riser	4 in	D4	013197	1	
42-in Round Riser	12 in	D6	013109	1	
42-in Round Blockout		E1	013110	1	
Cover with H30 Hatch		E2	013153	1	
42-in H25 8-Lug Frame			012753	1	
42-in Solid			720466	1	

Table 9p. 8-ft Vault Assembly 013163: With 1 H30Equip. (72 in x 36 in) and 1 Personnel (42-in Round Hatch) (Type 2); [A-C3]

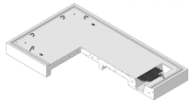
Component	Description	Label	Stock No.	Quantity	Figure
Base		A	013130	1	
Mid-Section Riser	48 in	B2	013132	2	
Top Section	814 with rectangular and 42-inch round blackout, Type 2, offset to right	C3	013135	1	
Rectangular Riser	18 in	D2	013106	1	
42-in Round Riser	4 in	D4	013197	1	
42-in Round Riser	12 in	D6	013109	1	
42-in Round Blockout		E1	013110	1	
Cover with H30 Hatch		E3	013153	1	
42-in H25 8-Lug Frame			012753	1	
42-in Solid			720466	1	

Table 9q. 8-ft Vault Assembly 014518: With 2 Personnel (42 in Round Hatch) [A C1]

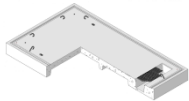
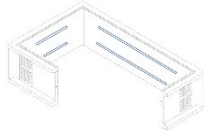
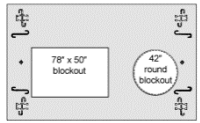
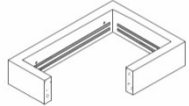
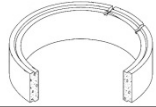
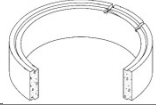
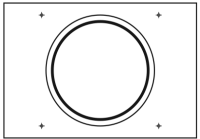
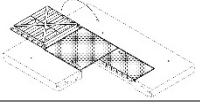
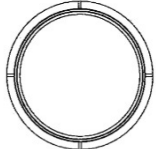

Component	Description	Label	Stock No.	Quantity	Figure
Base		A	013130	1	
Mid-Section Riser	48 in	B2	013132	2	
Top Section	814 with 2 rectangular blockouts	C1	013133	1	
42-in Round Riser	4 in	D4	013197	2	
42-in Round Riser	12 in	D6	013109	2	
42-in Round Blockout		E1	013110	2	
42-in H25 8-Lug Frame			012753	2	
42-in Solid			720466	2	

Table 9r. Vault Assembly Components and Overall Heights and Weight

Vault Assembly (ft)	Inside Height, Nominal	Outside Height ^a , Nominal	814 – 30R Risers	814 – 48R Risers	Vault Weight ^a , Nominal (lb)
8	8 ft-0 in	10 ft-5 in	-	2	51,700 lb
9	9 ft-0 in	11 ft-5 in	2	1	55,400 lb
10	10 ft-0 in	12 ft-5 in	4	-	59,100 lb

Note

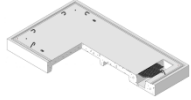
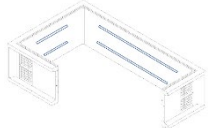
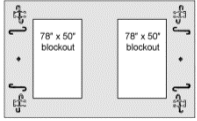
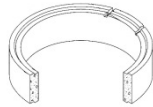
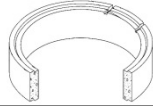
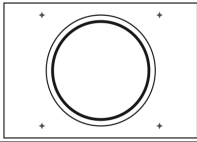
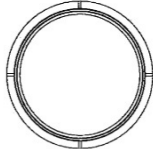
a. Height and weight do not include covers or additional risers to bring access to grade.

10. Shipping

All vaults larger than 444 shall be delivered to the job site. Contact SCL civil crew chief to arrange delivery details.

11. Issuance

Stock Unit: EA

12. Approved Manufacturers

Stock No.	Components	Manufacturer and Catalog No.
		Old Castle/ Utility Vault
013130	Standard vault base [A]	814 – SB
013131	30-in center section [B1]	814-30R w/ GRD
013132	48-in center section [B2]	814-48R w/ GRD
013133	Vault top section with two 76-in x 50-in blockouts [C1]	814-TEE-CLX
013134	Vault top section with one 76-in x 50-in and one 42-in round blockout, offset to left, Type 1 [C2]	814 Type 1 top
013135	Vault top section with one 76-in x 50-in and one 42-in round blockout, offset to right, Type 2 [C3]	814 Type 2 top
	Assemblies	
013136	8-ft high vault with one H-20 72-in x 36-in and one 42-in round entry access	814-8 CLX vault w/ GRD
013137	8-ft high vault with one 72-in x 36-in and one 42-in round entry access, offset to left (Type 1)	814-8 CLX Type 1 vault w/ GRD
013138	8-ft high vault with one 72-in x 36-in and one 42-in round entry access, offset to right (Type 2)	814-8 CLX Type 2 vault w/ GRD
013139	9-ft high vault with one 72-in x 36-in and one 42-in round entry access	814-9 CLX vault w/ GRD
013140	9-ft high vault with two 42-in round entry accesses	814-9 vault w/ 814-TEE-CLX top w/ (2) 42-in access holes w/ GRD
013141	9-ft high vault with one 72-in x 36-in and one 42-in round entry access, offset to left (Type 1)	814-9 CLX Type 1 vault w/ GRD
013142	9-ft high vault with one 72-in x 36-in and one 42-in round entry access, offset to right (Type 2)	814-9 CLX Type 2 vault w/ GRD
013143	10-ft high vault with one 72-in x 36-in and one 42-in round entry access	814-10 CLX vault w/ GRD
013144	10-ft high vault with two 42-in round entry accesses	814-10 vault w/ 814-TEE-CLX top w/ two 42-in access holes w/ GRD
013145	10-ft high vault with one 72-in x 36-in and one 42-in round entry access, offset to left (Type 1)	814-10 CLX Type 1 vault w/ GRD
013146	10-ft high vault with one 72-in x 36-in and one 42-in round entry access, offset to right (Type 2)	814-10 CLX Type 2 vault w/ GRD
013161	8-ft high vault with H-30 LW 2-door hatch and one 42-in round entry access	814-8 CLX vault w/ GRD w/ LW hatch
013162	8-ft high vault with H-30 LW 2-door hatch and one 42-in round entry access, offset to left (Type 1)	814-8 CLX Type 1 vault w/ GRD w/ LW hatch
013163	8-ft high vault with H-30 LW 2-door hatch and one 42-in round entry access, offset to right (Type 2)	814-8 CLX Type 2 vault w/ GRD w/ LW hatch
014518	8-ft high vault with two 42-in round entry accesses	814-8 vault w/ 814-TEE-CLX top w/ two 42-in access holes w/ GRD

13. References

SCL Material Standard 7203.21; "Precast Reinforced Concrete Structure, General"

SCL Material Standard 7204.15; "Covers and Risers for Electric Vaults"

SCL Material Standard 7204.70; "Frames and Covers, 42-Inch Round, Iron"

14. Sources

Ng, Sharon; SCL Civil Engineer and subject matter expert for 7203.51

Oldcastle Precast, 814 LA Center 30", Drawing Number 010-0190100-001; Rev. N, January 18, 2022

Oldcastle Precast, 814 LA Center 48", Drawing Number 010-0190120-001; Rev. N, January 18, 2022

Wang, Quan; SCL Standards Engineer, subject matter expert, and originator of 7203.51
www.oldcastleinfrastructure.com

Youngs, Rob; SCL Electrical Reviewer and subject matter expert for 7203.51