

**Clearances Between SCL Underground Assets and  
Non-SCL Structures and Objects**

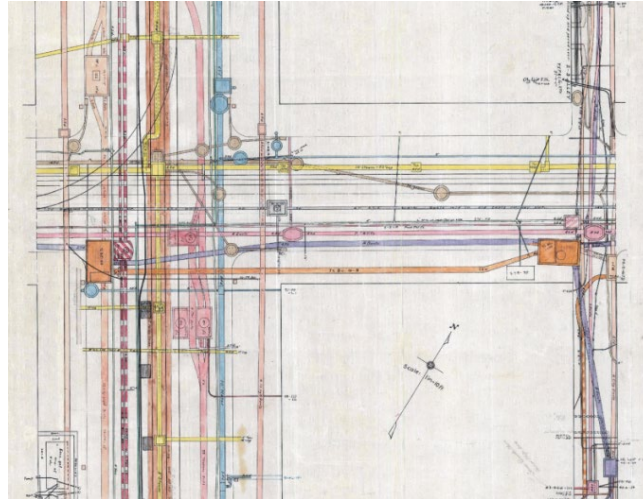

**1. Table of Contents**

2.	Scope .....	2
3.	Application .....	2
4.	SCL Vaults and Handholes in the Right-of-Way .....	3
4.1	Location and Orientation of 577 Vaults .....	3
4.2	Secondary Handhole Location and Orientation .....	6
4.3	Covers and Hatches .....	6
4.4	Vault Conduit Entry and Conduit Entry Zones .....	7
4.5	Clearances Between SCL Vaults or Handholes and Non-SCL Facilities, Conduits, and Pipes .....	9
4.6	Clearances Between SCL Structures and Vegetation .....	11
4.7	Other Clearances for Vaults and Handholes .....	12
5.	SCL Conduits and Duct Banks in the Right-of-Way .....	14
5.1	Clearances for 26 kV Conduits and Duct Banks .....	14
5.2	Clearances for 115 kV or 230 kV Conduits and Duct Banks .....	16
6.	Shoring Clearances .....	16
7.	Clearances for Wood Poles .....	16
8.	Clearances for SCL Facilities, Conduits, and Duct Banks on Private Property .....	17
9.	References .....	17
10.	Sources .....	17

Standard Coordinator  
Brett Hanson

Standards Engineering Supervisor  
Brett Hanson

Division Director  
Bob Risch

## 2. Scope

This standard covers clearance requirements between Seattle City Light (SCL) underground assets and non-SCL structures and objects. This includes assets in the public right-of-way, on private property, in the Network service area, and in the Looped Radial service area.

SCL underground assets include (but are not limited to):

- Vaults
- Covers and hatches
- Handholes
- Duct banks and duct runs
- Conduits
- Underground sections of wood poles

Non-SCL structures and objects include (but are not limited to):

- Basins
- Buildings
- Conduit (telephone, cable TV, fiber optic)
- Covers and hatches
- Fire hydrants
- Pipes (gas, water, sewer, steam)
- Root balls
- Street curbing
- Water meters

---

## 3. Application

This standard shall be used by SCL engineers, operations personnel, consultants, and contractors when designing and constructing vaults, handholes, and conduits below grade that are in the vicinities of other utilities installations. (Other utilities installations could be gas, water, sewer, steam, telephone, cable TV, and fiber optics.)

Other utilities and contractors should also follow these provisions when installing their facilities near any SCL facility.

Maintaining these minimum clearances allows enough space for future equipment maintenance (and future expansions and installations), minimizes the impact of other utilities failures on SCL equipment, allows for the repair and replacement of other utilities, prevents thermal interference, and ensures a safe environment for the public.

The minimum clearances defined in this document are per SCL specifications, which are derived from engineering and operations experience. The SCL specifications also take into account the City of Seattle Land Use Code, Right-of-Way Improvement Manual, Standard Plans and Specifications, SDOT Streets Illustrated, and the Washington Administrative Code (WAC).

For any deviation from the prescribed clearances, an agreement must be reached between SCL Engineering and the interested parties.

#### 4. SCL Vaults and Handholes in the Right-of-Way

##### 4.1 Location and Orientation of 577 Vaults

A 577 vault is typically used as a pulling vault or a loadbreak vault. The purpose of specifying the location and orientation of the vault is to ensure proper working space for SCL operations personnel.

The preferred orientation for a 577 vault is with the length of the vault perpendicular to the curb, as shown in Figure 4.1. For 577 vaults with junction boxes, additional clearances are required; see Figure 4.1.2.

**Figure 4.1. Preferred Location and Orientation for 577 Vault**

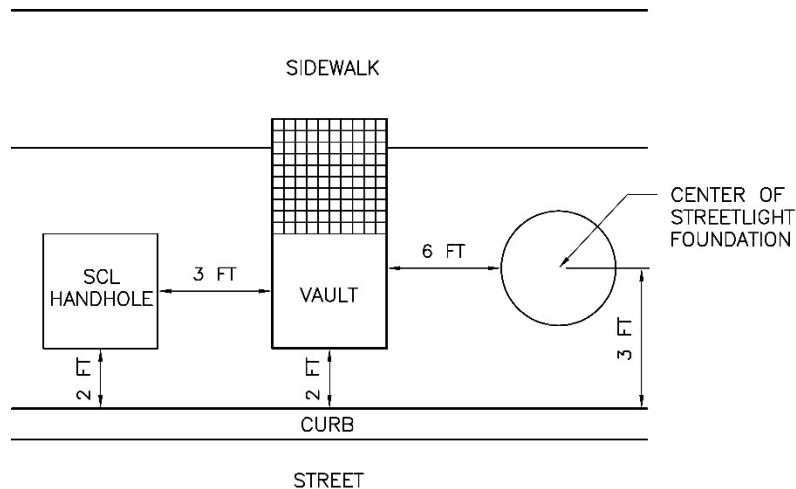

#### 4.1.1. Alternate Location and Orientation

The alternate orientation for a 577 vault is with the length of the vault parallel to the curb as shown in Figure 4.1.1. The location of the vault shall be entirely within the planting strip.

**Figure 4.1.1. Alternate Location and Orientation for 577 Vault**

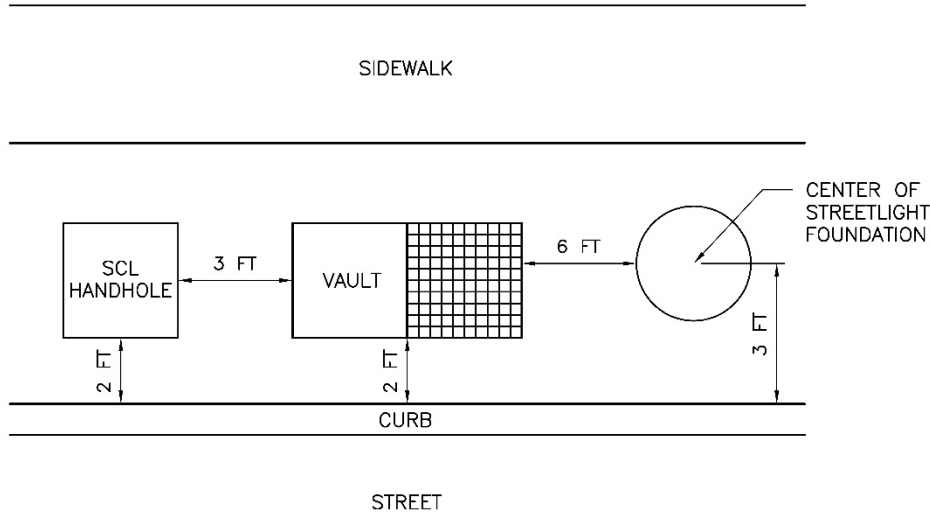

When vault or handhole extends into the sidewalk area because of a narrow planting strip, the vault or handhole shall be located entirely in the sidewalk with the edges flush with the street edge of the sidewalk and to the sidewalk grade. This applies only to the alternate location.

#### 4.1.2. Location and Orientation for 577 Vaults with Junction Boxes

Additional clearances required for 577 vaults with junction boxes are shown in Figure 4.1.2.

**Figure 4.1.2. Additional Clearances Required for 577 Vaults with Junction Boxes**

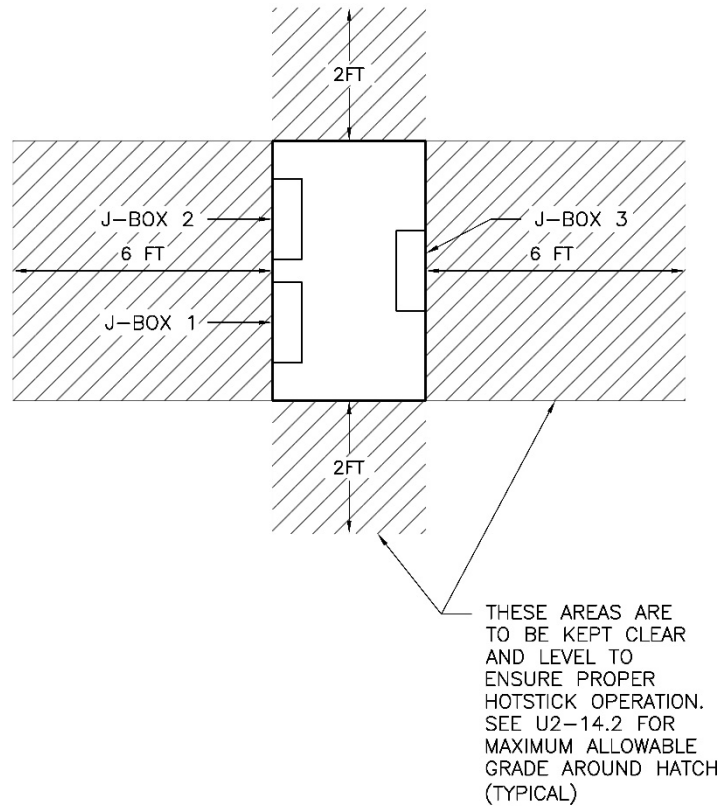

## 4.2 Secondary Handhole Location and Orientation

The secondary handhole shall be oriented with the long side of the handhole parallel to the curb. The lid shall open away from curbs and streets and avoid pedestrian and bike paths.

### 4.2.1. Preferred Location of Secondary Handhole

The preferred location is within the planting strip as shown in Figure 4.2.1.

**Figure 4.2.1. Preferred Location for Secondary Handhole**

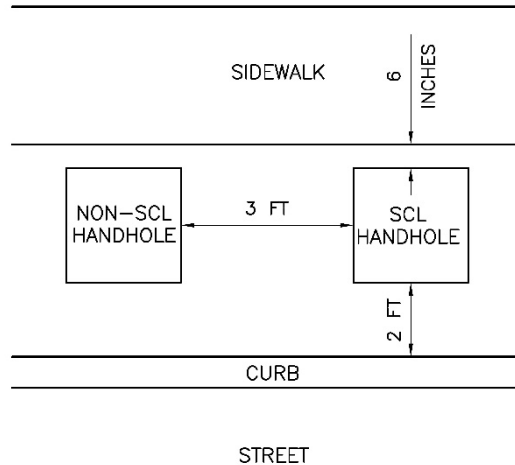

### 4.2.2. Alternate Location of Secondary Handhole

When there is lack of space in the planting strip, the alternate location for a secondary handhole is along the street side of the sidewalk, as shown in Figure 4.2.2.

Restore Sidewalk per requirement in City of Seattle Standard Plans for Municipal Construction, Standard Plan No. 420 or other Authority Having Jurisdiction (AHJ).

**Figure 4.2.2. Alternate Location for Secondary Handhole**

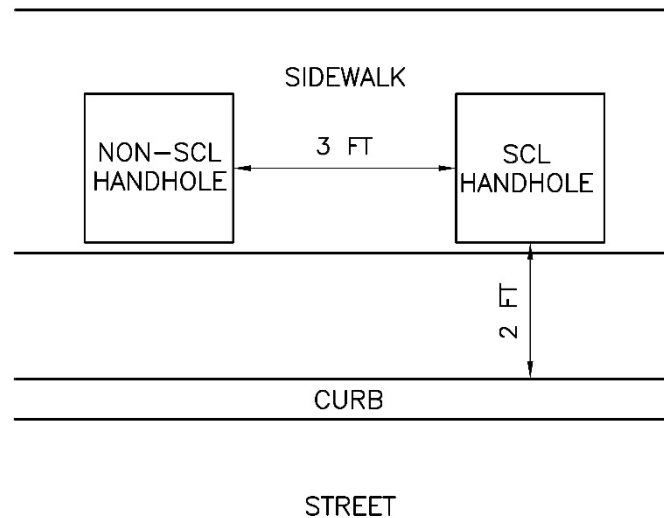

## 4.3 Covers and Hatches

When reviewing designs, engineers should take into account cover or lid size for future needs.

#### 4.4 Vault Conduit Entry and Conduit Entry Zones

Conduit entry zones shall be planned for future conduit extensions. These zones should be reserved for future extensions of SCL duct runs unless parties receive explicit permission from SCL Engineering.

The conduit entry zone shall be 8 ft long, and the width shall equal the width of the conduit entries plus 2 ft. The height of the conduit entry zone shall be equal to the height of the SCL facility.

No utility handholes or other underground structures shall be installed in conduit entry zones (the area outside and adjacent to conduit entries). See Figure 4.4a. Non-SCL utility vault construction in conduit entry zones shall be approved by SCL Engineering. See Figure 4.4a.

No installations below SCL facilities shall occur without written SCL Engineering approval. See Figure 4.4b.

No installations above other existing utilities' structures shall occur without written SCL Engineering approval. See Figure 4.4b.

**Figure 4.4a. Conduit Entry Zone, Plan View**

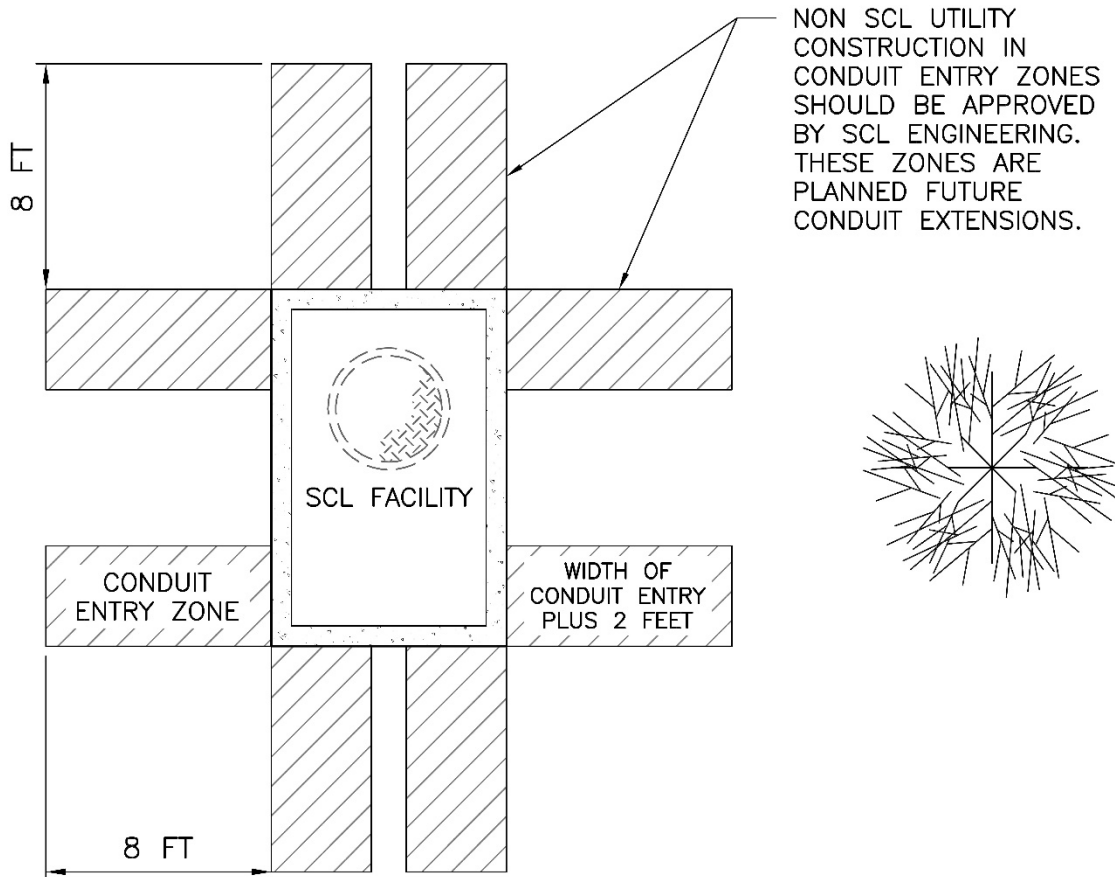

**Figure 4.4b. Conduit Entry Zone, Elevation View**

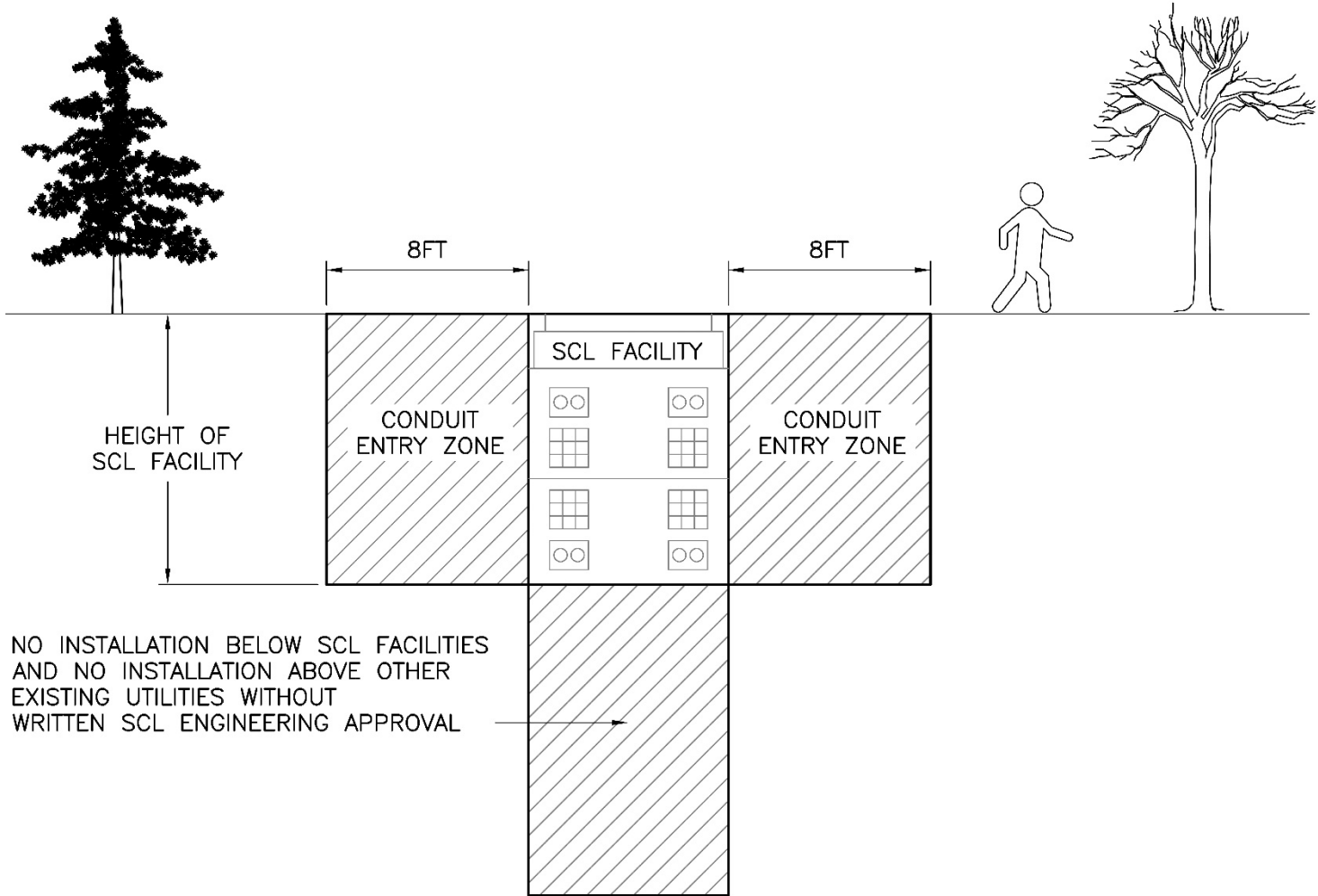



**4.5 Clearances Between SCL Vaults or Handholes and Non-SCL Facilities, Conduits, and Pipes**

See figures 4.5a and 4.5b for horizontal clearances between SCL Vaults or Handholes. Note that non-SCL conduit can be 3 ft from SCL facility when the conduit is located below the conduit entry zone (see figure 5b).

If SCL conduit entry zones are planned for 115 kV or 230 kV facilities, horizontal clearance shall be 5 ft from SCL facilities to non-SCL facilities and conduits, rather than 3 ft. Horizontal clearance for steam or heat sources shall remain 15 ft away from conduit entry zones planned for 115kV or 230 kV facilities.

**Figure 4.5a. Horizontal Clearances, Plan View**

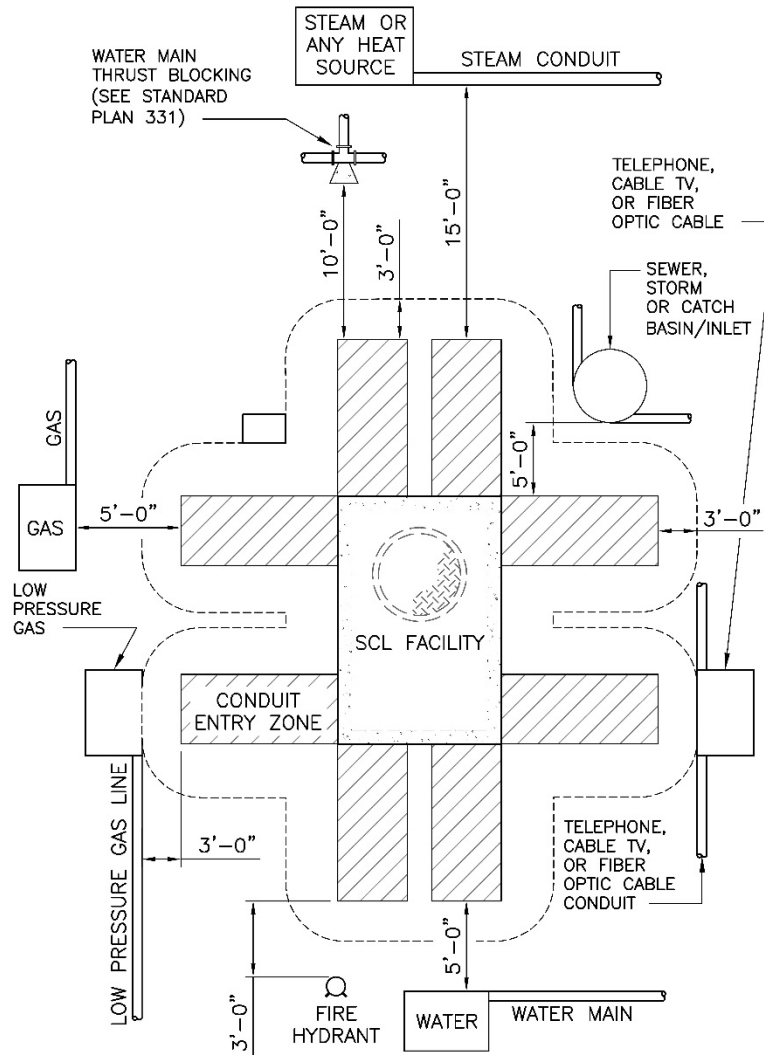

**Figure 4.5b. Horizontal Clearances, Elevation View**

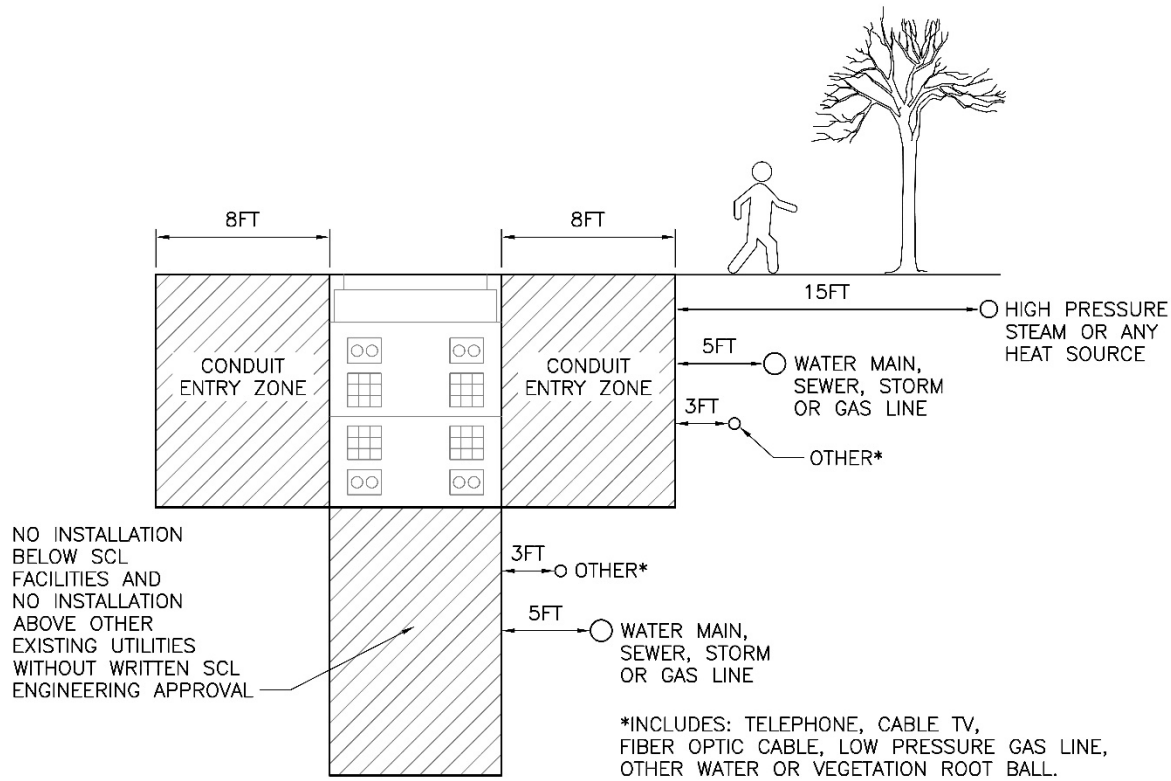

Note: If SCL conduit entry zones are planned for 115 kV or 230 kV, horizontal clearance shall be at least 5 feet between SCL conduit entry zones and non-SCL conduit or pipes.

#### 4.6 Clearances Between SCL Structures and Vegetation

There shall not be any planted trees, bushes, or shrubbery within 2 ft of SCL vaults, handholes, conduits, and duct banks. For vaults and handholes, the distance shall be measured from the vegetation's root ball to the structure's conduit entry zone.

**Figure 4.6a. Vegetation Clearances, Plan View**

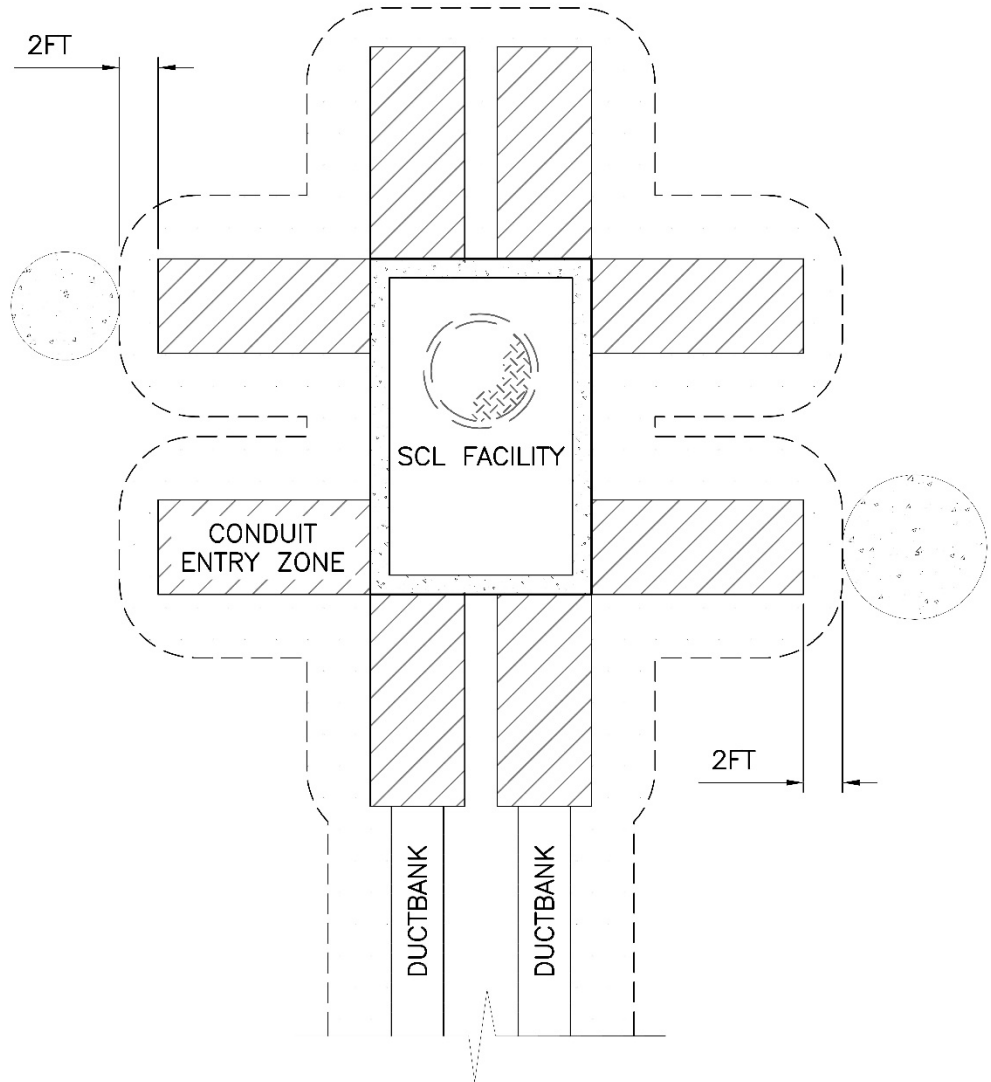

**Figure 4.6b. Vegetation Clearance, Elevation View**

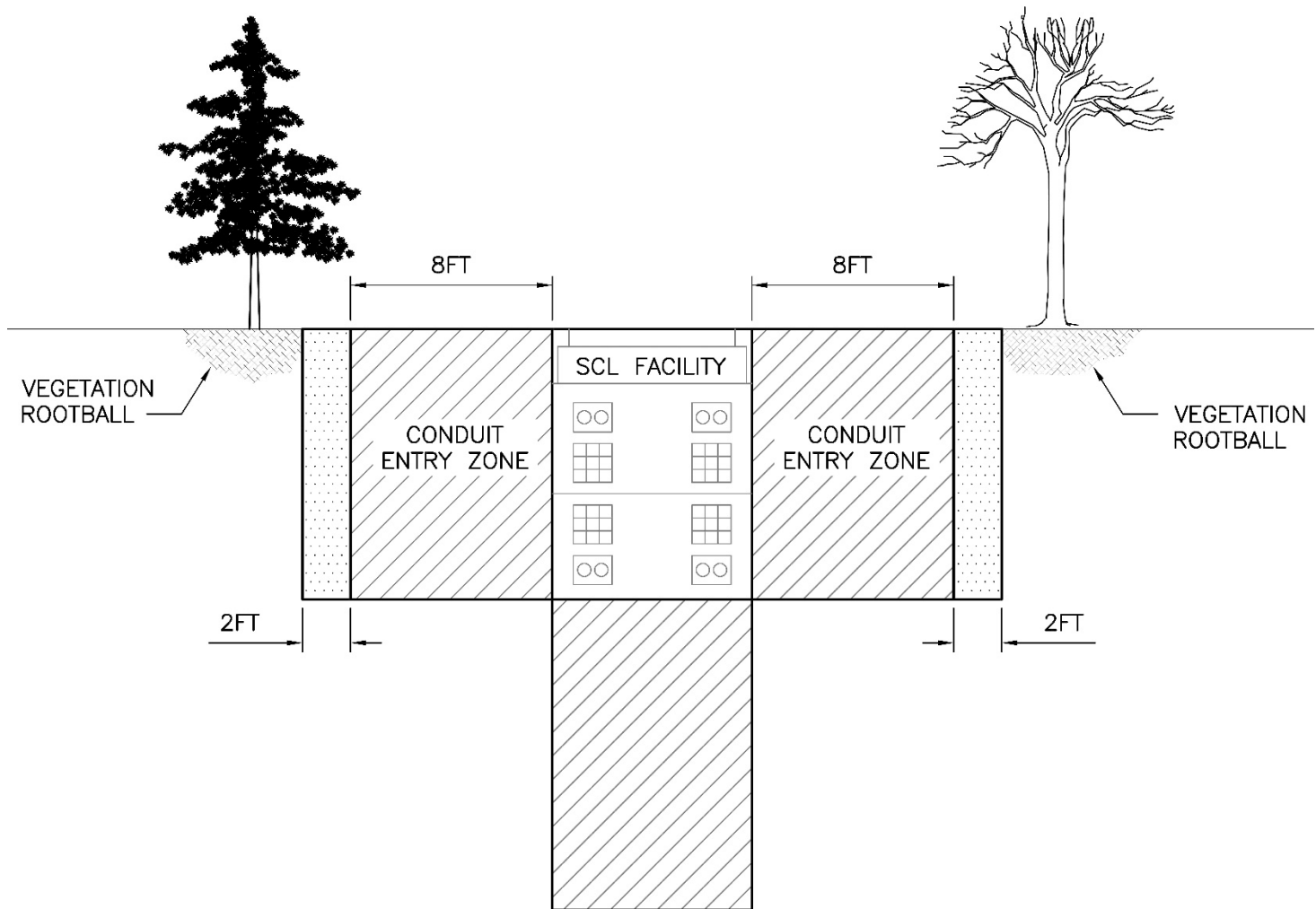

#### **4.7 Other Clearances for Vaults and Handholes in the Right-of-Way**

##### **4.7.1. Access and Working Space for SCL Underground Structures**

Facilities must be located to allow crane access for the installation and service of electrical equipment. The location of SCL facilities must allow permanent SCL vehicular (truck) access. SCL facilities must have a permanent, level, unobstructed, 8-ft wide working area adjacent to the facility for access to the facility and conduit entry zones.

##### **4.7.2. Other Horizontal Clearances**

See Table 4.7.2 for Clearances between SCL vaults, handholes, and conduit entry zones and other various non-SCL structures and objects.

For setback or clearance requirements from bioretention cells and rain gardens, see Seattle Rights of Way Improvement Manual Chapter 4, 4.17.5.

**Table 4.7.2. Horizontal Clearances between SCL Vaults, Handholes, and Vault Conduit Entries and Various Non-SCL Structures and Objects**

<b>Non-SCL Structures and Objects</b>	<b>Horizontal Clearance from SCL Vaults or Handholes (ft)</b>
Fire hydrants/water meters	3
Street curbing (to facility lid or hatch)	2
Building footings, building structures, and property lines	3
Metro bus poles and strain poles (overhead operations)	3
Concrete support columns	3
Concrete support column footings	3
Temporary construction shoring piles	1
Water maintenance holes	5
Catch basins and inlets	5
Water main thrust block	10

Note: For Looped Radial vaults intended to contain a transformer, the vault opening shall also be a minimum of 10 ft from all egress points (doorways, windows, stairways, and fire escapes).

**4.7.3. Vertical Clearances**

Overhead clearance ensures crane access to SCL vaults for lowering and raising equipment. The minimum overhead clearance above underground facilities (vaults and handholes) shall be 25 ft. This is the minimum height for all overhead structures and encumbrances such as roadway columns.

No installation is allowed directly above (at grade) or below SCL facilities without written SCL Engineering approval.

**5. SCL Conduits and Duct Banks in the Right-of-Way**

**5.1 Clearances for Conduits and Duct Banks up to 26 kV**

See Figures 5.1a and 5.1b and Table 5.1 for horizontal clearances.

See Figure 5.1c for vertical clearances.

**Figure 5.1a. Horizontal Clearances for Conduits and Duct Banks up to 26 kV, Non-Water Structures, Plan View**

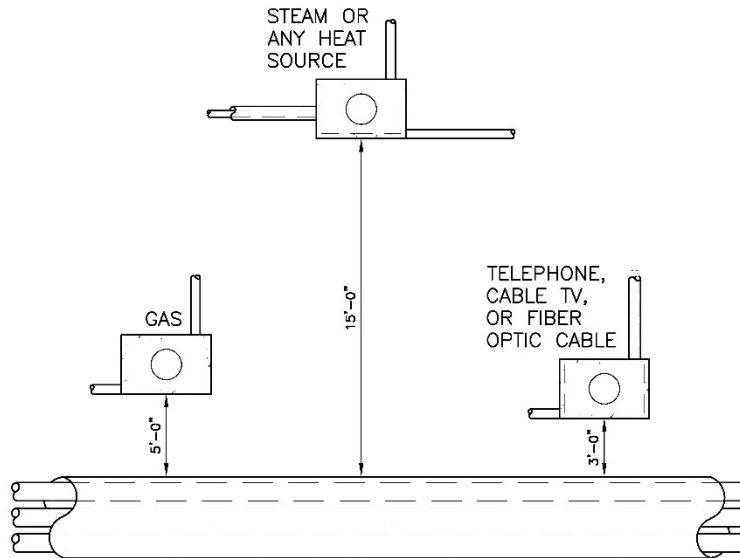

**Figure 5.1b. Horizontal Clearances for Conduits and Duct Banks up to 26 kV, Water Structures, Plan View**

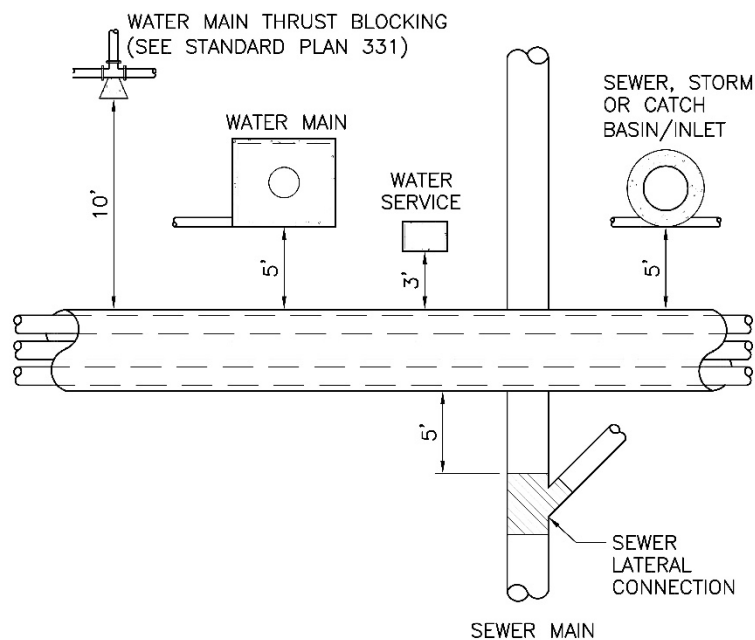

**Table 5.1. Other Horizontal Clearances for Conduits and Duct Banks up to 26 kV**

Non-SCL Structures and Objects	Horizontal Clearance from Conduits and Duct Banks Rated up to 26 kV (ft)
Fire hydrants/water meters	3
Street curbing (See SCL 1716.07 for streetlight conduits)	1
Building footings, building structures, and property lines	3
Metro bus poles and strain poles (overhead operations)	3
Concrete support columns	3
Concrete support column footings	3
Temporary construction shoring piles	1
Water maintenance holes	5
Catch basins and inlets	5

**Figure 5.1c. Vertical Clearances for Conduits and Duct Banks up to 26 kV, Elevation View**

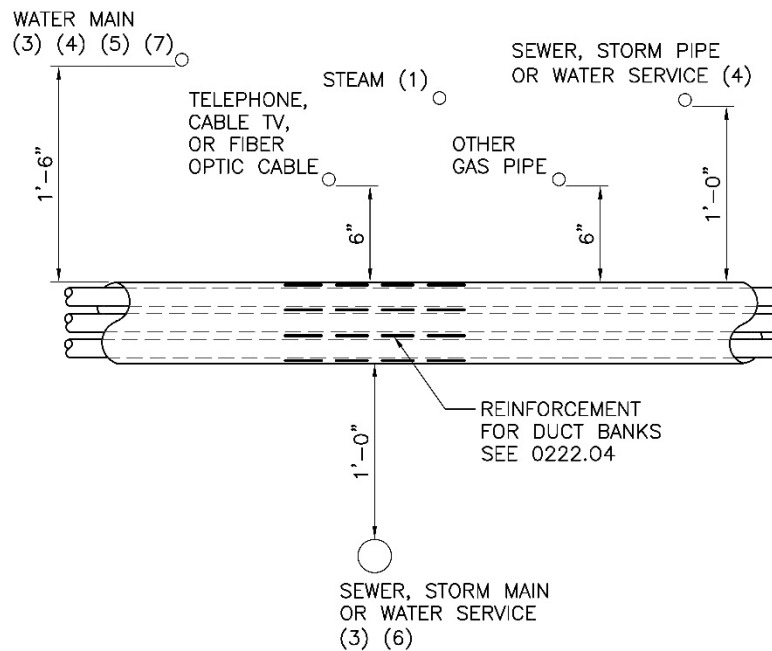

**Notes**

1. High pressure steam log or any heat source shall not cross SCL conduit or duct bank without SCL Engineering approval.
2. Vertical clearance applies to conduits crossing perpendicular to SCL conduits or duct banks. Non-SCL conduits are not allowed to be installed directly above or below parallel to SCL conduits or duct banks.
3. Crossing of sewer, storm, or water shall be perpendicular, except with written approval from SCL Engineering.
4. Backfill and bedding shall be installed as specified in Standard Plan 350 or 285, or per other AHJ.
5. Crossing under water, sewer, or storm laterals or mains requires support plan approved by the appropriate water AHJ and observation by that AHJ's construction management.
6. Conduit crossing over water, sewer, or storm laterals or mains shall be reinforced for a minimum of 5 ft to either side. See SCL 0222.04.
7. Water, sewer, storm AHJ shall be notified when any cast iron pipe is exposed.

## 5.2 Clearances for 115 or 230 kV Conduits and Duct Banks

If SCL conduit or duct bank contains 115 kV or 230 kV, the horizontal clearance between SCL facilities and non-SCL facilities shall be a minimum of 5 ft and the vertical clearance shall be a minimum of 1 ft.

For clearance between various other structures and SCL 115 or 230 kV conduits and duct banks, see Table 5.1.

**Table 5.2. Other Horizontal Clearances for 115 or 230 kV Conduits and Duct Banks**

<b>Non-SCL Structures and Objects</b>	<b>Horizontal Clearance from Conduits and Duct Banks Rated to 115 or 230 kV (ft)</b>
Fire hydrants/water meters	5
Street curbing	5
Building footings, building structures, and property lines	5
Metro bus poles and strain poles (overhead operations)	5
Concrete support columns	5
Concrete support column footings	5
Temporary construction shoring piles	1
Water maintenance holes	5
Catch basins and inlets	5

## 6. Shoring Clearances

During construction projects, shoring piles and shoring lagging shall maintain a clearance from SCL conduits, duct banks, handholes and vaults of at least 1 ft.

## 7. Clearances for Wood Poles

**Table 7. Horizontal Clearances Between SCL Wood Poles and Non-SCL Structures and Objects**

<b>Non-SCL Structures and Objects</b>	<b>Horizontal Clearance from SCL Wood Poles (ft)</b>
Below-grade utility lines (e.g., pipes and conduits)	4
Below-grade utility structures (e.g., handholes and vaults)	10
Curbs	3
At- and above-grade structures	5
At- and above-grade structures on the face/gain/equipment/brand side of the pole	10
Trees (measured from the center of the tree)	20



## 8. Clearances for SCL Facilities, Conduits, and Duct Banks on Private Property

Transformer vaults and pad clearances are outside the scope of this standard. See Standards 0724.50 and 0732.50.

All other clearances shall abide by the right-of-way requirements.

**Figure 8. Clearances on Private Property**

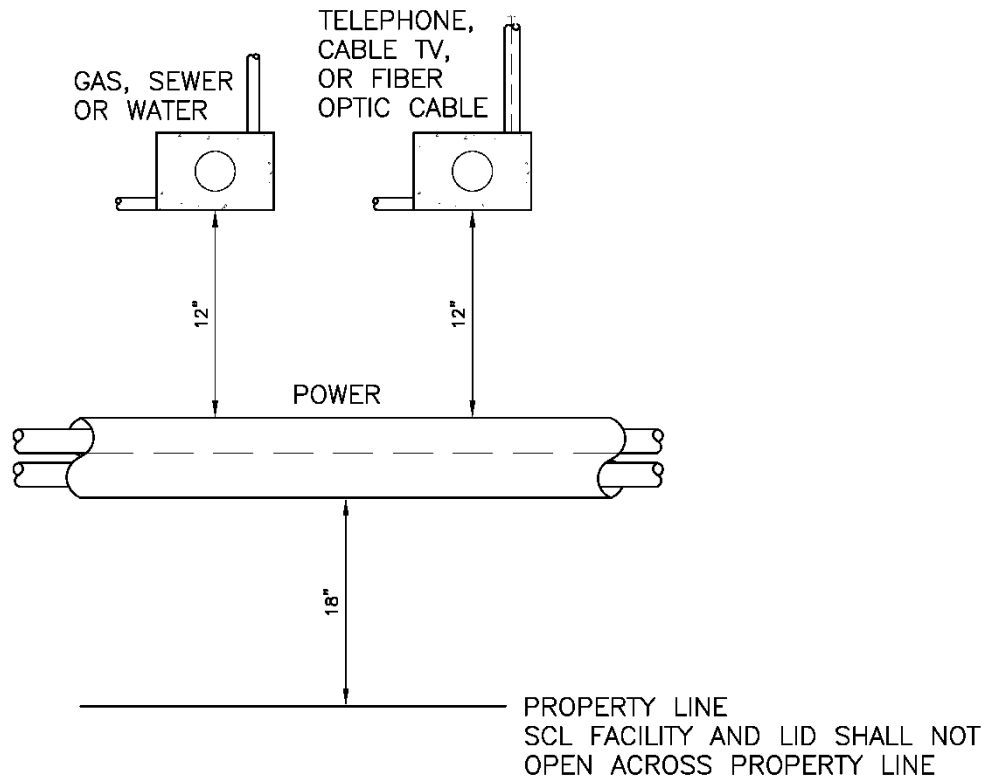

## 9. References

**SCL Construction Standard 0222.04**; "Duct Bank Reinforcement"

**SCL Construction Standard 0724.50**; "Customer Requirements for Padmount Transformer Services, Looped Radial System"

**SCL Construction Standard 0732.50**; "Customer Requirements for Below-Grade Transformer Service Vaults, Looped Radial System"

**SCL Construction Standard 1716.07**; "Streetlight Handhole and Conduit Requirements"

**SCL Construction Standard U2-14.2**; "Vault Installation"

**City of Seattle, Seattle Right-of-Way Improvement Manual**

**City of Seattle Standard Plans for Municipal Construction**

**City of Seattle Standard Specifications for Road, Bridge, and Municipal Construction**

## 10. Sources

**City of Seattle Standard Plan No. 030**; "Desired Locations for Utilities (Residential Street)"

**City of Seattle Standard Plan No. 285**; "Pipe Bedding Sewer/Storm"

**City of Seattle Standard Plan No. 331**; “Watermain Thrust Drain Blocking Horizontal Fittings”

**City of Seattle Standard Plan No. 350**; “Watermain Trench and Bedding”

**City of Seattle Standard Spec 1-07.17(2)**; “Utility Clearances”

**Hall, Alan**; SCL Engineer and subject matter expert for 0214.00

**NESC C2-2012, Part 3**: “Safety Rules for Underground Lines”

**Panomvana, Tanya**; SCL Standards Engineer and originator of 0214.00

**SCL Construction Guideline U2-10/NDK-50** (canceled); “Electrical Conduit and Facilities in Public Rights-of-Way”

**SCL Construction Guideline U9-6**; “577 Vault with Three Loadbreak Junction Boxes – Installation, Grounding and Connections”

**SCL Construction Standard 0232.05** (canceled); “Underground Residential Equipment Location of 577 Vaults and Secondary Handholes”