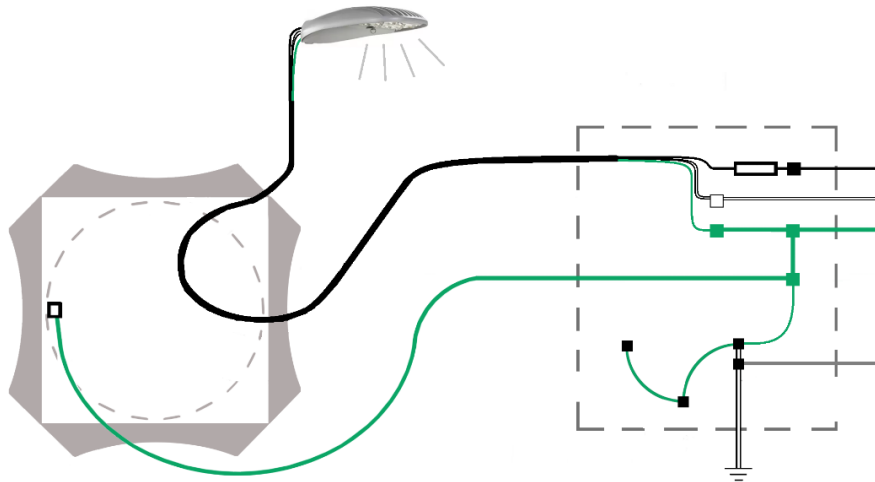

Underground Streetlight Systems**1. Scope**

This standard covers requirements for streetlight systems served by the Looped Radial and Network distribution systems.

Streetlights attached to wood poles or served exclusively by overhead conductors are outside the scope of this standard.

Pole and luminaire selection are outside the scope of this standard.

Streetlight systems that are not owned or maintained by SCL are outside the scope of this standard.

Note: Requirements for grounding and bonding of streetlight systems previously detailed in SCL 1710.50 (canceled) have been incorporated into this standard.

2. Application

This standard is intended for use by Seattle City Light (SCL) engineers, crews, and contractors responsible for designing and installing an underground streetlight system.

The following standards are closely related to this standard:

SCL 1714.10; "Circuit Tagging and Identification"

SCL 1714.30; "Streetlight Handhole Connections"

SCL 1716.07; "Streetlight Handhole and Conduit Requirements"

SCL 1730.00; "Streetlight Fusing Schedule, Individual"

Standard Coordinator
Brett Hanson

Standards Engineering Supervisor
Brett Hanson

Division Director
Bob Risch

3. Conflict

Where conflict exists between requirements, the following order of precedence shall apply:

1. SCL standards
2. City of Seattle Standard Specifications and Plans
3. Project-specific drawings
4. Other industry standards

4. Requirements, General

All metallic components shall be effectively bonded to ground.

When two or more streetlights are in the system, multiple circuits shall be used. Circuits shall alternate between streetlights to ensure that in the case of a one-circuit fault, every other streetlight would have power until repairs to the faulted circuit could be completed.

In the Looped Radial system, the streetlight system shall be supplied by an overhead transformer or service vault. The grounding system is established in the streetlight distribution handhole/manhole.

In the Network system, the streetlight system shall be supplied by a service vault. The grounding system is tied into the network vault.

Figure 4a shows the general components of a typical streetlight system and is provided as a general reference to language used throughout this standard.

Figure 4a. Components of a Typical Streetlight System

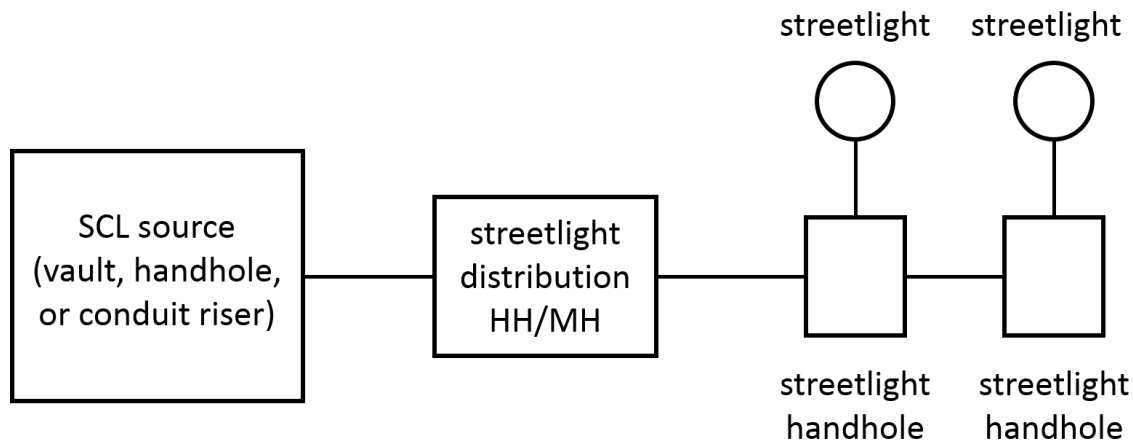
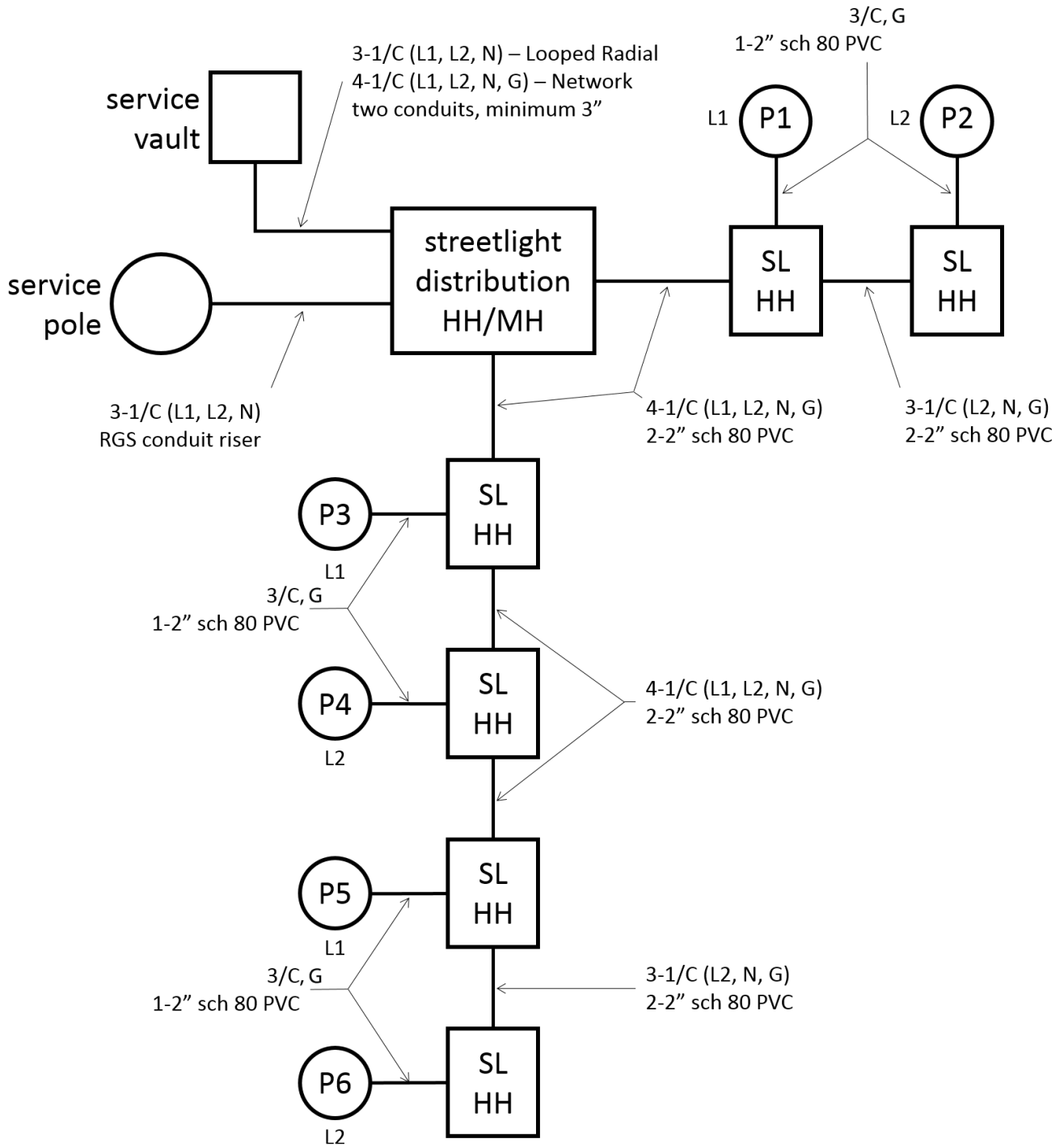

Figure 4b presents an example of a two-branch streetlight system supplied by an overhead transformer or service vault. This example is applicable for both the Looped Radial system and Network system with details outlined in the figure. Shown in the plan view are streetlights, the handholes that serve each streetlight, and the streetlight distribution handhole/manhole that connects the streetlight to the distribution system.

Figure 4b. Two Branch Streetlight System



5. Service Requirements

Service to underground streetlight systems is provided by overhead or underground sources based on the local ordinance and decision by SCL engineering.

5.1 Underground Service

SCL will install cable from the source to the distribution manhole/handhole.

Only SCL shall make the final service connection.

5.2 Overhead Service

For overhead service, conduit risers, riser extensions, and service terminations shall be installed per Figure 5.2 and meet the following requirements:

- Schedule 80 PVC conduit shall be used for riser extensions. The PVC conduit shall be installed above the first 10 ft of the steel riser, extending 6 inches below the LR bracket or 12 inches below the transformer.
- One unbraced bracket shall be used per 10-ft PVC conduit section. If brackets already exist, attach new riser conduits to the existing brackets, replacing with appropriate lengths if longer brackets are required.
- For existing conduit risers, the high voltage conduit shall be re-located closest to the pole. See SCL 0224.34 for more detail.
- Service wire between the SCL source and streetlight distribution handhole/manhole shall be, at a minimum, 3-#2 (L1, L2, N) and meet the requirements of SCL 6122.35.
- At the top of the service entrance cap, the installer shall coil 8 ft of wire for final service connection.
- An end cap shall be installed on all spare conduits.
- PVC cement shall be used when joining conduit.
- The minimum number of conduit risers shall be two.
- The minimum diameter of conduit risers shall be 2 inches.

Figure 5.2. Conduit Riser

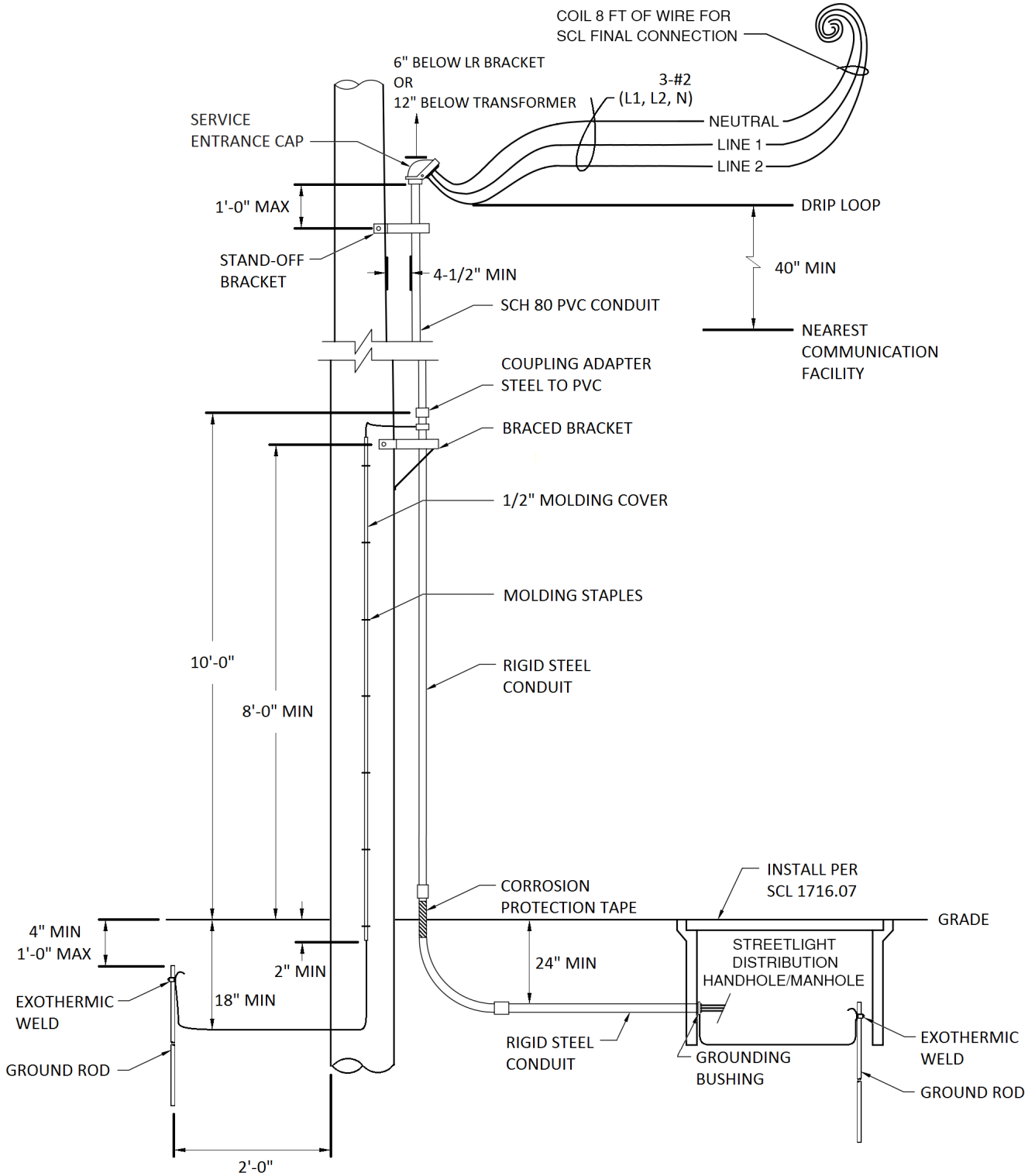

5.3 Looped Radial

Figure 5.3 shows the typical requirements of a streetlight service in the Looped Radial system.

Figure 5.3. Looped Radial Service Requirements

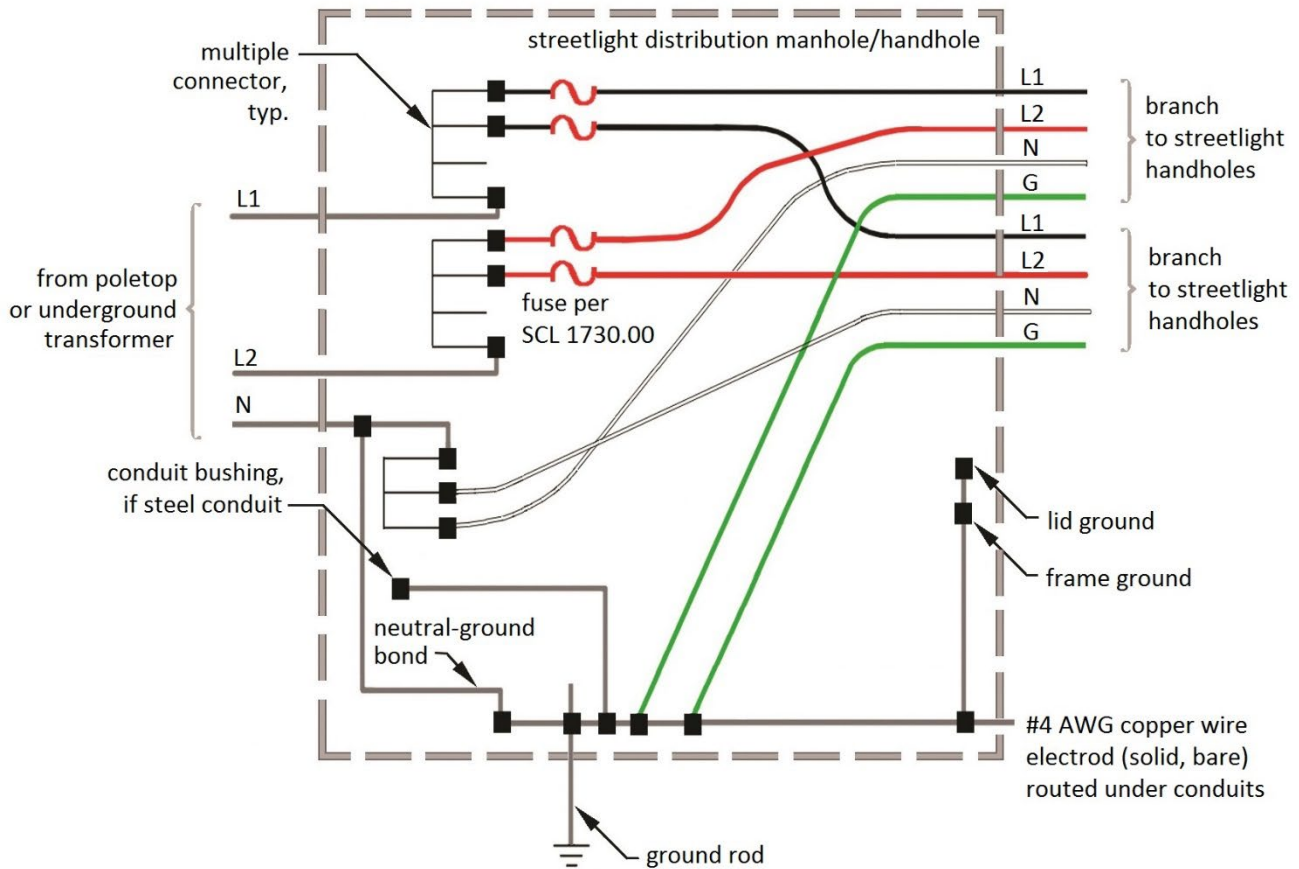

5.4 Network

Figure 5.4 shows the typical requirements of a streetlight service in the Network system.

Figure 5.4. Network Service Requirements

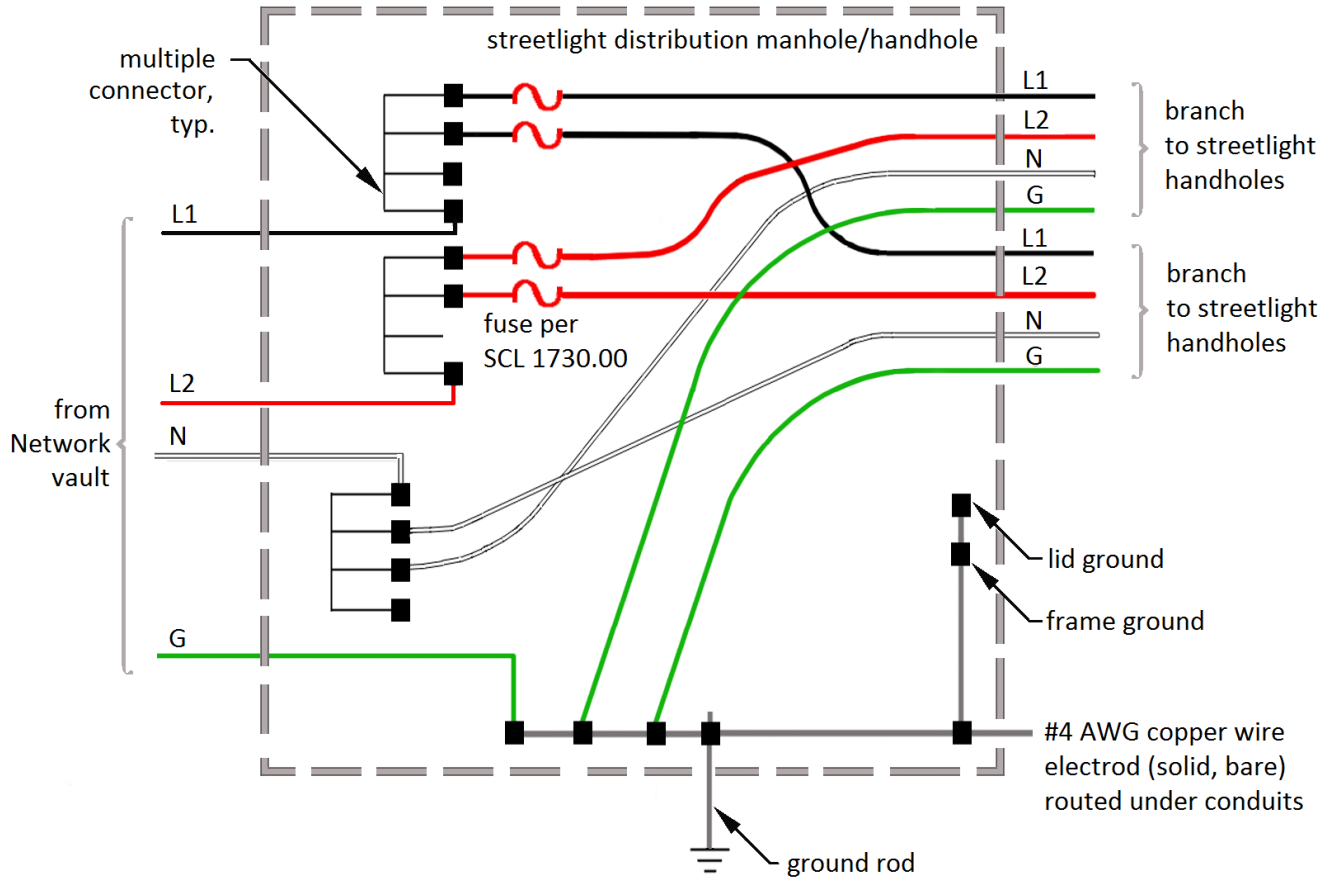

6. Grounding

The ground rod, or series of ground rods, shall be tested to ensure it has a resistance to ground of 25 ohms or less prior to connecting to the neutral or service.

A continuous #4 AWG copper wire electrode (solid, bare) shall be connected to each ground rod lead and routed under the handhole conduits to help achieve the 25-ohm requirement.

Connections to grounding electrodes shall be exothermic welds that are listed for direct burial use.

Ground rods shall be located in the corner of the handhole and shall not interfere with conduits and wires. See Figure 6.

Figure 6. Ground Rod Location, Plan View

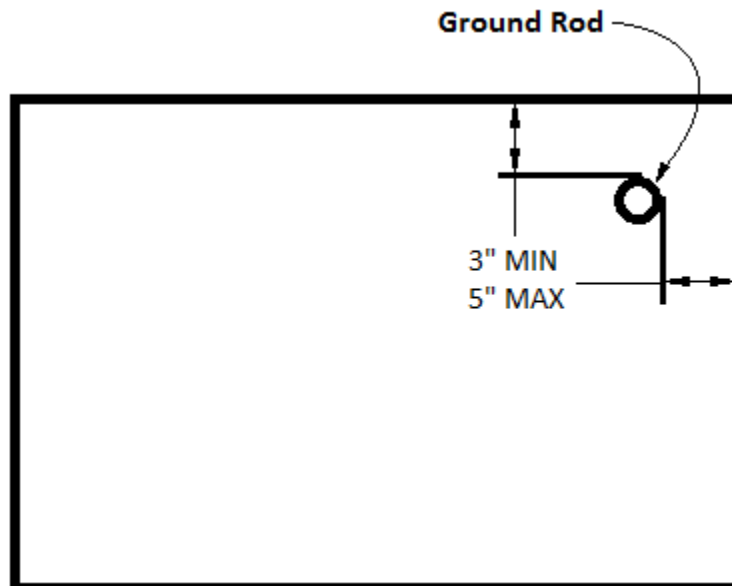

See Figure 7 for grounding requirements for streetlight pole handholes and streetlight handholes.

Grounding requirements in the streetlight distribution handhole/manhole differ between streetlight systems fed by the Looped Radial system and the Network system. See sections 5.3 and 5.4 for details.

6.1 Grounding in the Looped Radial System

Grounding for streetlight systems fed by the Looped Radial system is established in the streetlight distribution handhole/manhole and does not share the same ground connection as the source.

The green grounding conductor is bonded to the neutral in this handhole. This is the only point in the streetlight system where the neutral and ground conductors are bonded together. See Figure 5.3.





6.2 Grounding in the Network System

Grounding for streetlight systems fed by the Network system is shared with the Network system.

The green grounding conductor is bonded to the neutral within the Network vault. There shall not be neutral to ground connections made in the streetlight distribution handhole. See Figure 5.4.

7. Wiring

For 120/240V or 120/208V systems, all conductors shall have a continuous outer finish to match the following color code:

 Black	L1
 Red	L2 (if more than one)
 Blue	L3 (for 208V, or festoon)
 White	Neutral
 Green	Ground

For 277/480V systems, all conductors shall have a continuous outer finish to match the following color code:

 Brown	L1
 Orange	L2
 Yellow	L3
 Gray	Neutral
 Green with yellow stripes	Ground

The pole and bracket cable shall be jacketed, #12 AWG, three-conductor per SCL 6404.45.

Conductors running between handholes are specified by the engineer based on current draw, length of cable run, etc. Generally, the minimum size for most runs is #6 AWG.

Connections in handholes shall be constructed per SCL 1714.30.

Multi-tap underground connectors, if used, shall meet the requirements of SCL 6780.46. Further, such connectors shall only be used for the following applications:

- Streetlight distribution manholes or handholes
- Co-located manholes or handholes feeding small wireless facilities. See SCL 0095.60.

Circuit tagging and identification shall conform to SCL 1714.10.

Figure 7 shows typical wiring (including grounding) requirements for streetlight pole handhole and streetlight handholes.

Figure 7. Streetlight Pole Handhole and Streetlight Handhole Requirements

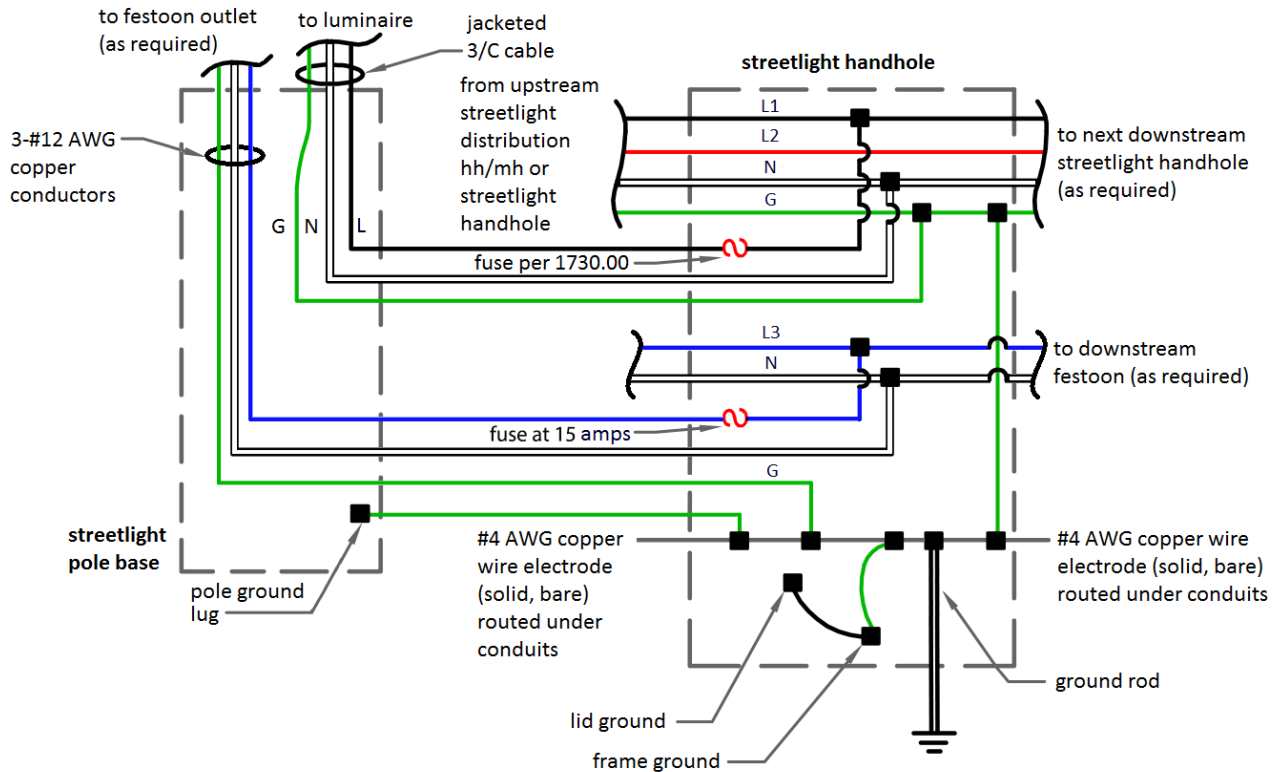

7.1 Coiling and Racking

In type 2 and 3 handholes, wire shall be neatly coiled.

In larger enclosures, wire shall be neatly racked using cable racks and hooks. Cable racks and hooks shall not interfere with conduit penetrations.

Cable racks shall be 24 inches in length and installed centered on the wall per table 7.1.

Table 7.1 Cable Rack Installation

Handhole	Total # of Racks	Short Wall, # of Racks	Long Wall, # of Racks
233	6	1	2
444	8	2	2
577	10	2	3

7.2 Festoon Outlet

Where festoon outlets are installed on poles, a separate circuit shall be provided from the source. The festoon circuit shall be constructed in the same manner as the lighting circuits. See Figure 7.

Festoon outlets shall be constructed per City of Seattle Standard Plan 563b.

Festoon receptacles shall comply with SCL 7330.55 and meet the following requirements:

- 20 amperes
- 125 Vac
- GFCI
- NEMA configuration 5-20R
- Rated "Hospital Grade" under UL 498

Festoon circuits shall be fused at 15 amps in the adjacent streetlight handhole per 1730.00 and labeled per SCL 1714.10.

8. Fusing

See SCL 1730.00 for individual streetlight fusing requirements. This fuse is located in the streetlight handhole.

The streetlight system fuse, located in the streetlight distribution handhole/manhole, is specified by the engineer.

9. Handholes and Conduits

See SCL 1716.07 for detailed requirements for streetlight handholes and conduits.

A streetlight handhole shall be provided for each streetlight and be placed downstream and adjacent to the streetlight pole and curb. See Figure 9.

Figure 9. Streetlight Handhole

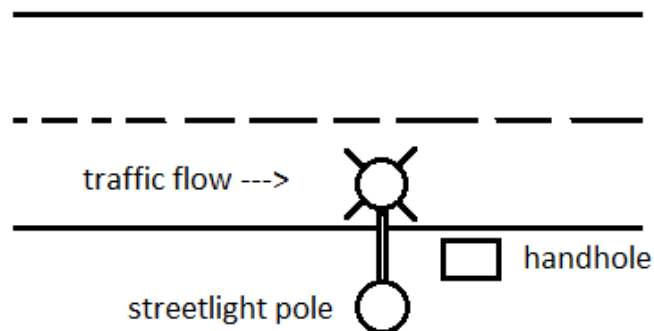

10. Inspection Points

Inspection points shall be adhered to for all installation projects. Inspection points are put in place to ensure conformity to SCL requirements. Failure of inspection request may result in additional requirements. Contact Streetlight Engineering for further details.

An inspection by an SCL Electrical Reviewer is required for the following:

- Conduits and #4 AWG ground wire, before cover
- Handholes, before cover
- Conduit mandrel, before wire installation
- Grounding and bonding inspection and test
- Handhole and fixture wiring
- Foundations, poles, and fixtures

11. Material Lists

11.1 Wiring

Description	Stock No.
Wire	See SCL 6122.35
Service wire, #2 AWG	See SCL 6122.35
Pole and bracket cable, 1-3/C #12 AWG	014072
Multi-tap connector, 600 V	
4 position, #12 AWG to 350 kcmil	013661
6 position, #12 AWG to 350 kcmi	013662
Fuse, fast-acting, rejection type, 600 V	
3 A	013509
5 A	013510
10 A	013511
15 A	013512
Fuse holder, 600 V, rejection-type	
#12 AWG–#8 AWG to #6 AWG	013518
#6 AWG to #6 AWG	013519
#6 AWG to #2 AWG	013520
#2 AWG to #2 AWG	013521
Insulating boot	682360

11.2 Grounding

Description	Stock No.
Ground rod, 5/8" x 8'	564238
Ground rod stud, 5/8"	564604
Ground rod coupling, 5/8"	564074
Wire, copper-clad steel	012702
Bushing, grounding, insulated, 2"	731531
Wire, solid, bare, #4 AWG	610208
Wire staples, 1-1/2" x 14"	583180
Plastic molding, 1/2" x 8'	582060
Molding staples, 2" x 1/2"	583200

11.3 Conduit Riser and Extension

Description	Stock No.
Service entrance cap, PVC, 2"	013575
Conduit, SCH 80 PVC, 2"	738741
Strap, strut pipe/conduit, 2"	689764
Bolt, lag, 1/2" x 4"	785261
Cement, PVC	726680
Plug, PVC, 2"	734938
Conduit adapter, PVC to steel, 2"	734544
Conduit, rigid steel, 2"	734741
Tape, pipe wrap, PVC, 2" x 10 mil (roll)	736730
Elbow, rigid steel, 36" radius	
2"	734820
3"	734822

11.4 Handhole

Description	Stock No.
Handhole with cover, "SL"	
17" x 28" x 12"	013178
24" x 36" x 12"	013182
24" x 36" x 36"	013179
42" x 42" x 42"	See SCL 7203.26

12. References

Plan 563b, City of Seattle Standard Plans for Municipal Construction

SCL Construction Standard 0095.60; "Co-Located Small Wireless Facilities on Metal Streetlight Poles"

SCL Construction Standard 0224.34; "Steel Conduit Risers"

SCL Construction Standard 1714.10; "Streetlight Circuit Tagging and Identification System"

SCL Construction Standard 1716.07; "Streetlight Handhole and Conduit Requirements"

SCL Construction Standard 1730.00; "Streetlight Fusing Schedule, Individual"

SCL Material Standard 6122.35; "Wire, 600 V, Single-Conductor, Thermoplastic-Insulated"

SCL Material Standard 6404.45; "Cable, Streetlight, Pole and Bracket, 3/C, 600 V"

SCL Material Standard 6780.46; "Connectors, Underground, Multi-Tap, 600 Volt"

SCL Material Standard 7203.26; "444 Electric Vault, Primary Service"

SCL Material Standard 7330.55; "Receptacles (Outlets)"

SCL Work Practice 1714.30; "Streetlight Handhole Connections"

UL 498; Standard for Attachment Plugs and Receptacles"

13. Sources

Borek, Tom; SCL Streetlight Engineer and subject matter expert for 1714.50

Chao, Yaochiem; SCL Standards Engineer, subject matter expert, and originator of 1714.50

Edwards, Tommy; SCL Electrical Reviewer and subject matter expert for 1714.50

Hanson, Brett; SCL Standards Engineering Supervisor and subject matter expert for 1714.50

Li, Jesse; SCL Streetlight Engineer and subject matter expert for 1714.50

SCL Construction Standard 1710.50 (canceled); "Streetlight System Grounding and Bonding"