



**Seattle City Light**

**STANDARDS FOR  
ELECTRIC SERVICE  
2021 Edition**



Seattle City Light

# Standards for Electric Service 2021 Edition

Welcome to the fourth edition of the Seattle City Light Standards for Electric Service. This is a collection of all standards referenced in the Requirements for Electric Service Connection (RESC) and in each version of Service Construction Letter Attachment C.

The Standards for Electric Service is designed for use by Energy Delivery Engineering staff as well as customers, developers and contractors. The standards in this collection apply whenever any public or private construction is performed within City Light Service Territory.

All standards included in this edition are effective as of January 2021.

A handwritten signature in black ink, appearing to read "Mike Haynes", with a horizontal line underneath the name.

Mike Haynes, Chief Operating Officer

**Seattle City Light  
Standards for Electric Service 2021 Edition**

Published by the Seattle City Light Standards Org  
Seattle, Washington  
January 2021

Prepared by Laura Vanderpool  
Cover photo credit: John Shipek, Standards

Printed on 100% recycled content paper



## Preface

Significant Revisions and Additions Since Last Publication.....	page v
Service Construction Letter Attachment C Cross-Reference.....	page vii

## Construction Standards

0130.30	Secondary Service Drops .....	1
0214.00	Clearances Between SCL UG Structures and Other Utility Structures in the Public ROW .....	11
0221.01	Customer Requirements for Trenching in the Right-of-Way .....	28
0222.02	Requirements for Primary Conduit and Duct Bank Installation .....	30
0223.03	Customer Requirements for Horizontal Directional Drilling.....	40
0223.33	Cast-in-Place Concrete Vault Collars.....	43
0224.01	Customer Requirements for Underground Secondary Service, Looped Radial System .....	47
0224.07	Requirements for Secondary Conduit Installation.....	51
0224.34	Steel Conduit Risers .....	57
0226.06	Installation of Fluidized Thermal Backfill .....	65
0230.03	Requirements for Pad-Mounted Termination Enclosure Installations .....	69
0231.01	Secondary Handhole Installation and Grounding.....	74
0231.03	Cast-in-Place Risers .....	84
0257.06	Ceiling Channel for In-Building Vaults .....	90
0461.10	Grounding Electrodes for Handholes and Vaults .....	92
0468.90	Exothermic Connection System .....	97
0473.50	Looped Radial and Network Service Entrance Cables in Conduit .....	101
0474.08	Looped Radial and Network Dry Vault Service Entrance Bus Duct.....	103
0674.06	In-Building Vault Lighting and Receptacle Requirements, Looped Radial System .....	109
0724.50	Customer Requirements, Pad-Mounted Transformers, Looped Radial System.....	111
0732.50	Customer Requirements, Below-Grade Transformer Vaults, Looped Radial System.....	122
0735.50	Oil Containment Systems .....	127
0751.00	Customer Requirements, In-Building Transformer Vaults .....	130
0751.49	In-Building Transformer Vault Doors.....	142
0751.60	Concurrent Customer Requirements, In-Building Transformer Vaults .....	147
0751.77	In-Building Vault Equipment Clearances .....	157
1553.03	Meter Base and Socket Configurations.....	168
1561.05	Customer Requirements for Underground Residential Service Entrance, Single or Dual Meters.....	178
1561.07	Customer Requirements for Underground Secondary Service Termination Facilities.....	188
1561.09	Requirements for Underground Services in the Public Right-of-Way.....	196
1611.05	Excavation in the Vicinity of Underground Transmission Lines .....	199
D2-3	Clearances from Structures and Ground .....	203
NCI-62	Pulling Iron Installation for In-Building Vaults, Network System.....	211
NVH-80	Network Area Requirements for Panel or Cast-in-Place Vaults .....	214
U2-11.40/NDK-40	Mandreling and Cleaning of Ducts and Conduits .....	219
U2-14.2	Vault Installation .....	220
U2-15.1	Installation of Ring Type Vaults .....	223
U2-22	Pre-Cast Panel Vault Installation, General Non-Network Area.....	227

*Continued on the next page*



## Material Standards

6103.90	Wire, Copper, Bare, Soft-Drawn .....	230
6762.25	Ground Rods, Copper-Covered, Sectional.....	232
6836.2	Limiter, 600 V, Copper Cable to Bus Bar .....	233
6836.3	Limiter, 600 V, Copper Cable to Copper Cable .....	234
6836.6	Limiter, 600 V, Aluminum Cable to Aluminum Cable .....	235
6836.50	Limiter, 600 V, Aluminum Cable to Bus Bar .....	236
7005.05	Tape, Detectable, Underground.....	237
7015.05	Schedule 40 PVC Conduit and Fittings .....	239
7015.80	Conduit Spacers for PVC and FG Conduit .....	248
7050.05	Zinc-Coated Steel Conduit and Fittings .....	249
7050.09	Conduit Fitting, Cable Protector .....	253
7055.09	DB120, PVC Conduit Fittings .....	254
7150.00	Fluidized Thermal Backfill .....	255
7203.01	Precast Reinforced Concrete Handholes, General Requirements.....	259
7203.04	3030 Handhole, Precast, Secondary .....	266
7203.08	231 and 233 Handholes, Precast, Secondary and Streetlight, Detailed .....	270
7203.10	Type 1 and Type 2 Open Bottom Handhole, Precast, Secondary .....	277
7203.12	Handhole, Secondary, Composite Fiberglass, Polymer Concrete .....	282
7203.21	Precast Reinforced Concrete Structures, General .....	287
7203.26	444 Enclosures, Precast.....	296
7203.31	504 Electric Vault, Primary Service .....	302
7203.36	507 Electric Vault, Primary Service .....	307
7203.38	575 Electric Vault, Primary Service .....	312
7203.41	577 Electric Vault, Primary Service .....	316
7203.46	712 Electric Vault, Primary Service .....	322
7203.51	814 Electric Vault, Primary Service .....	335
7203.66	687 Electric Vault, Primary Service .....	362
7203.76	Precast Reinforced Concrete Transformer Pads .....	369
7645.30	Pull Tape, Polyester .....	373
7645.40	Mandrels, Proofing .....	376
7651.25	Customer Requirements for Vault Signage .....	379

NEWLY-ADDED STANDARDS		
Std No.	Title	Description
0221.01	Customer Requirements for Trenching in the Right-of-Way	New construction standard created to capture requirements for trenching in the right-of-way that used to be in DPP 500 P III-424.
1611.05	Excavation in the Vicinity of Underground Transmission Lines	This construction standard describes the requirements for excavation in the vicinity of underground transmission lines within the SCL service territory.
7005.05	Tape, Detectable, Underground, Marking	This material standard specifies marking tape used for detecting, locating, identifying, and protecting buried electric lines installed in trenches or conduits.
7645.30	Pull Tape, Polyester	This material standard specifies the pull tape used to initiate cable pulling in underground conduit systems.

REVISED STANDARDS		
Std No.	Title	Description
0214.00	Clearances between SCL Underground Structures and Other Structures	Clarified clearances to water and other utilities.
0222.02	Requirements for Primary Conduit and Duct Bank Installation	Clarified backfill and duct bank construction and inspection requirements.
0223.03	Customer Requirements for Horizontal Directional Drilling	Added note for larger conduits.
0223.33	Cast-in-Place Concrete Vault Collars	Clarified collar requirements for vaults with risers.
0224.01	Customer Requirements for Underground Secondary Service, Looped Radial System	Revised Figure 5 conduit references.
0224.07	Requirements for Secondary Conduit Installation	Revised Section 4 Network requirements and updated figures. Updated conduit, spacer, and inspection requirements.
0224.34	Steel Conduit Risers	Revised to provide CDF backfill requirements and ground clamp requirement with references notes to their corresponding SCL standards.  Revised to include conduit tag details and requirements.
0226.06	Installation of Fluidized Thermal Backfill	Simplified references to City of Seattle standards.
0231.01	Secondary Handhole Installation and Grounding	Updated Section 4 figures and requirements.
0257.06	Ceiling Channel for In-Building Vaults	Clarified reference to customer service bus.
0461.10	Grounding Electrodes for Handholes and Vaults	Updated Section 5 components. Clarified Section 6 table and sealing details.
0724.50	Customer Requirements for Padmount Transformer Services, Looped Radial System	Rearranged Table 5 rows for clarity.
0732.50	Customer Requirements for Below-Grade Transformer Service Vaults, Looped Radial System	Clarified clearance to structures.
0735.50	Oil Containment Systems	Updated product names.
0751.00	Customer Requirements, In-Building Transformer Vaults, Network and LR Systems	Revised keybox mounting. Updated concrete finishes and pulling irons, exhaust, and drainage.
0751.60	Concurrent Customer Requirements, In-Building Transformer Vaults	Clarified points of inspection and customer service connection.
0751.77	In-Building Vault Equipment Clearances	Revised clearances in Figures 3.7c and 3.7d.
1561.05	Customer Requirements for Underground Residential Service Entrances, Single or Dual Meters	Revised to add minimum clearance requirements for hose bib and harmonize Section 4.3 with the RESC. Figure 4.6.2 has also been updated to show the correct figure for "Pedestal-Mount Meters, 320A."

*Continued on the next page*

1561.07	Customer Requirements for Underground Secondary Service Termination Facilities	Clarified conduits entering the building and Figure 5.
NVH-80	Network Area Requirements for Panel or Cast-in-Place Vaults	Added reference for frames and covers.
U2-11.40/NDK-40	Mandreling and Cleaning of Ducts and Conduits	Clarified slack pull tape lengths
U2-14.2	Vault Installation	Updated cover requirements and references.
U2-15.1	Installation of Ring-Type Vaults	Updated cover requirements and references.
U2-22	Precast Panel Vault Installation, General, Non-Network Area	Updated cover requirements and references.
7015.05	Schedule 40 PVC Conduit and Fittings	Revised to allow for bell-straight chamfered end or straight-straight chamfered ends for schedule 40 PVC 5-inch conduit.
7150.00	Fluidized Thermal Backfill	Updated Section 7 regarding approved suppliers and mix design and their updated corresponding expiration dates.
7203.01	Precast Reinforced Concrete Handholes, General Requirements	Updated the metal hatch label requirement. Changed "SL/TC" to "SL/SDOT" for Streetlight and Seattle Department of Transportation (Traffic Control) - Joint Use to correlate with the City of Seattle 2020 Standard Plans No. 550a. Replaced handhole label "Electric" with "SCL" for secondary service handholes.
7203.04	3030 Handhole, Precast, Secondary	Replaced handhole label "Electric" with "SCL" for secondary service handholes.
7203.08	231 and 233 Handholes, Precast, Secondary and Streetlight, Detailed	Replaced handhole label "Electric" with "SCL" for secondary service handholes.
7203.10	Type 1 and Type 2 Open Bottom Handhole, Precast, Secondary and Streetlight	Replaced handhole label "Electric" with "SCL" for secondary service handholes. Label plates may be used in place of letters directly welded on the handhole covers.
7203.21	Precast Reinforced Concrete Structures, General	Updated ladder requirements in accordance with SCL Drawing D-28304, "Retractable Ladder, Vault and Manhole Access.," Rev 5.
7203.26	444 Enclosures, Precast	Replaced handhole label "Electric" with "SCL" for secondary service handholes.
7203.46	712 Electric Vault, Primary Service	In the application statement, changed the transformer size from "up to 501 kVA (3-167 kVA)" to "up to 300 kVA (3-100 kVA)."

**Service Construction Letter Attachment C**

<b>Standard No.</b>	<b>Secondary Underground</b>	<b>Multi-Lot Residential Development</b>	<b>Transformer Pad</b>	<b>Fenced Transformer Enclosure</b>	<b>Precast Below-Grade Vault</b>	<b>In-Building Vault</b>	<b>Network</b>
0214.00	x	x	x	x	x	x	x
0221.01	x	x	x	x	x	x	x
0222.02		x	x	x	x	x	x
0223.03	x						
0223.33	x	x	x	x	x	x	x
0224.01	x	x					
0224.07	x	x	x		x		x
0224.34	x	x	x	x	x	x	
0226.06		x	x	x	x	x	
0230.03			x		x		
0231.01	x	x	x				
0231.03		x			x		
0257.06						x	x
0461.10	x	x	x	x	x	x	
0468.90	x	x	x	x	x	x	
0473.50			x	x	x	x	x
0474.08						x	x
0674.06						x	
0724.50		x	x				
0732.50		x			x		
0735.50			x	x			
0751.00						x	x
0751.49						x	x
0751.60						x	x
0751.77						x	x
1553.03	x	x	x	x	x	x	
1561.05	x	x					
1561.07	x	x					
1561.09	x						
1611.05	x	x	x	x	x	x	x
D2-3	x	x	x	x	x	x	
NCI-62						x	x
NVH-80							x
U2-11.40/NDK-40	x	x	x	x	x	x	x
U2-14.2	x	x			x	x	
U2-15.1	x	x			x		
U2-22							x

*Continued on the next page*



Service Construction Letter Attachment C							
Standard No.	Secondary Underground	Multi-Lot Residential Development	Transformer Pad	Fenced Transformer Enclosure	Precast Below-Grade Vault	In-Building Vault	Network
6103.90	x	x	x	x	x	x	
6762.25	x	x	x	x	x	x	
6836.2							x
6836.3							x
6836.6							x
6836.50							x
7005.05	x	x	x	x	x	x	x
7015.05	x	x	x	x	x	x	x
7015.80		x	x	x	x	x	x
7050.05	x	x	x	x	x	x	x
7050.09	x	x					
7055.09	x	x	x	x	x	x	
7150.00		x	x	x	x	x	
7203.01	x	x	x				
7203.04	x	x	x				
7203.08	x	x	x				
7203.10	x	x					
7203.12	x	x					
7203.21	x	x	x	x	x	x	x
7203.26	x	x	x				
7203.31		x	x				
7203.36		x	x				
7203.38		x	x	x	x	x	
7203.41		x	x	x	x	x	
7203.46		x			x		
7203.51		x			x		
7203.66		x	x		x		
7203.76			x				
7645.30	x	x	x	x	x	x	x
7645.40	x	x	x	x	x	x	x
7651.25					x	x	

## Secondary Service Drops

### 1. Scope

This standard covers the information necessary to install overhead secondary service drop conductors (“service drops”) to buildings in the Seattle City Light (SCL) Looped Radial Distribution System.

### 2. Application

This standard provides direction to SCL engineers, crews, and approved contractors for the installation of service drops.

For installing secondary spans, see SCL 0130.10

For installing bridles for secondary service, see SCL 0130.20.

For LR bracket installation, see SCL 0100.11.

### 3. Requirements

#### 3.1 Clearances

##### 3.1.1. Vertical Clearances Between Service Conductor and Communication Cable

Vertical clearances between the service drop and communication drop, anywhere in the span to the building attachments, shall be per Table 3.1.1.

**Table 3.1.1. Vertical Clearance between Service Conductor and Communication Cable**

Location	Clearance, Minimum (in)
At pole attachments	40
In span or at building (including drip loop)	12

##### 3.1.2. Vertical Clearances in the Span

The point of attachment at the pole or service entrance shall be high enough above the ground to meet the required minimum vertical clearances along service drop spans to ground, roadways, alleys, driveways, porches, balconies, windows, doors, or roofs as shown in Table 3.1.2. and Figure 3.1.2.

Standards Coordinator  
Ponet Neuansourinh

Standards Supervisor  
John Shipek

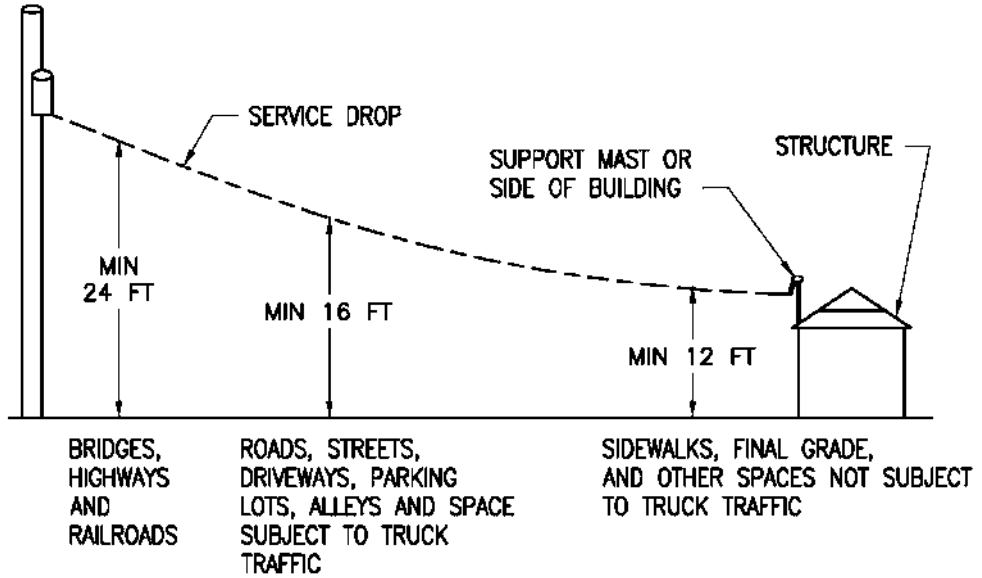
Unit Director  
Andrew Strong



**Table 3.1.2. Vertical Clearances in the Span**

Location	Clearance, minimum (ft)
Above bridges, highways, and railroads	24
Above roads, streets, driveways, parking lots, alleys, and spaces subject to truck traffic	16
Above sidewalks, final grade, and space not subject to truck traffic	12

**Figure 3.1.2. Vertical Clearances in the Spans**



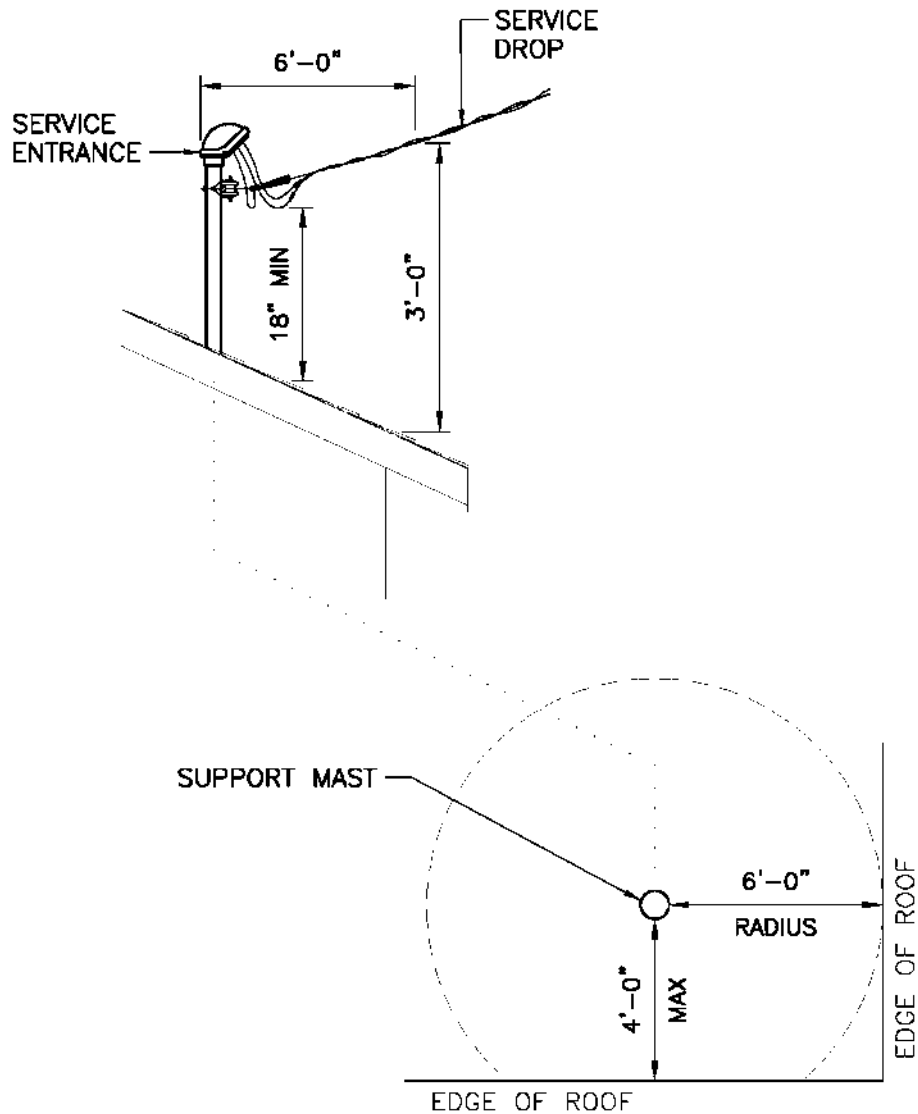
**3.1.3. Clearances for Service Drop Terminations at the Support Mast on a Roof**

Minimum required clearances for service drop terminations at the support mast on a roof are as shown in Table 3.1.3. and Figure 3.1.3.

**Table 3.1.3. Clearances of Service Drops Terminating at the Support Mast on a Roof**

Location	Clearance, minimum
Between the roof and the drip loop	18 in
Between the top of the weatherhead and the rigid clevis (strike)	8 in
Above the roof outside of a 6-ft radius from the service mast	3 ft

**Figure 3.1.3. Clearances of Service Drops Terminating on a Support Mast, Profile View (left) and Plan View (right)**





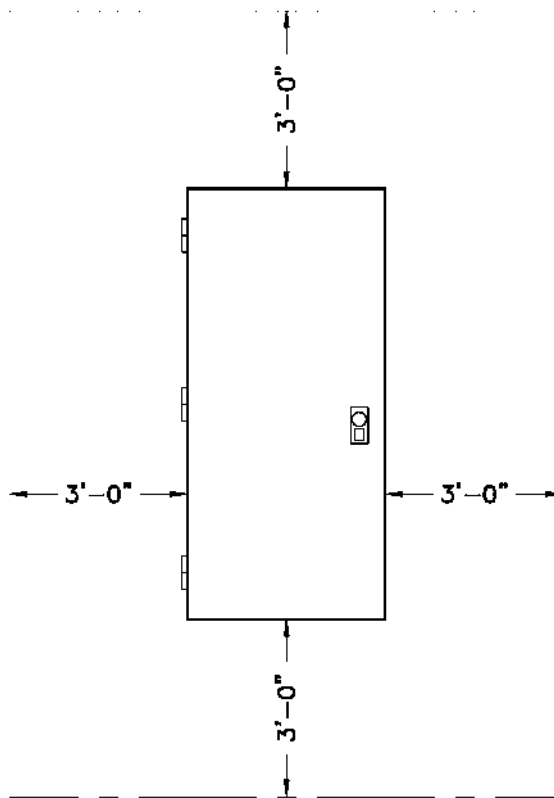
**3.1.4. Clearances for Service Drops Terminating on the Side of a Building**

Minimum required clearances for service drops terminating on the side of a building shall be as shown in Table 3.1.4 and figures 3.1.4a–c.

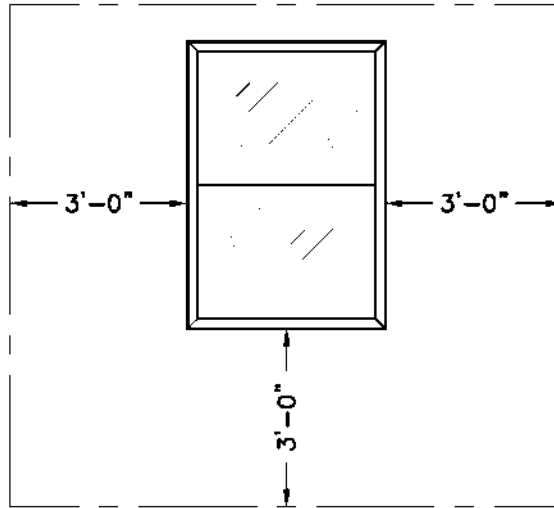
**Table 3.1.4. Clearances of Service Drops Terminating on the Side of a Building**

Location	Clearance, minimum
In all directions when not attached to, or passing by, structures up to the strike point on a building	5 ft
Below, and to the sides of, balconies, decks, or similar locations	3 ft
In all directions between windows and doors	3 ft
Exceptions:	
○ Where the service drop is above the top level of the window	
○ Where a window is designed not to open	
Above base of balconies, decks, or similar locations	11 ft
Horizontally from the building wall to which the service drop is attached	1 in

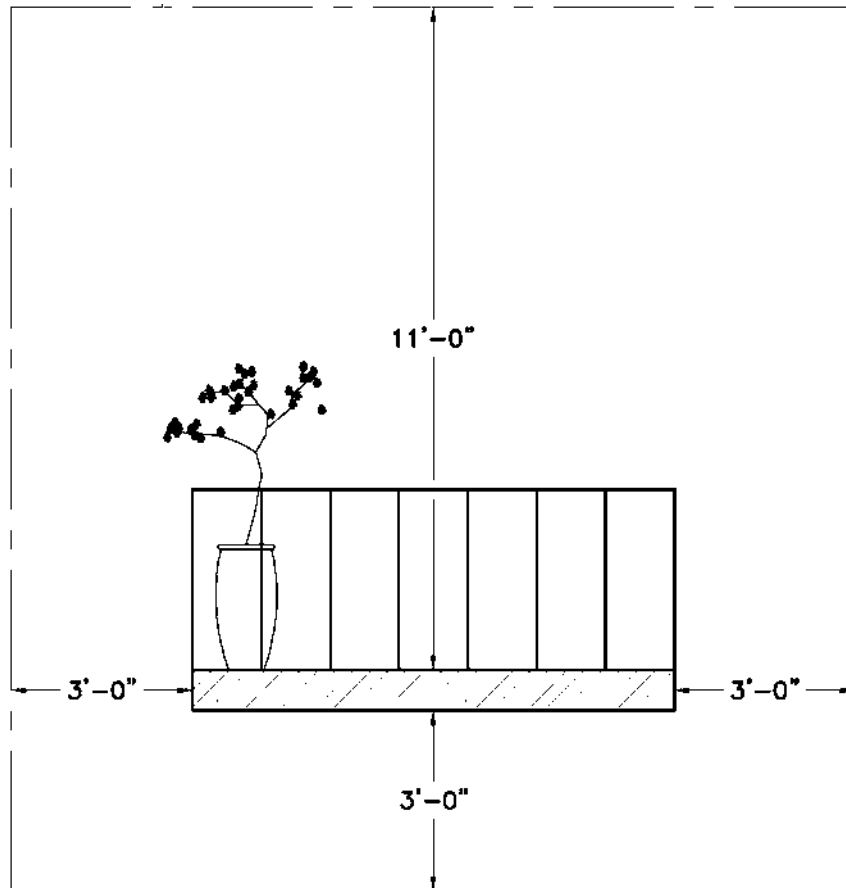
**Figure 3.1.4a. Clearances from Doors**



**Figure 3.1.4b. Clearances from Windows (Operable)**



**Figure 3.1.4c. Clearances from Balconies, Decks, or Similar Locations (ft)**



### 3.2 Installation

Weatherheads shall be installed no higher than 20 ft above final grade.

The customer shall furnish and install all required service entrance equipment up to the point of connection or demarcation per WAC 296-46B-230.

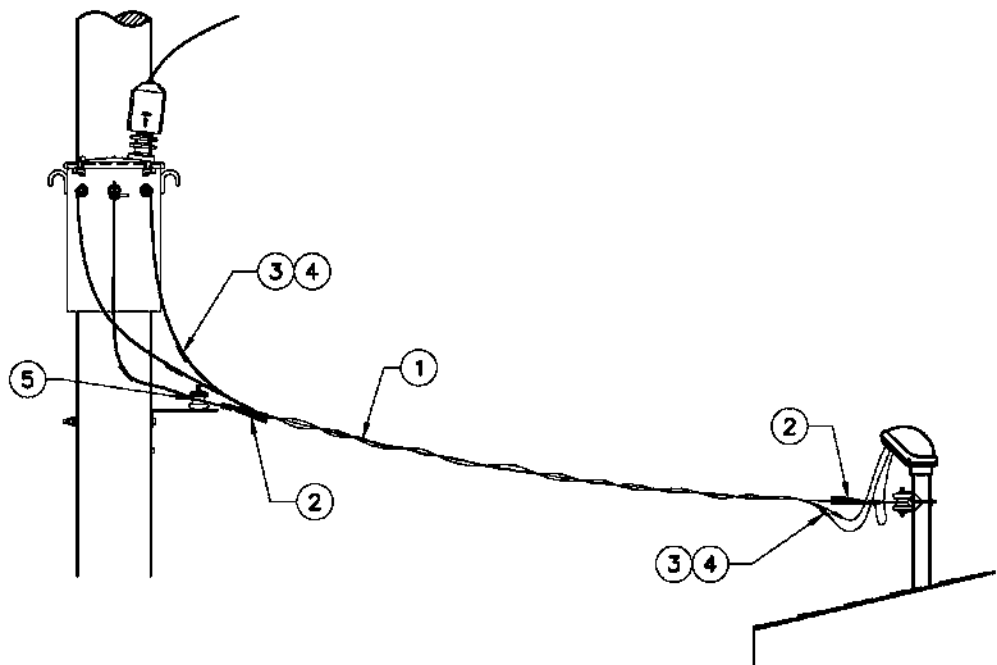
Only one service drop shall be allowed per service mast.

Service drops shall be installed as shown in Figure 3.2a.

Service drops shall be cleared and maintained, free of obstruction, by the customer.

Only power service drop conductors shall be permitted to be attached to a service mast.

**Figure. 3.2a. Service Drop Installation Details**



Guying or bracing of the roof support mast is required if the mast exceeds 26 inches above the roof line or if the service drop is longer than 100 ft. See WAC 296-46B-230 for installation details.

The roof support mast shall be located no greater than 4 ft from the nearest roof edge.

Communication service drops shall not be permitted on the service mast (above or below roof).

For multiple service connections at the service entrance or at the pole, multi-tap insulated connectors shall be used as follows:

- Three (3) multi-tap connectors for triplex
- Four (4) multi-tap connectors for quadruplex

**Figure 3.2b. Multi-Tap Insulated Connector, Stock. Nos. 013661 or 013662**



#### **4. Construction Notes**

For variances, pole guying, and clearances over structures and objects not listed in this standard, such as swimming pools and trolley conductors, consult with an SCL engineer.

Run continuous service conductor if possible.

Do not string service conductor to buildings at a tension that requires the use of automatic or straight-line clamps.



**5. Material Lists**

**Table 5a. Service Conductors, Overhead**

Fig	Compatible Unit	ID	Quantity						
3.2a	Wire, 350 kcmil Quadruplex Service	CNDOSVC1-350QP	-----						
3.2a	Wire, 4/0 Triplex Service	CNDOSVC1-4/0TP	-----						
3.2a	Wire, 4/0 Quadruplex Service	CNDOSVC1-4/0QP	-----						
3.2a	Wire, 1/0 Triplex Service	CNDOSVC1-1/0TP	-----						
3.2a	Wire, 1/0 Quadruplex Service	CNDOSVC1-1/0QP	-----						
3.2a	Wire, #2 AWG Triplex Service	CNDOSVC1-#2TP	-----						
3.2a	Wire, #2 AWG Quadruplex Service	CNDOSVC1-#2QP	-----						

#	Material Description	ID	↓	↓	↓	↓	↓	↓	↓
1	#2 AWG quadruplex	600734	1	-	-	-	-	-	-
1	#2 AWG triplex	600672	-	1	-	-	-	-	-
1	1/0 quadruplex	600735	-	-	1	-	-	-	-
1	1/0 triplex	600664	-	-	-	1	-	-	-
1	4/0 quadruplex	600738	-	-	-	-	1	-	-
1	4/0 triplex	600669	-	-	-	-	-	1	-
1	350 kcmil quadruplex	600741	-	-	-	-	-	-	1

**Table 5b. Service Connectors, Overhead**

Fig	Compatible Unit	ID	Quantity						
3.2a	Connectors, 350 kcmil Quadruplex Service	CNDOSVC1-350QPC	-----						
3.2a	Connectors, 4/0 Triplex Service	CNDOSVC1-4/0TPC	-----						
3.2a	Connectors, 4/0 Quadruplex Service	CNDOSVC1-4/0QPC	-----						
3.2a	Connectors, 1/0 Triplex Service	CNDOSVC1-1/0TPC	-----						
3.2a	Connectors 1/0 Quadruplex Service	CNDOSVC1-1/0QPC	-----						
3.2a	Connectors, #2 AWG Triplex Service	CNDOSVC1-#2TPC	-----						
3.2a	Connectors, #2 AWG Quadruplex Service	CNDOSVC1-#2QPC	-----						
			↓	↓	↓	↓	↓	↓	↓
#	Material Description	ID							
2	Neutral service wedge clamp, #6 AWG-#2 AWG	581340	2	2	-	-	-	-	-
2	Neutral service wedge clamp, #4 AWG-1/0	581342	-	-	2	2	2	2	2
2	Neutral service wedge clamp, 2/0-4/0	581344	-	-	-	-	2	2	2
3	Connector, comp., bare, #4 AWG-4/0	650104	4	3	4	3	-	2	-
3	Connector, comp., insulated, yellow-yellow	650569	-	-	-	3	-	-	-
3	Connector, comp., insulated, yellow-red	650565	-	3	4	-	-	-	-
3	Connector, comp., insulated, red-red	650564	4	-	-	-	-	-	-
4	Connector, comp., bare, 4/0-477 kcmil	650138	-	-	-	-	8	4	8
5	Connector, 2-bolt, bronze, clamp, 1/0-4/0 str.	669380	2	2	2	2	2	2	2

**Table 5c. Service Connectors, Multi-Tap**

Fig	Compatible Unit	ID	Quantity			
3.2b	Conn., Multi-Tap, #2 AWG–350 kcmil, 4-Position, TP	JMULT3-1K-4OH	—			
3.2b	Conn., Multi-Tap, #2 AWG–350 kcmil, 4-Position, QP	JMULT4-1K-4OH	—			
3.2b	Conn., Multi-Tap, #2 AWG–350 kcmil, 6-Position, TP	JMULT3-1K-6OH	—			
3.2b	Conn., Multi-Tap, #2 AWG–350 kcmil, 6-Position, QP	JMULT4-1K-6OH	—			

#	Material Description	ID				
3	Conn., multi-tap, #2 AWG–350 kcmil, 4-position	013661	–	–	4	3
3	Conn., multi-tap, #2 AWG–350 kcmil, 6-position	013662	4	3	–	–

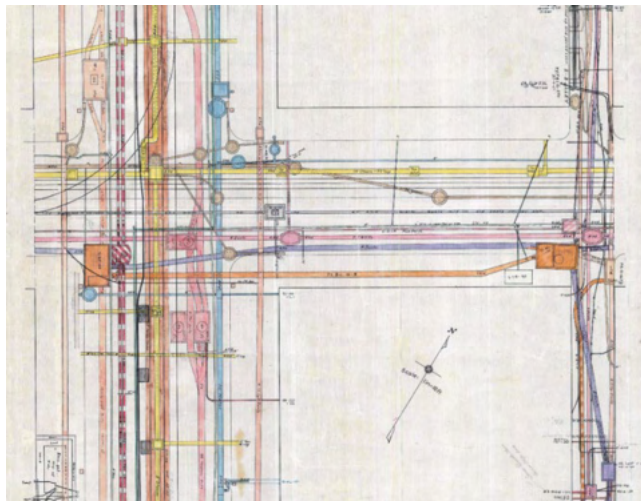
**6. References**

- SCL Construction Standard 0100.11**; “LR Bracket Installation”
- SCL Construction Standard 0130.10**; “Secondary Service Span”
- SCL Construction Standard 0130.20**; “Secondary Service Bridle”
- WAC 296-46B-230**; Wiring and protection–Services

**7. Sources**

- IEEE C2-2017**; National Electric Safety Code (NESC); 2017
- NFPA-70, National Electric Code (NEC) Article 230**, Fourteenth Edition, National Fire Protection Association, Quincy, MA, 2017
- Washington Administrative Code (WAC) 296-307-36609**; “What Requirements Apply to Conductors”
- Washington Administrative Code (WAC) 468-34-209**; “Vertical Clearance”
- Revised Code of Washington (RCW) 19.29.010**; “Inspections–Notice to repair and change–Disconnection–Entry–Concealment–Accessibility–Connection to utility–Permits, fees–Limitation–Waiver of provisions during state of emergency”
- Neuansourinh, Ponet**; SCL Standards Engineer, subject matter expert, and originator of 0130.30 (ponet.neuansourinh@seattle.gov)
- Lu, Curtis**; SCL Standards Engineer and subject matter expert for 0130.30 (curtis.lu@seattle.gov)

## Clearances Between SCL Underground Structures and Other Structures



### 1. Table of Contents

2. Scope .....	2
3. Application .....	2
4. Design and Construction Notes .....	2
4.1 Covers/Hatch .....	2
4.2 Vault Knockouts .....	2
Figure 4.2a. Knockout Zone, Plan View .....	3
Figure 4.2b. Knockout Zone, Elevation View .....	4
4.3 Shoring .....	4
4.4 Overhead Clearance for SCL Underground Structures .....	4
4.5 Access and Working Space for SCL Underground Structures .....	4
5. Minimum Clearances in the Right-of-Way between SCL Vaults or Handholes and Non-SCL Facilities, Conduits, and Pipes .....	5
Figure 5a. Minimum Horizontal Clearance, Plan View .....	5
Figure 5b. Minimum Horizontal Clearance, Elevation, Side View .....	6
6. Minimum Clearances in the Right-of-Way between SCL Conduits or Duct Banks and Non-SCL Facilities, Conduits, and Pipes .....	7
Figure 6a. Minimum Horizontal Clearance, Non-Water Structures, Plan View .....	7
Figure 6b. Minimum Horizontal Clearance, Water Structures, Plan View .....	8
Figure 6c. Minimum Vertical Clearance, Elevation View .....	9
7. Minimum Clearances on Private Property, between SCL Conduits or Duct Banks and Non-SCL Facilities, Conduits, and Pipes .....	10
Figure 7. Minimum Horizontal Clearance, Plan View .....	10
8. Minimum Clearances in the Right-of-Way between SCL Structures and Vegetation .....	11
Figure 8a. Vegetation Clearance, Plan View .....	11
Figure 8b. Vegetation Clearance, Elevation View .....	12

Standard Coordinator  
Brett Hanson

Standards Engineering Supervisor  
John Shipek

Unit Director  
Andrew Strong



9. Minimum Clearances in the Right-of-Way between SCL Structures and Various Other Structures .....	12
Table 9. Minimum Horizontal Clearances .....	13
Preferred Location .....	
10. Location and Orientation of Vaults and Secondary Handholes at Grade .....	13
10.1 577 Vaults .....	13
Figure 10.1.1 Preferred Location and Orientation for 577 Vault .....	13
Figure 10.1.2 Alternate Location and Orientation for 577 Vault .....	14
Figure 10.1.3 Location and Orientation for 577 Vaults with Junction Boxes ...	14
10.2 Secondary Handholes .....	15
Figure 10.2.1 Preferred Location for Secondary Handhole .....	15
Figure 10.2.2 Alternate Location for Secondary Handhole .....	15
11. References .....	16
12. Sources .....	16

---

## 2. Scope

This standard covers clearance requirements between Seattle City Light (SCL) underground structures and other utilities underground structures located in the public right-of-way and on private property. This includes both Network and Looped Radial underground structures. Underground structures include vaults, handholes, basins, fire hydrants, duct banks, conduits, pipes, and root balls.

This standard addresses the minimum required horizontal and vertical clearances between structures and required operating space.

The requirements may be code based or safety related.

---

## 3. Application

This standard shall be used by SCL engineers, operations personnel, consultants, and contractors when designing and/or constructing vaults, handholes, manholes, conduits below grade that are in the vicinities of other utilities installations. These could be gas, water, sewer, steam, telephone, cable TV, and fiber optics. Other utilities and contractors should also follow these provisions when installing their facilities near any SCL facility.

Reasons for maintaining these minimum clearances are for allowing enough space for future equipment maintenance, assuring a safe environment to the public, avoiding thermal interferences between cables, repair and replacement of other utilities, and minimizing impact of other utilities failures on SCL equipment and vice versa.

The minimum clearances defined in this document are per SCL specifications taking into account the City of Seattle Land Use Code, Right-of-Way Improvement Manual, and Standard Plans and Specifications; and the Washington Administrative Code (WAC). SCL specifications are derived from engineering and operations experience.

For any deviation from the prescribed clearances, an agreement has to be reached between SCL Engineering and the interested parties.

---

## 4. Design and Construction Notes

### 4.1 Covers/Hatch

When reviewing designs, engineers should take into account cover or lid size for future needs.

## 4.2 Vault Knockouts

The knockout zone shall be eight feet long and the width shall equal the width of the knockouts plus 2 ft. The height of the knockout zone shall be equal to the height of the SCL facility. This zone should be reserved for future extensions of SCL duct runs unless parties receive explicit permission from SCL Engineering.

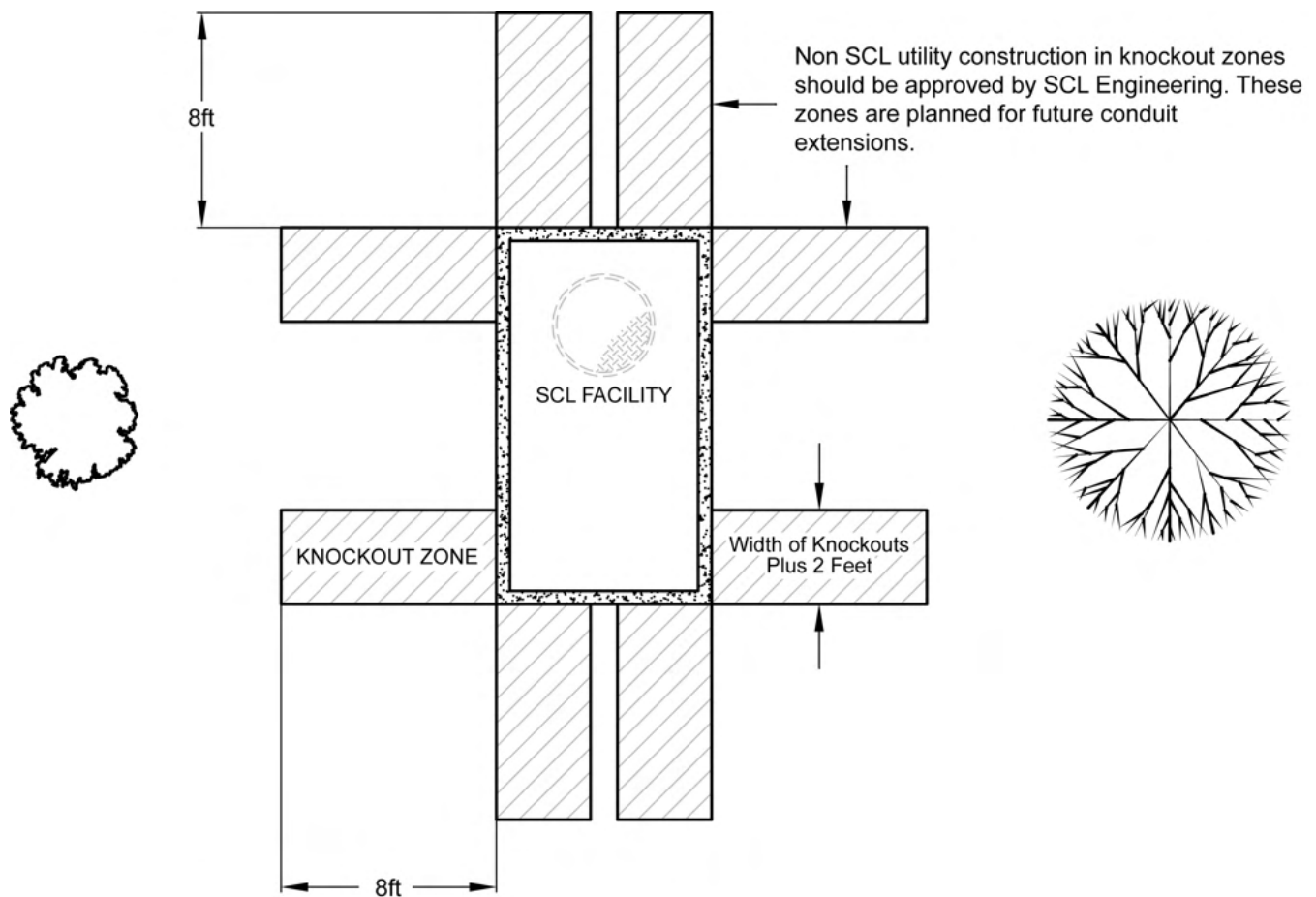
Non-SCL utility manhole construction in knockout zones shall be approved by SCL Engineering. These zones are planned for future conduit extensions. See Figure 4.2a.

No utility handholes or other underground structures shall be installed in the area outside and adjacent to knockouts. See Figure 4.2a.

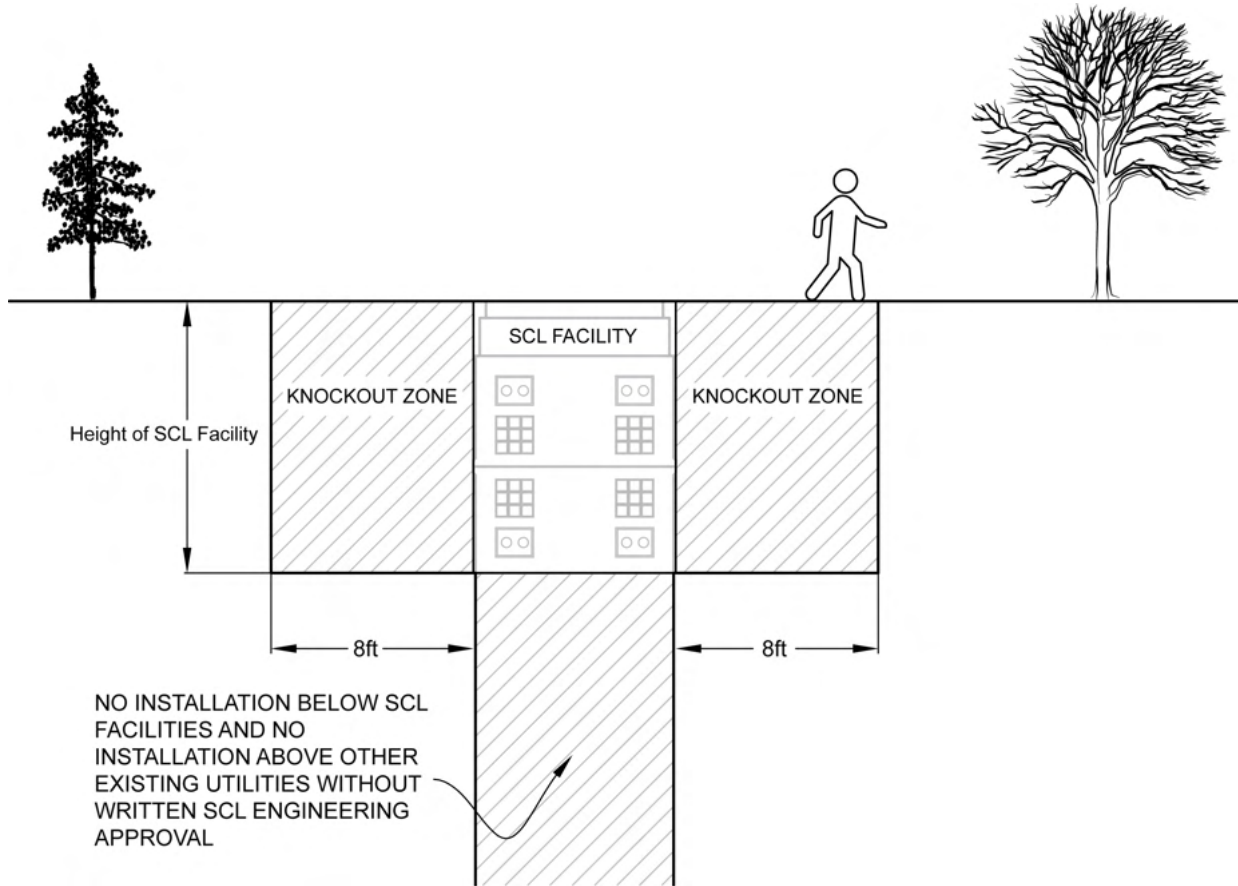
No installations below SCL facilities shall occur without written SCL Engineering approval. See Figure 4.2b.

No installations above other existing utilities' structures shall occur without written SCL Engineering approval. See Figure 4.2b.

**Figure 4.2a. Knockout Zone, Plan View**



**Figure 4.2b. Knockout Zone, Elevation View**



**4.3 Shoring**

During construction projects shoring piles and shoring lagging shall maintain a clearance from SCL conduits, duct banks, handholes, manholes and vaults of at least 1 ft.

**4.4 Overhead Clearance for SCL Underground Structures**

To allow crane access to SCL vaults and manholes for lowering and raising equipment, the minimum vertical height above the underground facilities, of overhead structures and any encumbrances, such as roadway columns, shall be 25 ft.

**4.5 Access and Working Space for SCL Underground Structures**

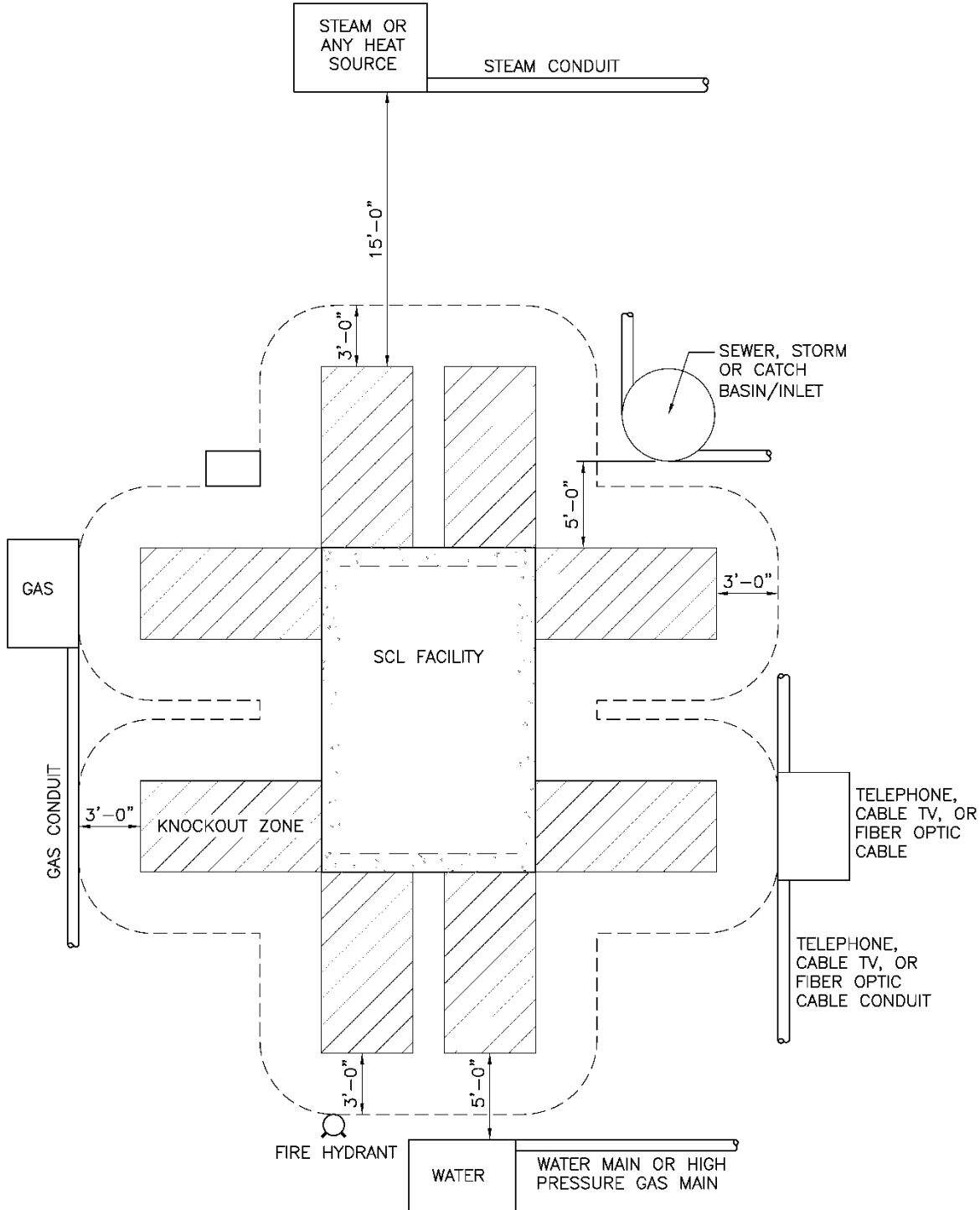
To allow crane access to SCL vaults and manholes, facilities must be located to allow permanent SCL vehicular (truck) access to the facility for installation and service of electrical equipment. SCL facilities must have a permanent, level, unobstructed, 8-ft wide working area adjacent to the facility for access to the facility and knockout zones.

**5. Minimum Clearances in the Right-of-Way between SCL Vaults or Handholes and Non-SCL Facilities, Conduits and Pipes**

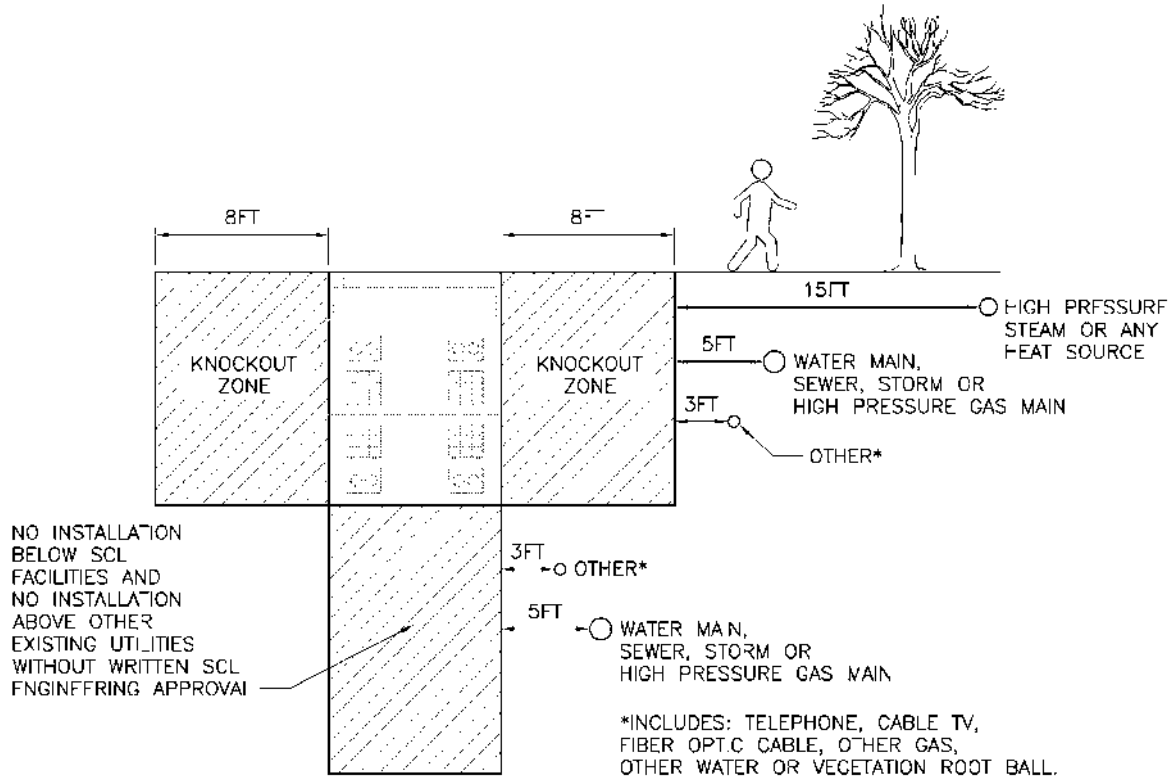
Non-SCL conduit can be 3 ft from SCL facility but must be below knockout zone.

If SCL knockout zones are planned for 115 kV or 230 kV facilities, horizontal clearance shall be 5 ft from SCL facilities to non-SCL facilities and conduits (except for high pressure steam or heat source).

**Figure 5a. Minimum Horizontal Clearance, Plan View**



**Figure 5b. Minimum Horizontal Clearance, Elevation, Side View**

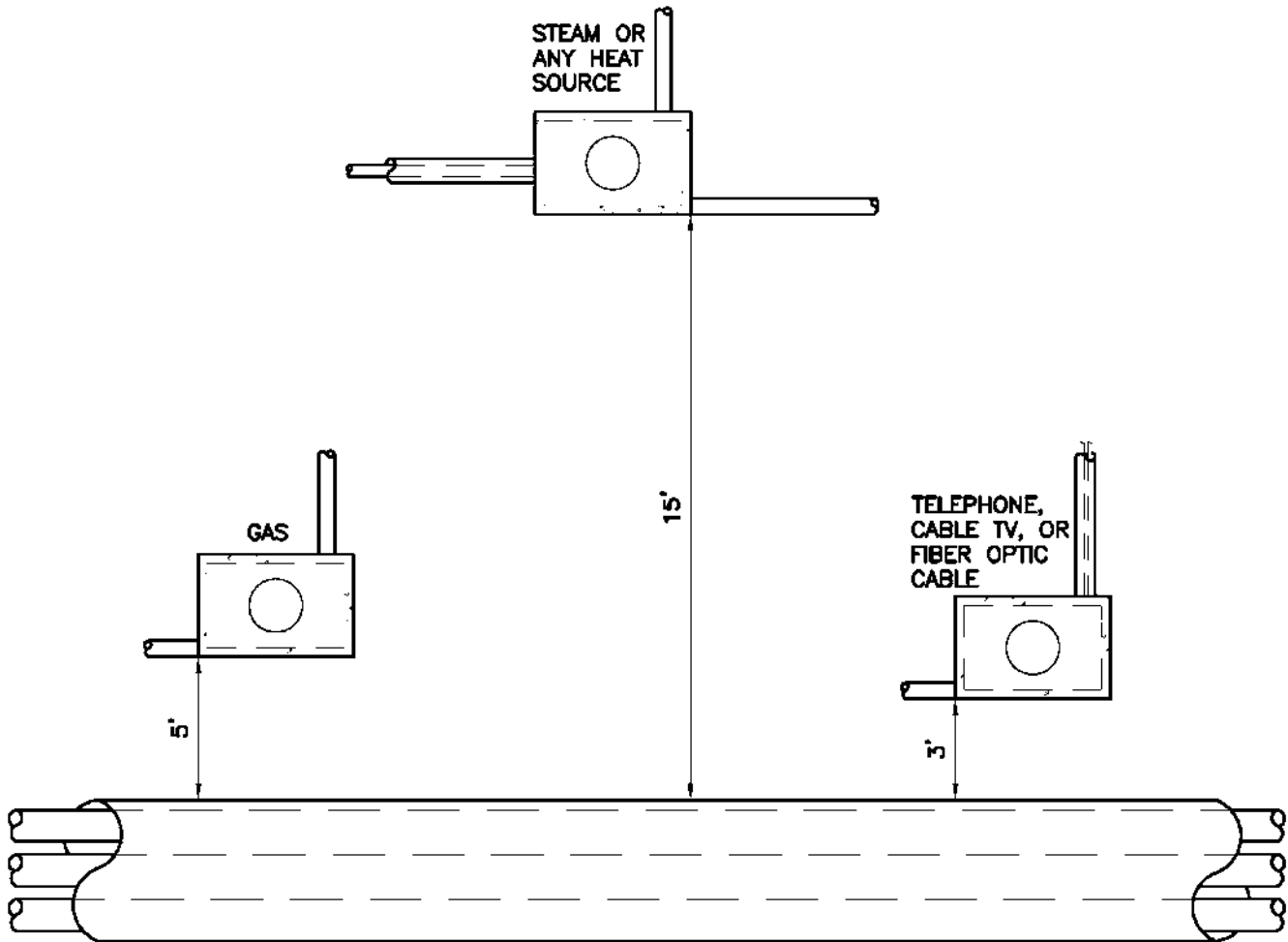


Note: If SCL knockout zones are planned for 115 kV or 230 kV, horizontal clearance shall be at least 5 feet between SCL knockout zones and non-SCL conduit or pipes.

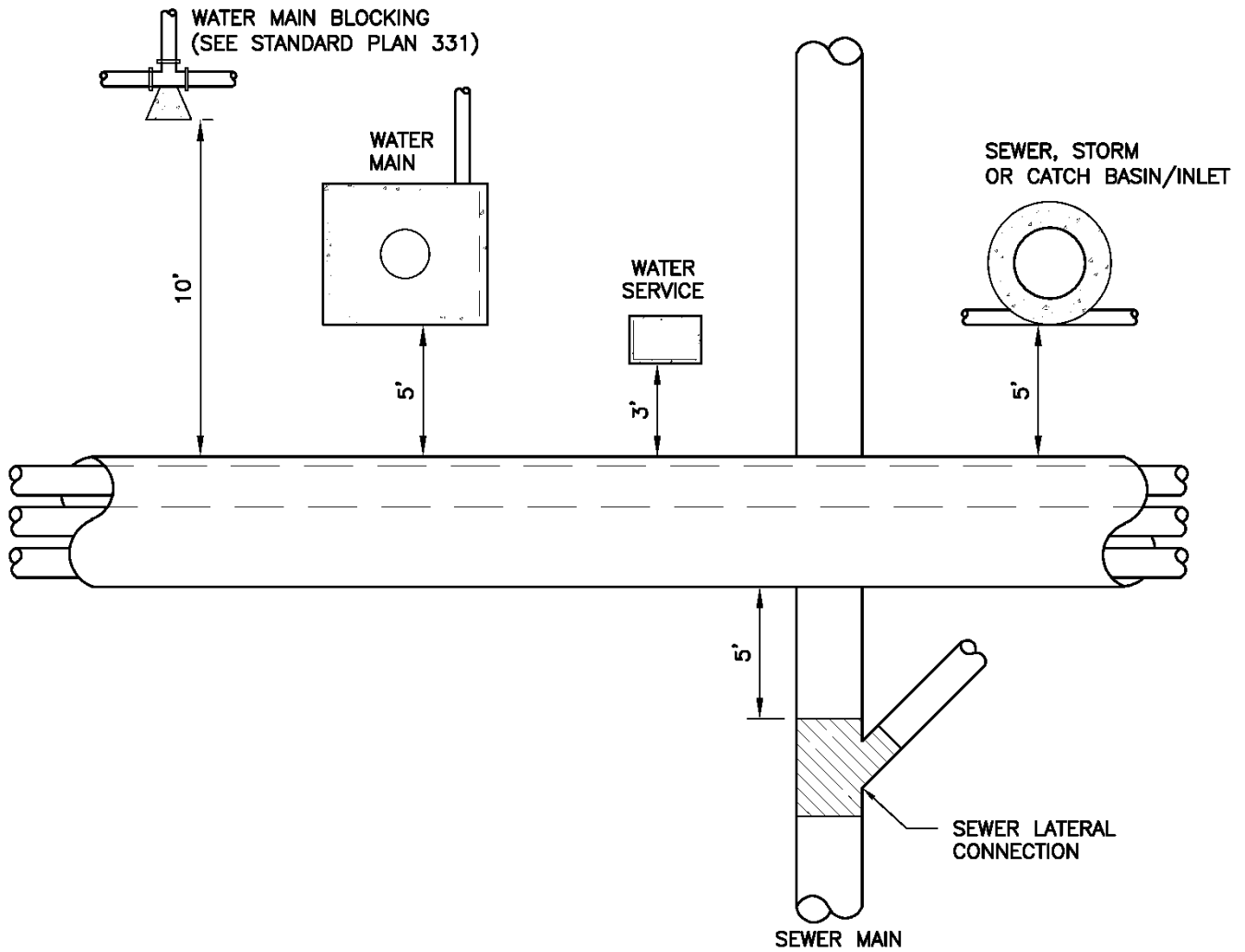
**6. Minimum Clearances in the Right-of-Way between SCL Conduits or Duct Banks and Non-SCL Facilities, Conduits and Pipes**

If SCL conduit or duct bank contains 115 kV or 230 kV, the horizontal clearance between SCL facilities and non-SCL facilities shall be a minimum of 5 ft and the vertical clearance shall be a minimum of 1 ft.

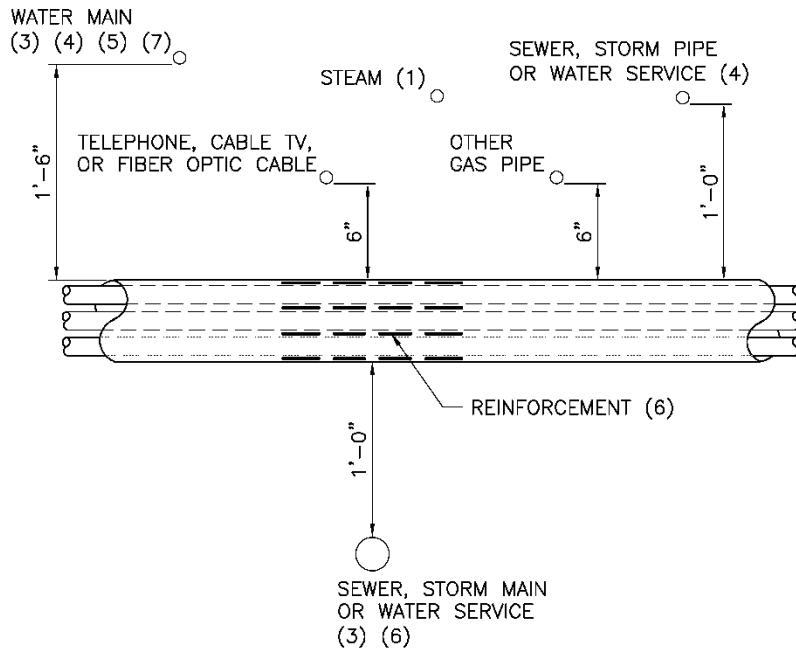
**Figure 6a. Minimum Horizontal Clearance, Non-Water Structures, Plan View**



**Figure 6b. Minimum Horizontal Clearance, Water Structures, Plan View**



**Figure 6c. Minimum Vertical Clearance, Elevation View**



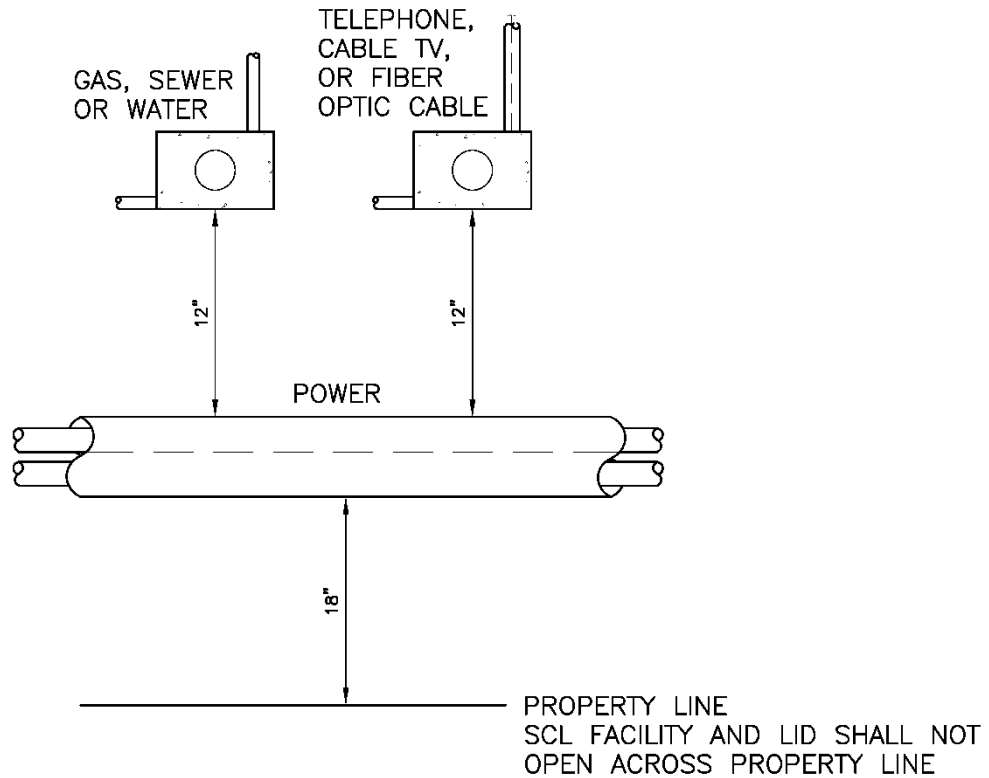
**Notes**

1. High pressure steam log or any heat source shall not cross SCL conduit or duct bank without SCL Engineering approval.
2. Vertical clearance applies to conduits crossing perpendicular underneath SCL conduits or duct banks. Non-SCL conduits are not allowed to be installed directly above or below parallel to SCL conduits or duct banks.
3. Crossing of sewer, storm, or water shall be perpendicular, except with written approval from SCL Engineering.
4. Backfill and bedding shall be installed as specified in Standard Plan 350 or 285, or per other AHJ.
5. Crossing under water, sewer, or storm laterals or mains requires support plan approved by the appropriate water AHJ and observation by that AHJ's construction management.
6. Conduit crossing over water, sewer, or storm laterals or mains shall be reinforced for a minimum of 5 ft to either side. See SCL U2-11.2/NDK-20.
7. Water, sewer, storm AHJ shall be notified when any cast iron pipe is exposed.



**7. Minimum Clearances on Private Property between SCL Facilities, Conduits, and Duct Banks and Non-SCL Facilities, Conduits, and Pipes**

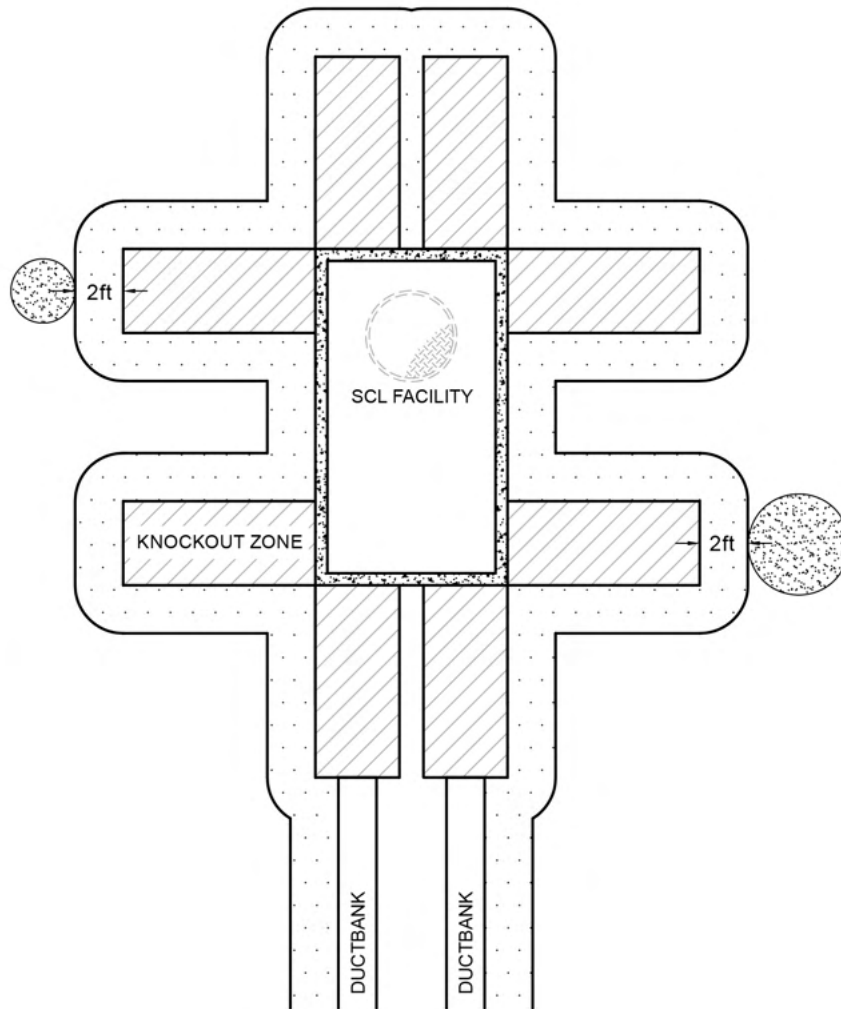
**Figure 7. Minimum Horizontal Clearances, Plan View**



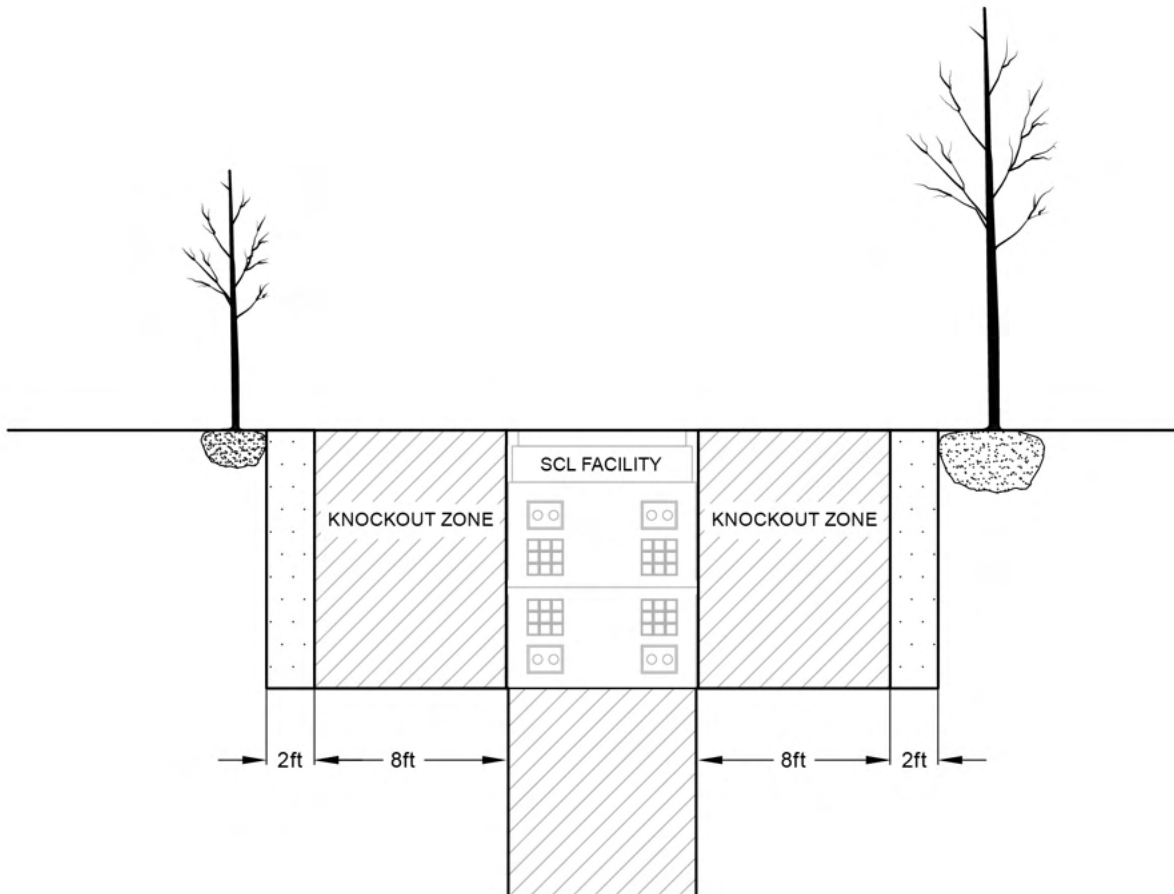
**8. Minimum Clearances in the Right-of-Way between SCL Structures and Vegetation**

There shall not be any planted trees, bushes, or shrubbery within 2 ft of SCL vaults, manholes, handholes, conduits, and duct banks. The distance shall be measured from the vegetation's root ball to the structure's surface.

**Figure 8a. Vegetation Clearance, Plan View**



**Figure 8b. Vegetation Clearance, Elevation View**



**9. Minimum Clearances in the Right-of-Way between SCL Structures and Various Other Structures**

No installation is allowed directly above or below SCL facilities without written SCL Engineering approval.

For setback or clearance requirements from bioretention cells and rain gardens, see Seattle Rights-of-Way Improvement Manual Chapter 4, 4.17.5.

**Table 9. Minimum Horizontal Clearances**

Other Structures	Horizontal Clearance from SCL Structures (ft)			
	Conduits or Duct Banks Rated to 26 kV	Conduits or Duct Banks Rated 115 or 230 kV	Vaults, Manholes, or Handholes	Adjacent to Knockouts
Fire hydrants/water meters	3	5	3	8
Street curbing	1	5	2 <sup>a</sup>	–
Building footings	3	5	3	–
Metro buses and strain poles (overhead operations)	3	5	3	–
Concrete support columns	3	5	3	8
Concrete support column footings	3	5	3	8
Temporary construction shoring piles	1	1	1	1
Water maintenance holes	5	5	5	8
CBs and inlets	3	3	3	8

a. To facility lid or hatch

**10. Location and Orientation of Vaults and Secondary Handholes at Grade**

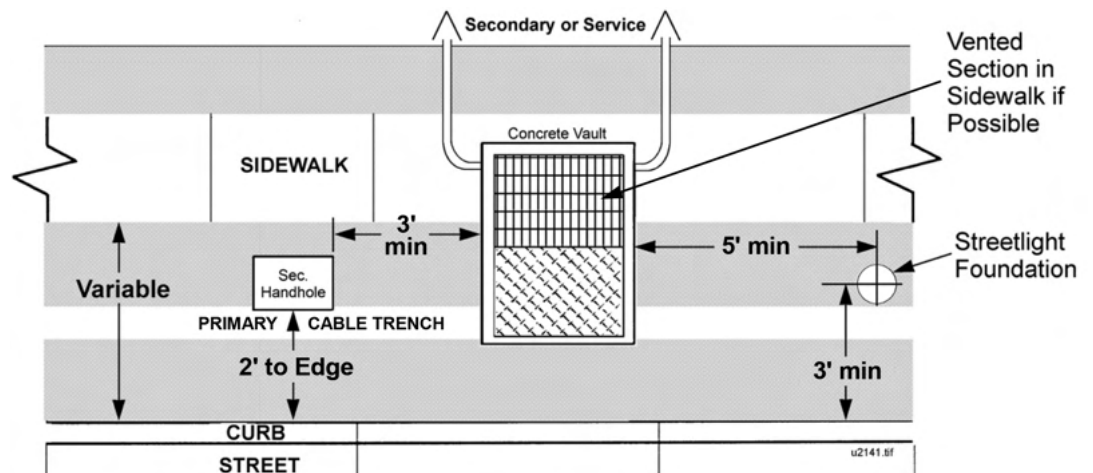
**10.1 577 Vaults**

577 vaults are typically used as a pulling vault or a loadbreak vault. The purpose of specifying the location and orientation of the vault is to ensure proper working space for SCL operations personnel.

**10.1.1 Preferred Location and Orientation**

The preferred orientation for a 577 vault is the length of the vault perpendicular to the curb as shown in Figure 10.1.1. For 577 vaults with junction boxes, additional clearances are required. See Figure 10.1.3.

**Figure 10.1.1 Preferred Location and Orientation for 577 Vault**



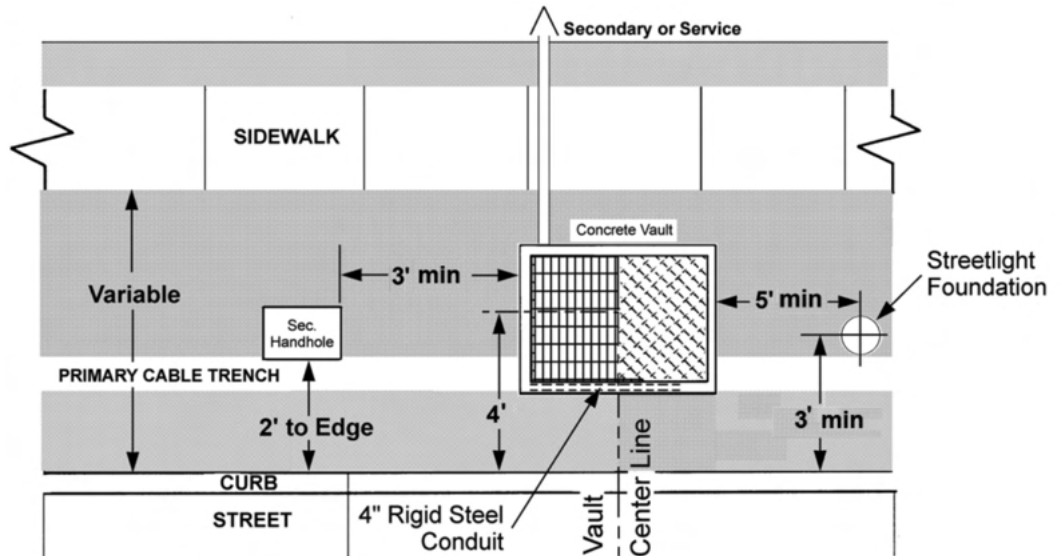
The vented section of the vault shall be located in the sidewalk.

When installed within a planting strip, the top of vault shall be set 1/2 inch above surrounding grade. Slope grade away from vault for drainage.

### 10.1.2 Alternate Location and Orientation

The alternate orientation for a 577 vault is the length of the vault parallel to the curb as shown in Figure 10.1.2. The location of the vault shall be entirely within the planting strip.

**Figure 10.1.2. Alternate Location and Orientation for 577 Vault**

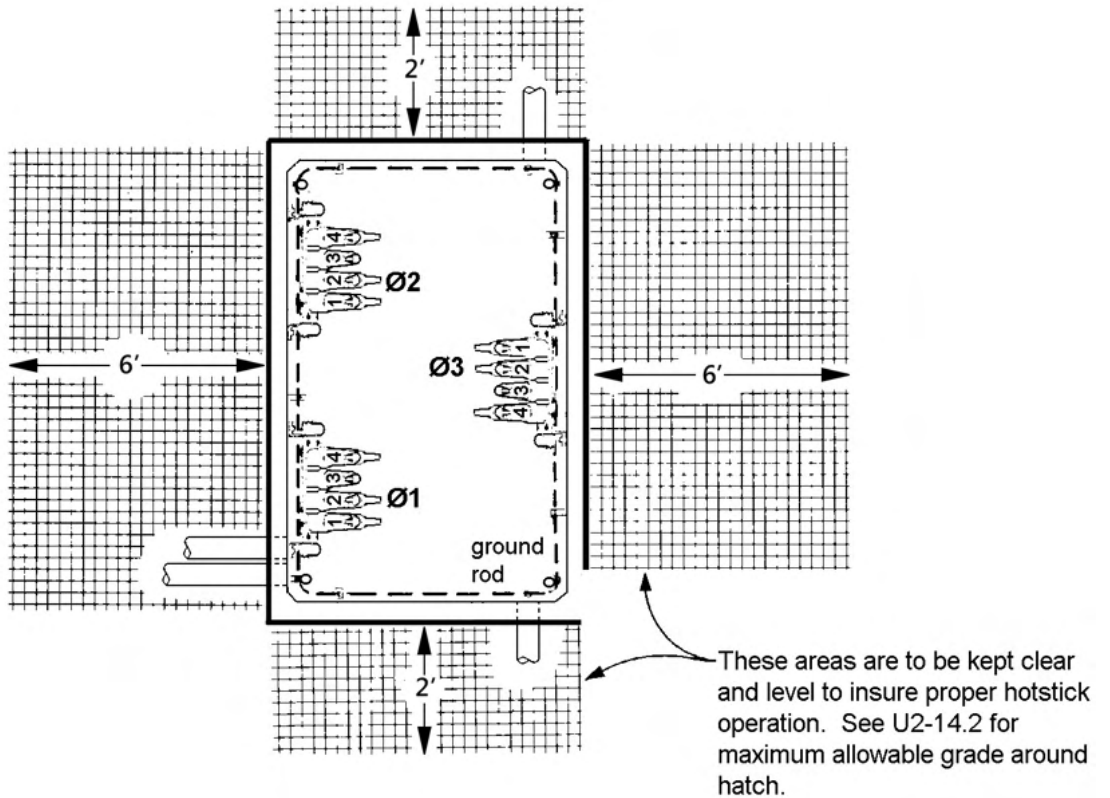


When vault or handhole extends into the sidewalk area because of a narrow planting strip, the vault or handhole shall be located entirely in the sidewalk with the edge flush with the street edge of the sidewalk and to the sidewalk grade. This applies only to the alternate location.

### 10.1.3 Location and Orientation for 577 Vaults with Junction Boxes

Additional clearances required for 577 vaults with junction boxes are shown in Figure 10.1.3.

**Figure 10.1.3 Additional Clearances Required for 577 Vaults with Junction Boxes**



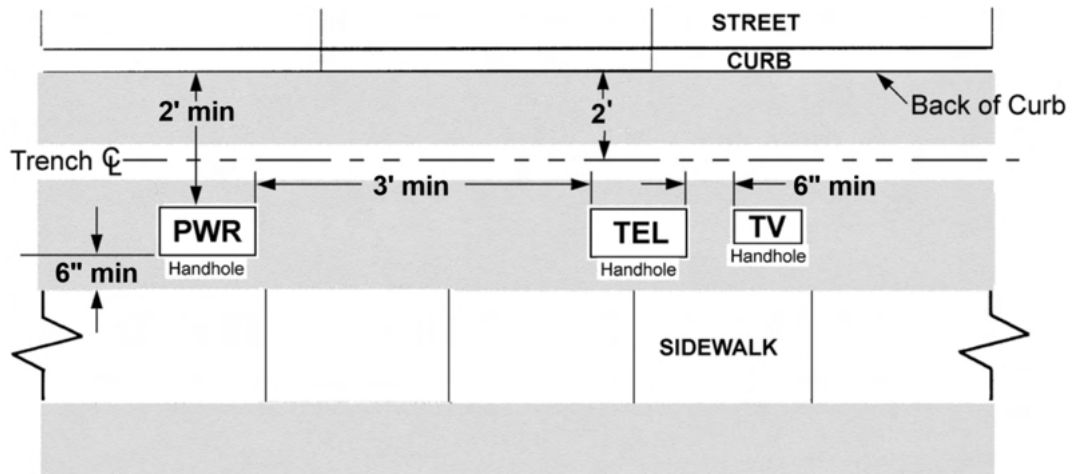
**10.2 Secondary Handholes**

The secondary handhole shall be oriented with the long side of the handhole parallel to the curb. Lid shall open away from curbs and streets and avoid pedestrian and bike paths.

**10.2.1 Preferred Location**

The preferred location is within the planting strip as shown in Figure 10.2.1.

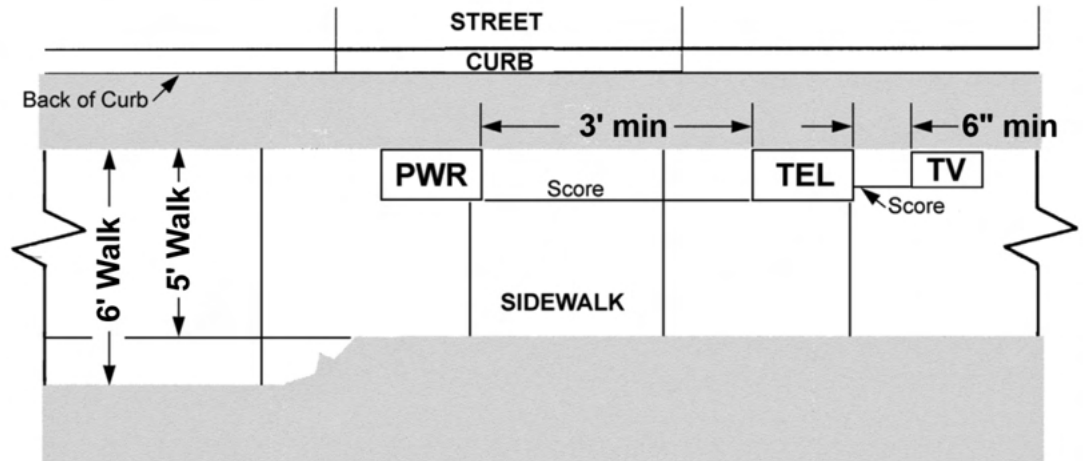
**Figure 10.2.1. Preferred Location for Secondary Handhole**



### 10.2.2 Alternate Location

When there is lack of space in the planting strip, the alternate location for a secondary handhole is along the street side of the sidewalk, as shown in Figure 10.2.2.

**Figure 10.2.2. Alternate Location for Secondary Handhole**



Restore sidewalk per requirements in city of Seattle Standard Plans for Municipal Construction, Standard Plan No. 420 or other Authority Having Jurisdiction (AHJ).

### 11. References

- SCL Construction Standard U2-11.2/NDK-20**; "Reinforcement of Concrete-Encased Duct Runs"
- SCL Construction Standard U2-14.2**; "Vault Installation"
- City of Seattle, Seattle Right-of-Way Improvement Manual**
- City of Seattle Standard Plans for Municipal Construction**
- City of Seattle Standard Specifications for Road, Bridge, and Municipal Construction**

### 12. Sources

- City of Seattle Standard Plan No. 030**; "Standard Locations for Utilities (Residential Street)"
- City of Seattle Standard Plan No. 285**; "Pipe Bedding Sewer/Storm Drain"
- City of Seattle Standard Plan No. 331**; "Watermain Thrust Drain Blocking Horizontal Fittings"
- City of Seattle Standard Plan No. 350**; "Watermain Trench and Bedding"
- City of Seattle Standard Spec 1-07.17(2)**; "Utility Clearances"
- Hall, Alan**; SCL Engineer and subject matter expert for 0214.00
- NESC C2-2012, Part 3**; "Safety Rules for Underground Lines"
- Panomvana, Tanya**; SCL Standards Engineer and originator of 0214.00
- SCL Construction Guideline U2-10/NDK-50** (canceled); "Electrical Conduit and Facilities in Public Rights-of-Way"

**SCL Construction Guideline U9-6**; “577 Vault with Three Loadbreak Junction Boxes – Installation, Grounding and Connections”

**SCL Construction Standard 0232.05** (canceled); “Underground Residential Equipment Location of 577 Vaults and Secondary Handholes”



---

## Customer Requirements for Trenching in the Right-of-Way

---

### 1. Scope

This standard covers the customer requirements for trenching in the public right-of-way for underground electric service conduit installation.

Trenching in private property is outside the scope of this standard.

---

### 2. Application

This standard is for Seattle City Light (SCL) engineers, crews, Electric Service Representatives (ESRs), Electric Service Engineers (ESEs), customers, and contractors who design and/or construct underground conduit that requires trenching in the public right-of-way.

---

### 3. Definitions

**Trenching:** Excavation, backfill and surface restoration necessary for the installation of conduit.

**Public Right-of-Way:** Property dedicated to public use outside of private property lines.

---

### 4. Requirements

#### 4.1 General

Trenching in the public right-of-way within the SCL service area shall be done in accordance with SCL Standards and SCL Requirements Letter with job-specific requirements.

All work must also adhere to the requirements per the City of Seattle Right-of-Way Improvements Manual, Streets Illustrated, and the City of Seattle Standard Plans for Municipal Construction, which are the comprehensive resources for requirements, procedures, standards, and guidelines affecting physical changes in the public rights-of-way or the requirements of the authority having jurisdiction (AHJ) if outside Seattle city limits.

All other project-related work, including excavation, backfill, and surface restoration shall also meet the requirements of the above-stated SCL standards and SCL Requirements Letter with job-specific requirements.

A qualified SCL electrical worker is required as a safety standby whenever entry into an energized SCL facility is needed, regardless of the voltage.



The customer/contractor shall be responsible for calling the “One-Call” locator service and for notifying all other utilities who may not subscribe to the One-Call locator service. A toll-free number, 1-800-424-5555, or “811” is available for notifying most Seattle area utilities, including those located in King County. This does not relieve the customer/contractor from notifying all other utilities of the intent to excavate. The customer/contractor must follow all the applicable state guidelines as specified in RCW 19.122.

#### **4.2 Permits**

The customer/contractor is responsible for obtaining necessary permits from the appropriate jurisdiction’s permit-issuing authority prior to commencing work.

SCL franchise cities and Unincorporated King County (UKC) areas served by SCL shall coordinate with the appropriate AHJ to obtain permits for their customers to trench in the public right-of-way as specified in the AHJ’s regulations.

If customers are not allowed to trench in the right-of-way by their respective county, franchise city, or UKC area, SCL will perform all service installation work per SCL’s work schedule in accordance with the Service Installations Policy, DPP 500 P III-417. SCL will obtain the permit and perform all civil construction work. This will be considered extraordinary work for which the customer shall be billed.

#### **4.3 Administrative Charges**

The contractor shall be responsible for administrative costs by the permit-issuing authority, and bonding requirements of both SCL and the permit-issuing authority.

SCL inspection and review charges, if applicable will be assessed in addition to those charged by other inspecting authorities.

#### **4.4 Inspections**

The customer/contractor is responsible for contacting an SCL Electric Service Representative or Electric Service Engineer to schedule inspections to ensure all workmanship is done in accordance with SCL construction standards.

All post-trenching backfill and surface restoration work shall be inspected by the customer’s associated AHJ.

---

#### **5. References**

**State of Washington, Underground Utilities Law, 2011**; Chapter 263, codified in Chapter 19.122 RCW

**DPP 500 P III-417**; Service Installations

**City of Seattle Streets Illustrated Right-of-Way Improvements Manual**

**City of Seattle Standard Plans for Municipal Construction**

---

#### **6. Sources**

**Lu, Curtis**; SCL Standards Engineer and originator of 0221.01 (curtis.lu@seattle.gov)

**DPP 500 P III-424** (canceled)

## Requirements for Primary Conduit and Duct Bank Installation



### 1. Table of Contents

2. Scope .....	2
3. Application .....	2
4. Requirements .....	2
4.1 General .....	2
4.2 Depth .....	2
4.3 Alignment .....	2
5. Primary Conduit and Duct Bank Construction .....	4
5.1 Arrangement .....	5
5.2 Termination .....	5
5.3 Changes in Direction .....	6
6. Conduits .....	7
7. Trench .....	7
8. Spacers .....	7
9. Encasement .....	8
10. Backfill .....	8
10.1 Types of Backfill .....	8
10.2 Requirements .....	8
11. Identification .....	8
12. Inspection .....	9
13. Communications .....	9
14. Additional Network Conduits .....	9
15. References .....	9
16. Sources .....	10

Standard Coordinator  
Brett Hanson

Standards Engineering Supervisor  
John Shipek

Division Director  
Andrew Strong

## 2. Scope

This standard provides the general requirements for the construction and installation of primary conduits and duct banks in the public right-of-way and on private property within the Seattle City Light (SCL) service territory. This includes system duct banks of more than two conduits, and primary service duct banks with only two conduits.

Job-specific requirements are not covered in this standard. Refer to the SCL Requirements Letter for job-specific requirements.

## 3. Application

This standard provides direction to SCL crews, engineers, customers, electrical service representatives, reviewers, inspectors, and contractors about where and how to properly install primary (601 – 50,000 V) conduits and duct banks in the public right-of-way and on private property.

For secondary (0 – 600 V) conduit installations, refer to SCL 0224.07.

For clearances between underground structures, refer to SCL 0214.00.

## 4. Requirements

### 4.1 General

Conduits and duct banks shall conform to Table 4.1 and Figures 4.3a and 4.3b.

**Table 4.1. General Requirements**

Function	System	Service
Voltage	601 – 50,000 V	601 – 50,000 V
Location	Right-of-way and private property	Right-of-way and private property
Area	Network and Looped Radial	Network and Looped Radial
Cover (minimum)	36 in	36 in
No. of Conduits (minimum)	2	2
Encasement	Yes	Yes
Marking Tape	Yes	Yes
Backfill	CDF	CDF

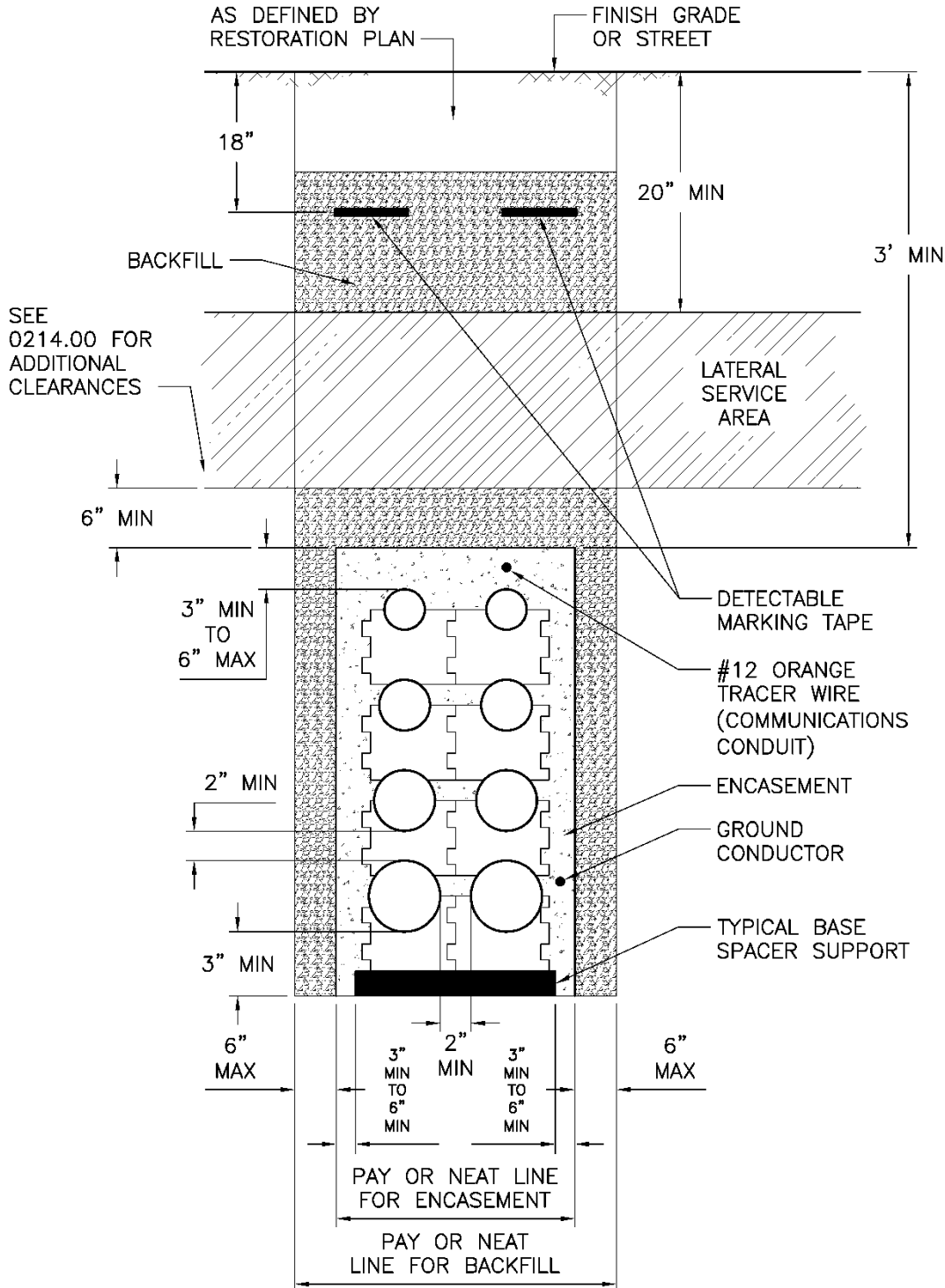
### 4.2 Depth

See Table 4.1 for minimum cover.

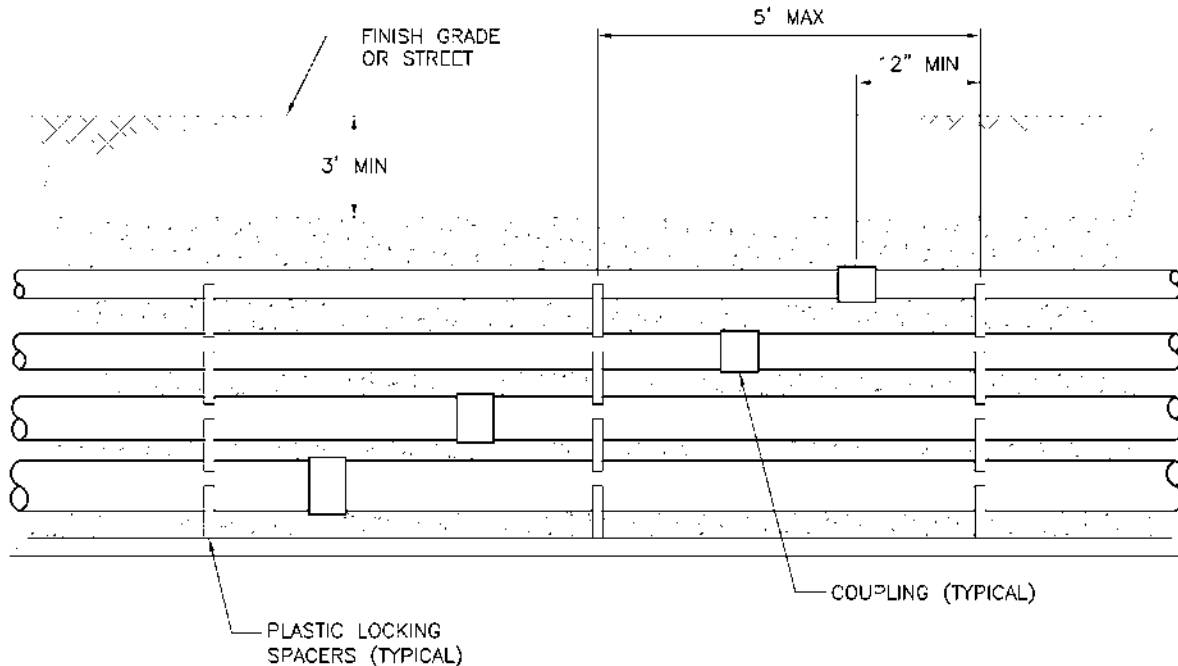
### 4.3 Alignment

Center line of the duct bank shall be located 15 feet from center line of street on either side of the street unless otherwise specified by the SCL engineer.

**Figure 4.3a. Primary Duct Bank, End View**



**Figure 4.3b. Primary Duct Bank, Side View**



## 5. Primary Conduit and Duct Bank Construction

Duct banks and conduit systems are electrical facilities for power distribution. In order for the electrical system to perform at its full capacity, the following requirements shall be met:

- Systems shall be constructed in a neat and workmanlike manner.
- All joints shall be tightly sealed against water intrusion. For transition joints (steel to PVC, steel to fiberglass) and set screw coupling joints, apply a layer of mastic tape (Stock No. 736470) and a layer of electrical tape (Stock No. 736656) on top.
- All coupling and adapter threads shall be sealed with Oatey Great White pipe joint compound or equal with approval prior to installation.
- All joints shall be properly aligned and square, and have adequate cure time.
- All edges shall be deburred and chamfered to prevent damage to cables. See SCL 7015.05.
- Conduit runs shall be adequately supported so they do not become distorted during encasement or backfill.
- Conduit bends shall be concentric and maintain consistent spacing.
- Set screw couplings shall be encased.

Installations that do not meet these criteria will be rejected.

### 5.1 Arrangement

#### 5.1.1 Transposition

Conduits shall NOT be transposed between vaults.

### 5.1.2 Numbering

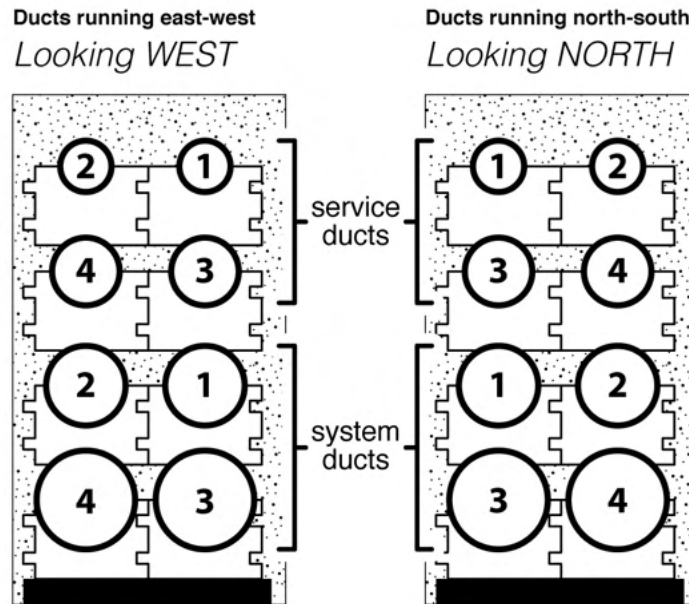
The ducts shall be numbered separately by type; service ducts together and system ducts together. The numbering method shall be as follows:

For ducts running east-west, count from north to south and from top to bottom.

For ducts running north-south, count from west to east and from top to bottom.

Example shown in Figure 5.1.2.

**Figure 5.1.2. Duct Numbering Example**



## 5.2 Termination

### 5.2.1 Permanent

The first two feet of all conduits exiting the vault shall be vertically and horizontally perpendicular to the vault face. Conduits shall enter the vault no more than 18 inches from the adjacent wall.

If there are multiple duct banks or direct-buried conduits entering horizontally and at right angles to each other in the same corner of a vault, manhole, or handhole, they shall enter at different elevations so they are vertically offset to the other.

All duct terminations into vaults, handholes, etc., shall be done by core drill. Core size shall be one trade size larger than conduit trade size.

Provide and install PVC-type DB-120 conduit end bells flush with the interior walls on all conduits entering the vault. The conduits shall be grouted both inside and outside of the vault. See SCL 7055.09 for approved manufacturers.

For terminating existing ducts in new vaults, see U2-11.3/NDK-30.

### 5.2.2 Temporary

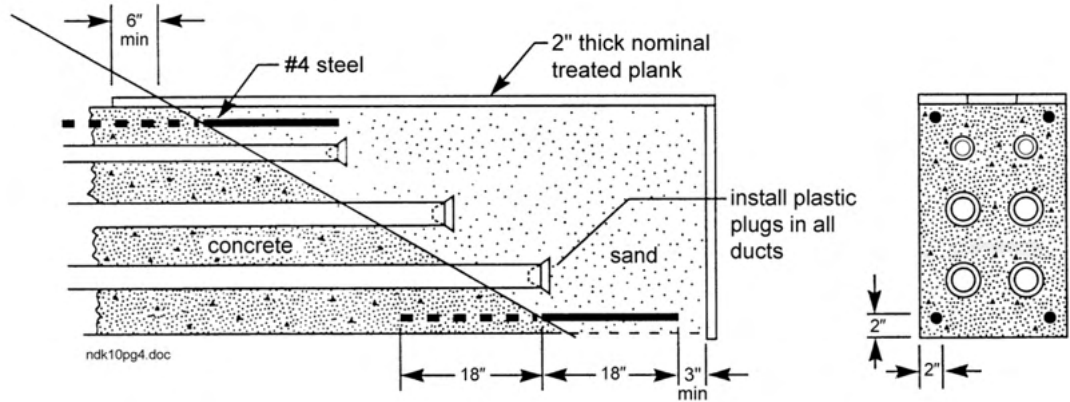
Install reinforcement steel dowels whenever placing of encasement is to be delayed beyond initial set.

Spacers shall be placed as close to the temporary termination as possible in order to maintain proper conduit spacing.

Lower conduit shall be flush or protrude beyond the conduit above it to ease reattachment.

See Figure 5.2.2 for details.

**Figure 5.2.2. Temporary Termination**



**5.3 Changes in Direction**

Any changes in direction must consist of only one type of conduit material and all bends must have the radius of the largest conduit. See Table 5.3 for minimum bend radius requirements.

For a horizontal change in direction, the PVC conduit may be cold-formed, provided the deflection does not exceed 1 ft per 10-ft section.

For standard wall fiberglass conduit, lateral deflection shall not exceed 1 ft per 20-ft section.

Each conduit bend shall be mandreled prior to placement and encasement. See SCL U2-11.40/NDK-40.

Conduits installed on private property must include a proper transition on the private property when meeting up with conduit in the right-of-way that requires a minimum 36-in cover.

**Table 5.3. Minimum Bend Radius**

Conduit (in)	System <sup>1, 3</sup> (in)	Service <sup>2, 3</sup> (in)	Communication (in)
2.5	—	24	—
3	144	36	—
4	144	48	48
5	150	60	—
6	144	60	—

Notes:

<sup>1</sup> PVC conduit is not allowed for system conduit bends.

<sup>2</sup> Bending PVC conduits with heat is not allowed.

<sup>3</sup> Typical unless otherwise specified by SCL engineer.



## 6. Conduits

Schedule 40 PVC, rigid steel or fiberglass conduits can be used in conduits and duct banks as specified in Table 6.

**Table 6. Allowed Conduit Materials**

	<b>Schedule 40 PVC (SCL 7015.05)</b>	<b>Rigid Steel (RGS) (SCL 7050.05)</b>	<b>Fiberglass (SCL 7025.05)</b>
System – Straight	Yes	Yes	Yes
System – Bend	No	Yes	No <sup>1</sup>
Primary Service – Straight	Yes	Yes	Yes <sup>2</sup>
Primary Service – Bend	No	Yes	No <sup>1</sup>
Communication – Straight End Bend	Yes	Yes	No

<sup>1</sup> Typical unless otherwise specified by SCL engineer.

<sup>2</sup> Only for 5-inch conduits.

Conduits entering an in-building vault or within a building footprint shall be steel.

Conduits exposed under aerial structures (bridges, etc.) shall be steel and effectively grounded.

Conduits installed under, or through, wall or structural sections shall be steel.

Factory and field straight-cut ends shall be chamfered throughout the duct run. See SCL 7015.05.

The conduit shall be RGS if there is 10 ft or less between bends (except communication conduits).

Allow two hours minimum to cure conduit adhesive prior to encasement.

A spare conduit shall be provided.

## 7. Trench

The bottom of the trench shall be free of debris and fine-graded by hand to remove sharp, embedded rocks and loose stones over 1/2 inches in size. Or, the trench shall be over-excavated and replaced with bedding material to cover protruding rocks and stones by a minimum of 2 in. The bottom shall be graded even. Bedding material shall be sand.

There shall be no standing water in the trench during the High Strength Fluidized Thermal Backfill (HSFTB) placement.

## 8. Spacers

Spacers for conduit separation shall be plastic lock-type (see SCL 7015.80) of such configuration to give the required separation between conduit and earth, as shown in Figure 4.1.

Horizontally, spacers shall be placed a maximum of 5 ft apart in both straight and bending sections of duct banks and a minimum of one foot away from any coupling, fitting, or end bell, as shown in Figure 4.2.

Base spacers shall be used to obtain clearance to subgrade material under the conduit for the placement of the 3-in minimum of encasement.

Base spacers may also be used to obtain 3-in side cover of conduit in bends.

Two-inch nominal concrete blocking, 16-in by 8-in by 1.75-in minimum, shall be provided under the base spacers.

Secure conduit to spacers in order to prevent floatation and deflection during encasing.

## 9. Encasement

Conduit encasement is required if the conduits used are for cable rated 601 V or higher.

The encasement shall be red HSFTB. HSFTB is a concrete mix and is the only allowed material for encasement:

- Refer to Material Standard 7150.00 for HSFTB requirements.
- Refer to Construction Standard 0226.06 for HSFTB installation.
- Allow 48 hours to cure prior to pulling cable.

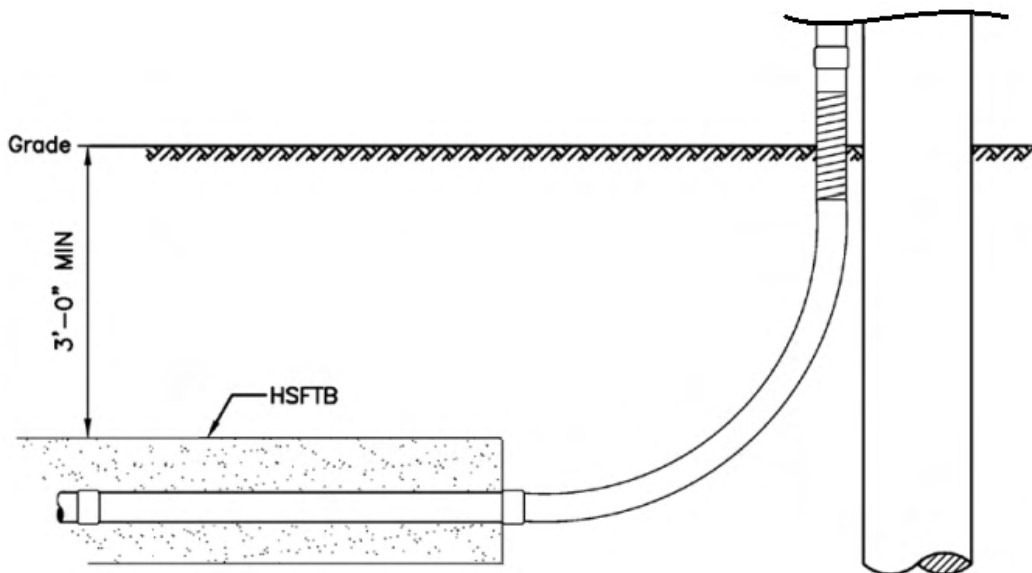
Forming is required for encasement:

- No forming or shoring structures shall be left in the trench after encasement.
- Metallic leave-in-place type forms may be allowed with permission of an SCL engineer. After curing, all forms and staking shall be cut flush with the top of the duct bank.

The encasement shall be a minimum of 3 in and a maximum of 6 in around all conduits in a duct bank.

The encasement shall end before the elbow of the conduit riser.

**Figure 9. Encasement at the Conduit Riser**



## 10. Backfill

**Controlled Density Fill (CDF)** – A self-compacting material used for backfill. Refer to SCL 7150.30 for CDF specification.

## 11. Identification

Install two 3-in-wide red detectable underground marking tapes over the corners of the duct bank at 18 in below the finished grade.

## 12. Inspection

Inspections shall be done by Seattle City Light. Conduit and duct bank installations require that the inspection be done when laying conduit, prior to, and during, encasement pour; and prior to, and during, backfill pour. Additional inspections may be done for more complex installations. Inspection approvals are required prior to moving on to the next stage of conduit and duct bank construction. An inspection may include verification of proper construction, adherence to engineer design and SCL standards, and conduit mandreling and cleaning. See SCL U2-11.40/NDK-40 for mandreling and cleaning details.

---

## 13. Communications

On all new underground installations of system conduits and duct banks, two 4-in PVC conduits shall be installed for communication uses. The two communication conduits shall be placed above the power conduits in looped radial duct banks and above the 2-in conduits in network duct banks. A 4 ft x 4 ft x 4 ft handhole is required for splicing when specified by the SCL engineer. Provide each communication duct bank with a continuous orange jacketed #12 stranded copper tracer wire installed above the conduits, submerged in the conduit encasement material. Leave 10 feet of each tracer wire coiled at each vault or handhole. If a conduit is terminated outside a vault or handhole, leave 4 feet of each tracer wire coiled in the end of the conduit. If the communication conduits leave the duct bank, they shall be encased in red HSFTB. See U2-11.40/NDK-40 for cleaning, mandreling, and pull tape requirements.

---

## 14. Additional Network Conduits

On all new underground network installations of conduits and duct banks, two 2-in PVC conduits shall be installed. The two conduits shall be placed below the communication conduits in network duct banks. The 2-in conduits are typically used for system grounds, vault lighting and vault discharge. If the bend radius is greater than 10 ft, the 2-in PVC conduit may be cold-formed to match the rest of the duct run. If the bend radius is less than 10 ft, RGS elbows are required.

---

## 15. References

**SCL Construction Standard 0214.00**; "Clearances between SCL Underground Structures and Other Utility Structures in the Public Right-Of-Way"

**SCL Construction Standard 0224.07**; "Requirements for Secondary Conduit Installation"

**SCL Construction Standard 0226.06**; "Installation of Fluidized Thermal Backfill"

**SCL Construction Standard U2-11.3/NDK-30**; "Termination of Existing Duct Banks in New Vaults or Manholes"

**SCL Construction Standard U2-11.40/NDK-40**; "Mandreling and Cleaning Of Ducts and Conduits"

**SCL Material Standard 7015.05**; "Schedule 40 PVC Conduit and Fittings"

**SCL Material Standard 7015.80**; "Conduit Spacers for PVC and FG Conduit"

**SCL Material Standard 7025.05**; "Fiberglass Conduit and Fittings, Standard-Wall, Five-Inch IPS"

**SCL Material Standard 7050.05**; "Zinc-Coated Steel Conduit and Fittings"

**SCL Material Standard 7055.09**; “DB120, PVC Conduit Fittings”

**SCL Material Standard 7150.00**; “Fluidized Thermal Backfill”

**SCL Material Standard 7150.30**; “Controlled Density Fill”

---

## 16. Sources

**City of Seattle Plans for Municipal Construction**; City of Seattle, 2011 edition

**Edwards, Tommy**; SCL Inspector and subject matter expert for 0222.02

**Lu, Curtis**; SCL Engineer and originator of 0222.02

**Perander, Eivind**; SCL North Distribution Engineer and subject matter expert for 0222.02

**SCL Construction Standard NDK-10** (canceled) “Installation of Nonmetallic Conduit with FTB Concrete Encasement”

**SCL Construction Standard U2-11** (canceled) “Installation of Nonmetallic Conduit with Concrete or FTB Encasement”

**Stewart, Bob**; SCL Inspector and subject matter expert for 0222.02

**Youngs, Rob**; SCL Inspector and subject matter expert for 0222.02

## Customer Requirements for Horizontal Directional Drilling (HDD)



### 1. Scope

This standard covers the customer requirements for horizontal directional drilling (HDD) installation of underground secondary single-phase and three-phase service conduit(s) in the right-of-way when required by franchise City or King County.

Underground secondary service in the Network system is outside the scope of this standard.

Primary service conduits are outside the scope of this standard.

### 2. Application

This standard is for customers, Seattle City Light (SCL) engineers, Electric Service Representatives (ESRs), Electric Service Engineers (ESEs), and contractors who design and/or construct underground secondary conduit installations using HDD means and methods.

Standard Coordinator  
Brett Hanson

Standards Engineering Supervisor  
John Shipek

Division Director  
Andrew Strong

### 3. Introduction

HDD is an underground excavation method using a steerable system for installing pipe, conduit, and cable using a surface-launched drill rig.

A fluid-filled pilot bore is drilled using a fluid-driven motor. The bore is then enlarged by pre-reaming when necessary, and by back-reaming to the size required for product pipe installation. The drill head steers the pilot boring.

Before drilling begins, the location, depth, and dimension of existing underground facilities within and near the proposed bore path are identified and located, including appurtenances as may exist, and the bore path alignment and profile through these underground facilities is planned. The location and depth of the drill head following this planned bore path is monitored and known at all times. Notifications and coordination with others whose underground facilities exist along the bore path are prearranged and timely.

---

### 4. Requirements

#### 4.1 General

All HDD installations shall be reviewed and approved by the SCL Distribution Engineer.

All HDD installations shall be performed by a licensed HDD contractor.

HDD shall meet the requirements listed in section 2-16 of the City of Seattle Standard Specifications for Road, Bridge and Municipal Construction, and all requirements listed in this standard. In case of conflict, the most stringent requirements will prevail.

#### 4.2 Submittal

Before any HDD activity starts, the contractor must create and submit the proposed bore path alignment shown on plan and profile shop drawings that meet the applicable requirements listed in SCL 0224.07. The contractor shall also determine all existing and known utility depths through all means available and include them on the shop drawings to show the appropriate clearances from SCL and non-SCL facilities as required by SCL 0214.00. The shop drawings with proposed bore path alignment shall be submitted to the SCL Distribution Engineer for review and approval.

#### 4.3 Materials

The conduit used shall be the SCL-approved material for HDD that is specified by SCL 7017.05 or SCL-approved zinc-coated steel conduit that is specified by SCL 7050.05.

The conduit size and number of conduits shall be specified by the SCL Distribution Engineer.

A minimum of two conduits are required for street crossings.

#### 4.4 Construction

All utility crossings shall be verified by pothole to confirm locates and required clearances. HDD conduits shall be terminated a minimum of three feet away from a handhole and terminated into the handhole using an open trench and conduit.

Four-inch and larger conduits shall be terminated a minimum of four feet away from the handhole.

#### 4.5 Damage Liability

Any utility infrastructure damaged as a result of HDD is the responsibility of the contractor.

#### 4.6 Inspection

The conduit material should be inspected prior to installation and the conduit shall be cleaned and mandreled after installation per SCL U2-11.40/NKD-40.

#### 4.7 As-Built Drawings

Upon completion of the conduit installation, the contractor shall submit an “as-built” drawing showing the depth of the installation along the alignment path to the SCL Distribution Engineer.

---

### 5. References

**SCL Construction Standard 0214.00**; “Clearances Between SCL Underground Structures and Other Structures”

**SCL Construction Standard 0224.07**; “Requirements for Secondary Conduit Installation”

**SCL Material Standard 7017.05**; “Directional Drilling Conduit Systems”

**SCL Material Standard 7050.05**; “Zinc-Coated Steel Conduit and Fittings”

**SCL Construction Standard U2-11.40/NDK-40**; “Mandreling and Cleaning of Ducts and Conduits”

**City of Seattle Standard Specifications for Road, Bridge, and Municipal Construction**; 2020 Edition

---

### 6. Sources

**Lu, Curtis**; SCL Standards Engineer and originator of 0223.03

**Knowlton, Christine**; SCL Civil Engineering Specialist Supervisor and subject matter expert for 0223.03

**Cast-in-Place Concrete Vault Collars**



**1. Scope**

This standard covers the requirements for cast-in-place concrete vault collars.

**2. Application**

Concrete collars are slabs of concrete installed around vault openings to prevent damage to the vault roofs, risers, and openings by vehicles.

Concrete collars are not required when the vault is installed below concrete pavement. In these cases, the vault openings must be secured to the concrete pavement to prevent the casting and frame from shifting.

**3. Requirements**

Concrete collars shall be installed around every vault opening, except where surrounding surface is concrete pavement. Collars shall be poured separately from any vault risers.

Collars shall be poured separately from any vault risers.

Vault openings shall be secured to the concrete collar or concrete pavement.

Concrete collars shall be a rectangular slab, 10 ft by 10 ft minimum, with a minimum thickness of 6 inches.

Collars shall be manufactured with Class 4000 concrete and shall meet the requirements of section 6-02 of the City of Seattle Standard Specifications.

Standard Coordinator  
Brett Hanson

Standards Engineering Supervisor  
John Shipek

Division Director  
Andrew Strong



Collars shall be centered on each vault opening and sized to provide 2 ft minimum of concrete from the edge of the opening to the edge of the collar.

Concrete shall have a broom finish perpendicular to the direction of traffic or match the roadway finish when installed in a concrete roadway.

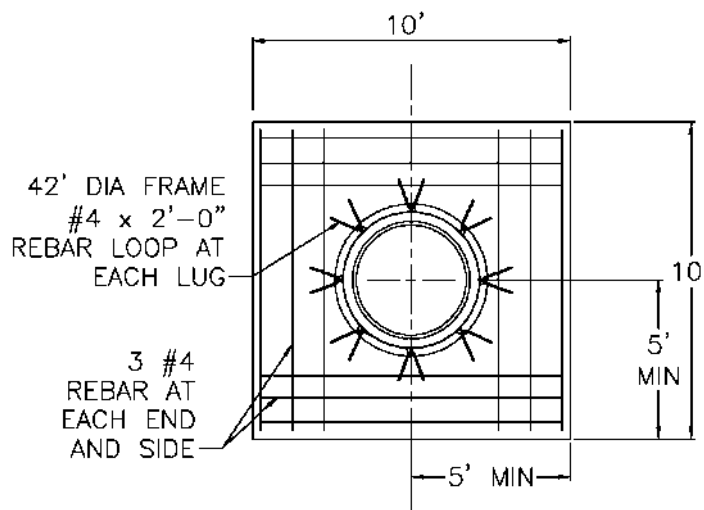
Opening frames shall be secured to the concrete collar or pavement with rebar hairpins. Rebar hairpins shall be #4, grade 60, 2 ft long minimum. See Figure 3a.

Examples of common collar and vault opening layouts are shown in figures 3b–3e.

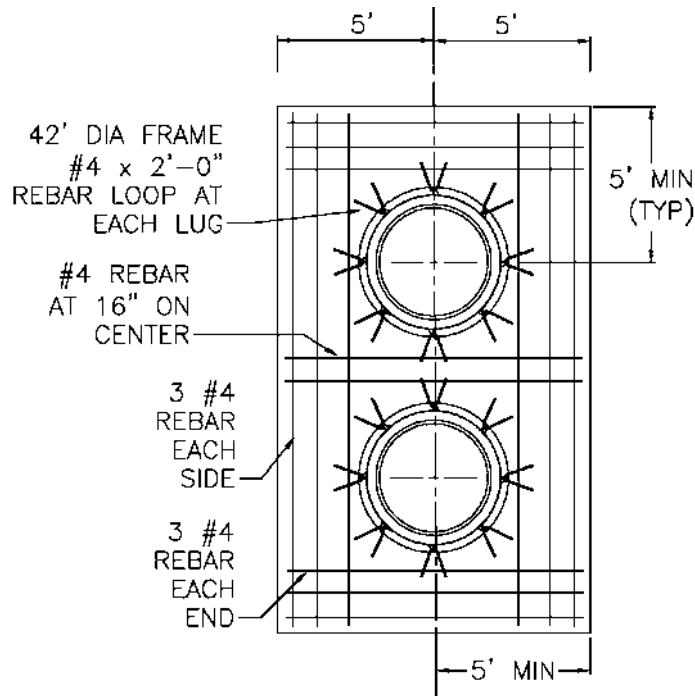
**Figure 3a. Rebar Hairpin Example**



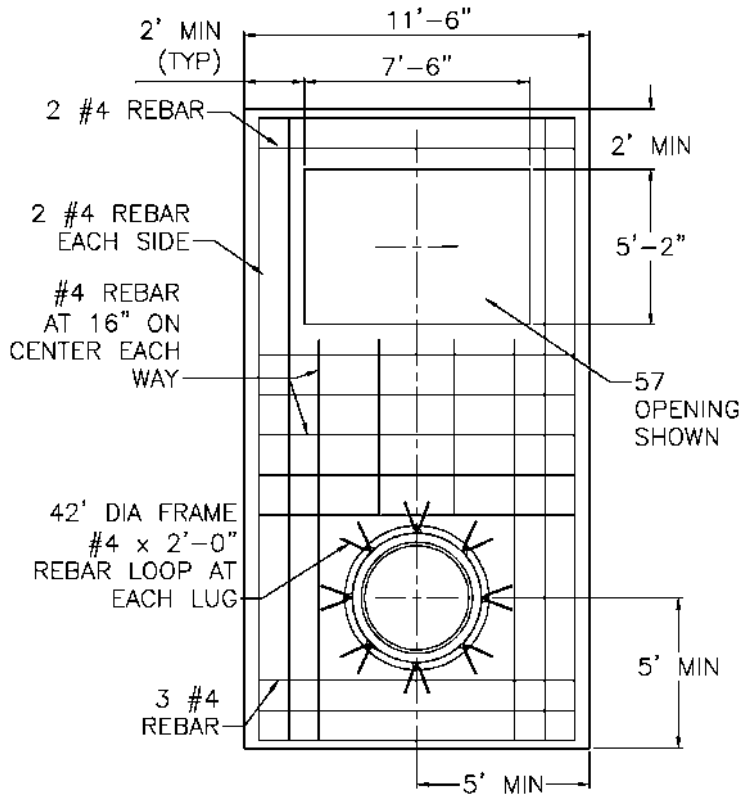
**Figure 3b. Single Round Access Example**



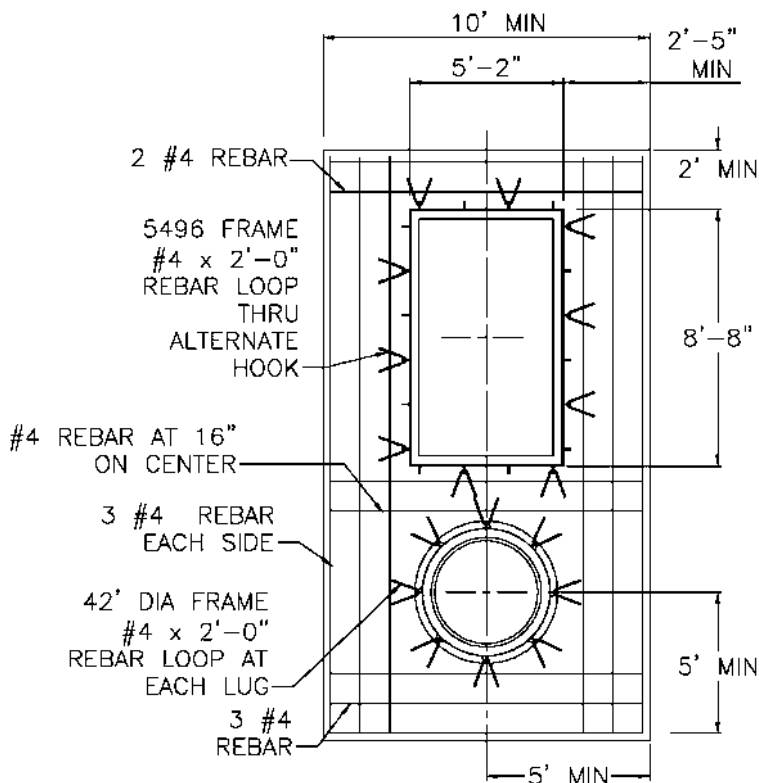
**Figure 3c. Two Round Accesses Example**



**Figure 3d. Round Access and Rectangular Hatch**



**Figure 3e. Round Access and 5496 Hatch**



**4. Sources**

**City of Seattle Standard Specifications for Road, Bridge, and Municipal Construction;** 2020 Edition

**Hanson, Brett;** SCL Standards Engineer, originator, and subject matter expert for 0223.33

**Ng, Sharon;** Senior Civil Engineer and subject matter expert for 0223.33

**SCL Material Standard 7203.81;** "Precast Reinforced Concrete Panel Vaults"

**SCL Material Standard 7204.15;** "Covers and Risers for Electric Vaults"

**SCL Material Standard 7204.70;** Frames and Covers, 42-Inch Round, Iron"

## Customer Requirements for Underground Secondary Service, Looped Radial System



### 1. Scope

This standard covers customer requirements for underground secondary services within the Seattle City Light (SCL) Looped Radial system.

An underground secondary service can be served from an overhead, pole-mounted transformer or an underground transformer located in the right-of-way. The service point is determined by SCL.

Underground secondary service in the Network system is outside the scope of this standard.

Primary service is outside the scope of this standard.

SCL shall determine whether the service design will be primary or secondary.

A service where the customer must provide a facility on private property for SCL transformers is outside the scope of this standard.

### 2. Application

This standard is intended for use by customers and SCL engineering, electric service representatives, and operations personnel.

This standard provides a reference to SCL standards that specify customer requirements for underground secondary service in the looped radial system.

Standard Coordinator  
Brett Hanson

Standards Engineering Supervisor  
John Shippek

Unit Director  
Andrew Strong

### 3. Inspection

The following items must be inspected by SCL before cover is installed:

- Conduit trench
- Trench bedding
- Conduit
- Trench backfill
- Handhole bedding
- Handholes

Inspection points shall be adhered to for all installation projects. Inspection points are put in place to ensure conformity to SCL requirements. Failure of the customer to request an inspection may result in additional requirements.

---

### 4. Conflict

Where conflict exists between SCL requirements, the following order of precedence shall apply:

1. Project-specific Customer Requirements Package, including the Service Construction Drawing
2. SCL 0224.01
3. Other SCL standards

---

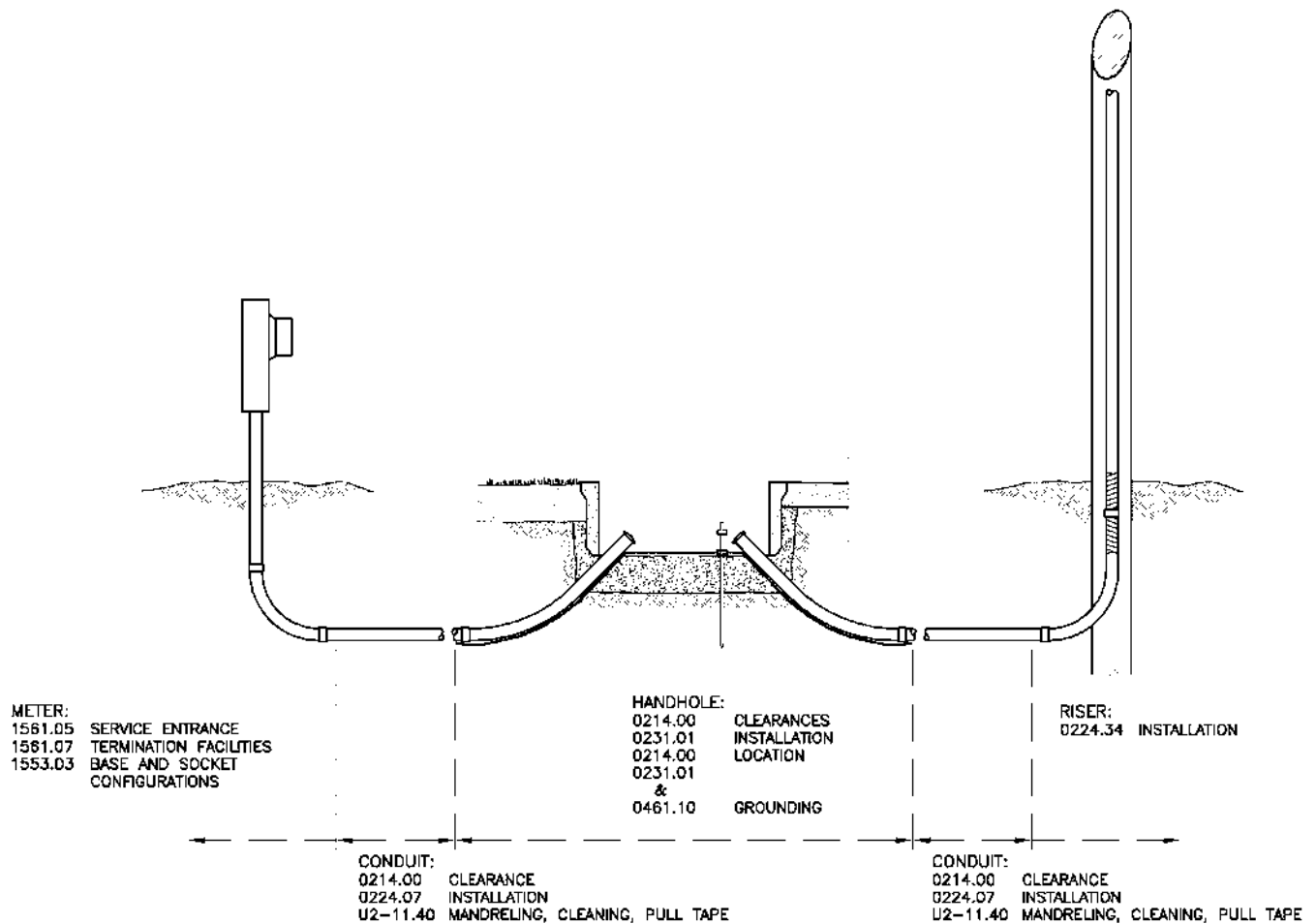
### 5. Requirements

Customer is responsible for obtaining municipal permit before trenching in the right-of-way.

It is the customer's responsibility to locate all underground utilities before excavating. Customer should call 811 at least two business days before the planned excavation date.

Customer-owned cable shall comply with the electrical code enforced by the Authority Having Jurisdiction (AHJ) and shall be visibly marked at the point of termination (service point) to indicate phase and service being fed.

**Figure 5. Guide to Underground Secondary Service Standards**



## 6. References

- Requirements for Electrical Service Connection (RESC);** Seattle City Light
- SCL Construction Standard 1553.03;** “Meter Base and Socket Configurations”
- SCL Construction Standard 0214.00;** “Clearance between SCL Underground Structures and Other Utility Structures in the Public Right-of-Way”
- SCL Construction Standard 0224.07;** “Requirements for Secondary Conduit Installation”
- SCL Construction Standard 0224.34;** “Steel Conduit Risers”
- SCL Construction Standard 0231.01;** “Secondary Handhole Installation”
- SCL Construction Standard 0461.10;** “Grounding Electrodes for Handholes and Vaults”
- SCL Construction Standard 1561.05;** “Customer Requirements for Underground Single or Dual Meters, Residential Service”
- SCL Construction Standard 1561.07;** “Customer Requirements for Underground Secondary Service Termination Facilities”

**SCL Construction Standard U2-11.40/NDK-40;** “Mandreling and Cleaning of Ducts and Conduits”

**SCL Construction Standard U2-14.2;** “Vault Installation”

---

## 7. Sources

**Chao, Yaochiem;** SCL Standards Engineer, originator, and subject matter expert for 0224.01

**Hanowell, Manny;** SCL North Distribution Engineer and subject matter expert for 0224.01

**Panomvana, Tanya;** SCL North Distribution Engineer and subject matter expert for 0224.01

**Perander, Eivind;** SCL North Distribution Supervisor and subject matter expert for 0224.01

## Requirements for Secondary Conduit Installation



### 1. Scope

This standard provides the general requirements for the construction and installation of secondary conduits within the Seattle City Light (SCL) service territory. This standard also applies to conduits within SCL easement areas.

Job-specific requirements are not covered in this standard. Refer to the SCL Requirements Letter for job-specific requirements.

### 2. Application

This standard provides direction to SCL crews, contractors, and customers about where and how to properly install secondary (0–600 V) conduits in the right-of-way and on private property.

For primary (601 V–50,000 V) conduit and duct bank installation, see SCL 0222.02.

Conduits installed in SCL easements shall meet the requirements of conduits in the right-of-way.

For clearances to other underground structures and utilities, see SCL 0214.00.

Standard Coordinator  
Brett Hanson

Standards Engineering Supervisor  
John Shipek

Unit Director  
Andrew Strong



### 3. Conflict

Where conflict exists between SCL requirements, the following order of precedence shall apply:

1. Project-specific Customer Requirements Package, including Service Construction Drawing
2. SCL 0224.07
3. Other SCL standards

### 4. Requirements

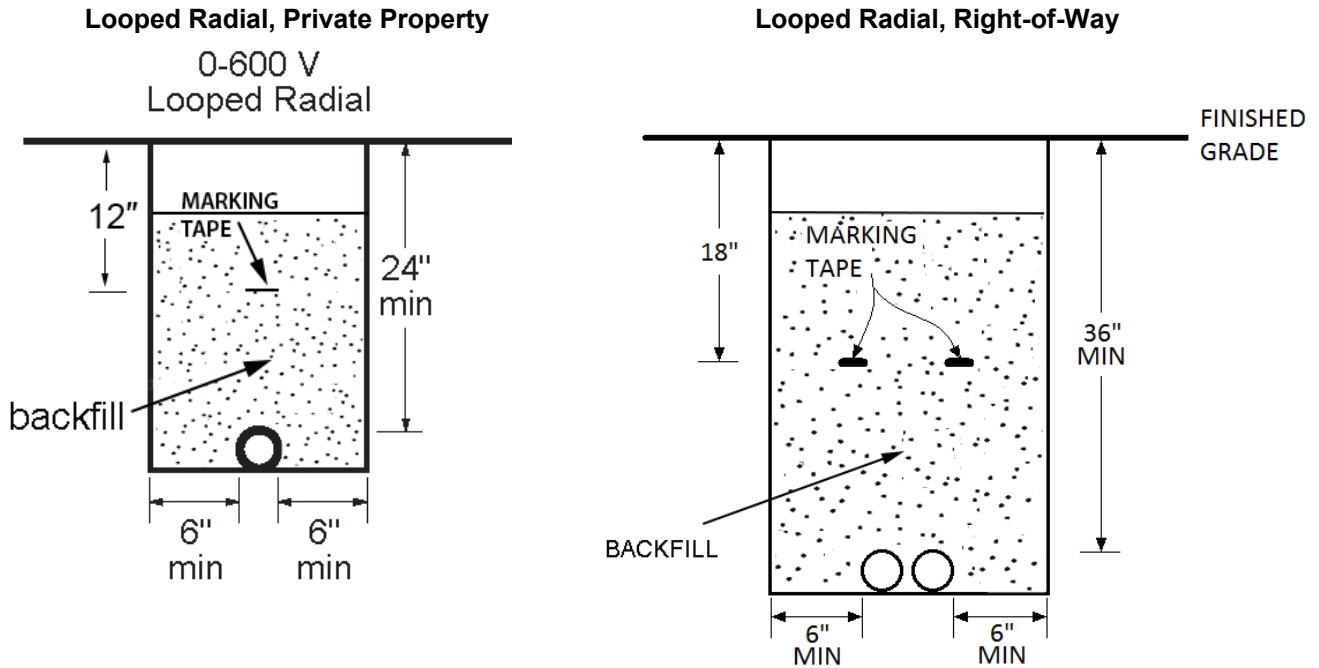
General requirements are shown in Table 4 and Figures 4a and 4b.

**Table 4. General Requirements**

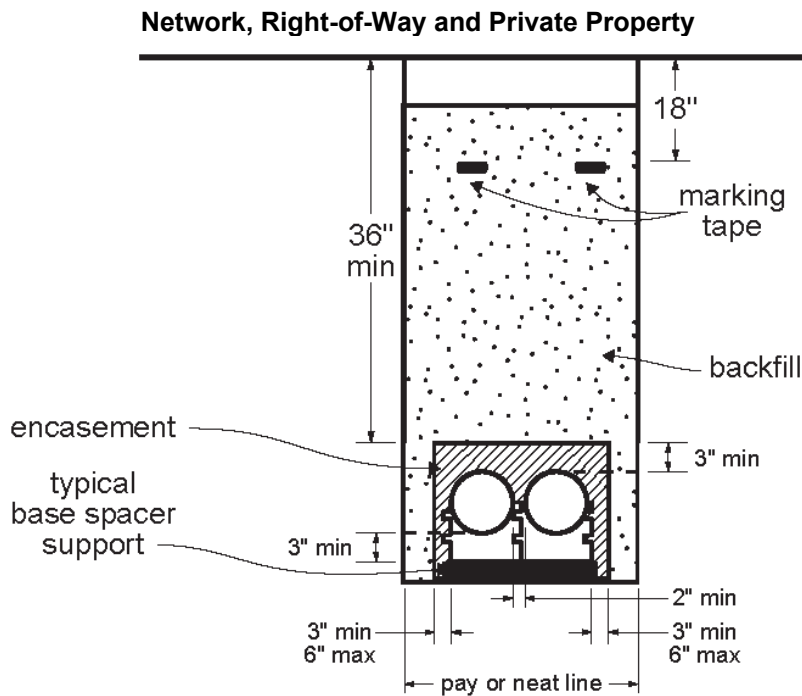
Location	Right-of-Way		Private Property	
	Network	Looped Radial	Network	Looped Radial
Area	Network	Looped Radial	Network	Looped Radial
Voltage	0–600 V	0–600 V	0–600 V	0–600 V
Function	System or Service	System or Service	System or Service	System or Service
Cover (minimum)	36 in	36 in	36 in	24 in
No. of conduits (minimum)	2	1 <sup>a</sup>	2	1
Encasement	Yes for 4" and larger	No	Yes for 4" and larger	No
Marking tape	Yes	Yes	Yes	Yes
Backfill to sub-grade	CDF	CDF	CDF	Native soil

<sup>a</sup> A minimum of two conduits are required for street crossings.

**Figure 4a. General Requirements, Looped Radial Conduits**



**Figure 4b. General Requirements, Network Conduits**



For Network conduits, runs shall not exceed 180 degrees of bends between pulling access points, including riser bends under the termination point and at the pole.

For Looped Radial conduits, runs shall not exceed 270 degrees of bends between pulling access points, including riser bends under the termination point and at the pole

A pulling handhole may be necessary to reduce the total length of service conduit between pulling access points to 150 ft.

## 5. Location/Clearances

Secondary conduits shall be installed in locations specified by the SCL engineer.

Cover from the top of the conduit or encasement to grade is required. See Table 4.

For clearances to non-SCL facilities, conduits, and pipes, see SCL 0214.00.

## 6. Conduit

Conduit shall be SCL-approved material specified for direct burial.

Conduit size and number of conduits are specified by the SCL engineer.

Conduits shall be mandreled and cleaned per SCL U2-11.40/NDK-40.

Factory and field straight-cut ends shall be chamfered throughout the duct run.

Conduits can be used as specified in Table 6a.

All Network conduits 4 inches and larger shall be encased. See SCL 0222.02 for encasement details.

If four or more conduits are required, install duct bank per SCL 0222.02.

If any conduits in a duct bank require encasement, all conduits shall be encased.

Set screw couplings are only permitted when installed in an encased duct bank.

**Table 6a. Allowed Conduit Materials**

	<b>Schedule 40 PVC (SCL 7015.05)</b>	<b>Rigid Steel (RGS) (SCL 7050.05)</b>	<b>Schedule 80 PVC (SCL 7020.05)</b>
Straight	Yes	Yes	Yes <sup>a</sup>
Bend	No	Yes	Yes <sup>a</sup>

<sup>a</sup> Network only, for conduits smaller than 4 inches.

**Table 6b. Minimum Bend Radius**

<b>Conduit (in)</b>	<b>Minimum Bend Radius (in)</b>
3	36
4	48
5	60

Note: Bending PVC conduits with heat is not allowed.

### 6.1 New Conduit Termination

For termination of new conduit into a handhole, see SCL 0231.01.

For termination of new conduit into a conduit riser, see SCL 0224.34.

Conduits shall enter vaults perpendicular to the vault wall no more than 18 inches from the adjacent wall to the farthest edge of the conduit.

### 6.2 Existing Conduit Termination

For termination of existing conduit into a new handhole or vault, see U2-11.3/NDK-30.

---

## 7. Trench

The trench shall be excavated with a minimum spacing of 6 inches from the conduit to the closest trench wall.

The bottom of the trench shall be free of debris and fine-graded by hand to remove sharp, embedded rocks and loose stones over 1/2 inches in size. Or, the trench shall be over-excavated and replaced with bedding material to cover protruding rocks and stones by a minimum of 2 inches. The bottom shall be graded even. Bedding material shall be sand.

---

## 8. Spacers for Encased Conduit

Spacers for conduit separation shall be plastic lock-type (see SCL 7015.80) of such configuration to give the required separation between conduit and earth, as shown in Figure 4b.

Horizontally, spacers shall be placed a maximum of 5 ft apart in both straight and bending sections of duct banks and a minimum of one foot away from any coupling, fitting or end bell.

Base spacers shall be used to obtain clearance to subgrade material under the conduit for the placement of the 3-in minimum of encasement.

Base spacers may also be used to obtain 3-in side cover of conduit in bends.

Two-inch nominal concrete blocking, 16-in by 8-in by 1.75-in minimum, shall be provided under the base spacers.

Secure conduit to spacers in order to prevent flotation and deflection during encasing.

---

## 9. Backfill

For backfill material requirements, See Table 4.

---

## 10. Identification

Install two, 3-in-wide, red detectable underground marking tapes over the conduits. See Table 4 and Figures 4a and 4b.

---

## 11. Transition

A proper transition is required when transitioning conduits onto private property from conduits in the right-of-way. See SCL 0222.02 for requirements on changes in direction.

## 12. Inspection

The following items must be inspected by SCL before backfill is installed:

- Conduit trench
- Trench bedding
- Proper conduit installation and adherence to engineering design and SCL standards
- Trench backfill material

After backfill inspection, mandreling shall be performed per U2-11.40 with an Electrical Reviewer. SCL will provide the mandrel.

Inspection points shall be adhered to for all installation projects. Inspection points are put in place to ensure conformity to SCL requirements. Failure of the customer to request an inspection may result in additional requirements. See SCL 0222.02 Section 5 for conduit details. See SCL U2-11.40/NDK-40 for mandreling and cleaning details.

---

## 13. References

**SCL Construction Standard 0214.00**; “Clearances between SCL Underground Structures and Other Utility Structures in the Public Right-Of-Way”

**SCL Construction Standard 0222.02**; “Requirements for Primary Conduit and Duct Bank Installation”

**SCL Construction Standard 0224.34**; “Steel Conduit Risers”

**SCL Construction Standard 0231.01**; “Secondary Handhole Installation and Grounding”

**U2-11.3/NDK-30**; “Termination Of Existing Ducts in New Vaults or Manholes”

**SCL Construction Standard U2-11.40 /NDK-40**; “Mandreling and Cleaning of Ducts and Conduits”

**SCL Material Standard 7015.05**; “Schedule 40 PVC Conduit and Fittings”

**SCL Material Standard 7015.80**; “Conduit Spacers for PVC and FG Conduit”

**SCL Material Standard 7020.05**; “Schedule 80 PVC Conduit and Elbows”

**SCL Material Standard 7050.05**; “Zinc-Coated Steel Conduit and Fittings”

---

## 14. Sources

**Abbott, Jeremy**; SCL Electrical Reviewer and subject matter expert for 0224.07

**Chao, Yaochiam**; SCL Standards Engineer, originator, and subject matter expert for 0224.07

**Edwards, Tommy**; SCL Electrical Reviewer and subject matter expert for 0224.07

**Perander, Eivind**; SCL North Distribution Supervisor and subject matter expert for 0224.07

**SCL 0224.05** (canceled); “Requirements for Underground Services on Private Property”

**Steel Conduit Risers****1. Scope**

This standard covers the installation of primary and secondary steel conduit riser assemblies on Seattle City Light (SCL) distribution system wood poles. Instructions for installing the riser to the pole are included, along with requirements for spacing and hardware.

Riser extensions are covered in SCL 0126.04.

Primary pole terminations are covered in SCL 0126.01.

Streetlight pole terminations are covered in SCL 1714.50.

Composite, steel, laminated, and other non-wood poles are outside the scope of this standard.

**2. Application**

This standard provides direction to SCL engineers, crews and contractors who specify or install steel conduit risers on SCL distribution system wood poles.

**3. Requirements****3.1 General**

Only one set of conduit risers (primary, secondary, communications) on a standoff bracket shall be allowed per pole, as shown in figures 3.1a, 3.1b, and 3.3.

All SCL risers and bends shall be rigid steel. See SCL 7050.05. Non-SCL communication conduit risers can be PVC.

All conduit risers originating from the direction of the face of the pole shall be constructed as shown in Figure 3.1a and 3.1b. The face of the pole is the side of the pole where the brand, gain notch, and date nail with the last two digits of the installation year are located. It is typically the side of the pole where the equipment (transformers, switches, and conduits) are attached to a pole.

All conduit risers originating from the back and around the pole shall be constructed as shown in Figure 3.1b, 3.1c and 3.1d.

Two, three, and five inch, 22.5-degree steel bends are bent in the field. Additional straight sections have been provided for field bending.

For primary risers, below-grade conduits shall be encased and constructed as shown in SCL 0222.02. The encasement shall end before the elbow.

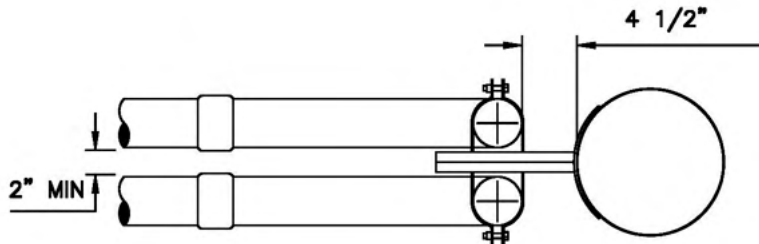
For secondary risers, below-grade conduits shall be constructed as shown in SCL 0224.07 for conduits in private property and for conduits in the right-of-way or SCL easement areas.



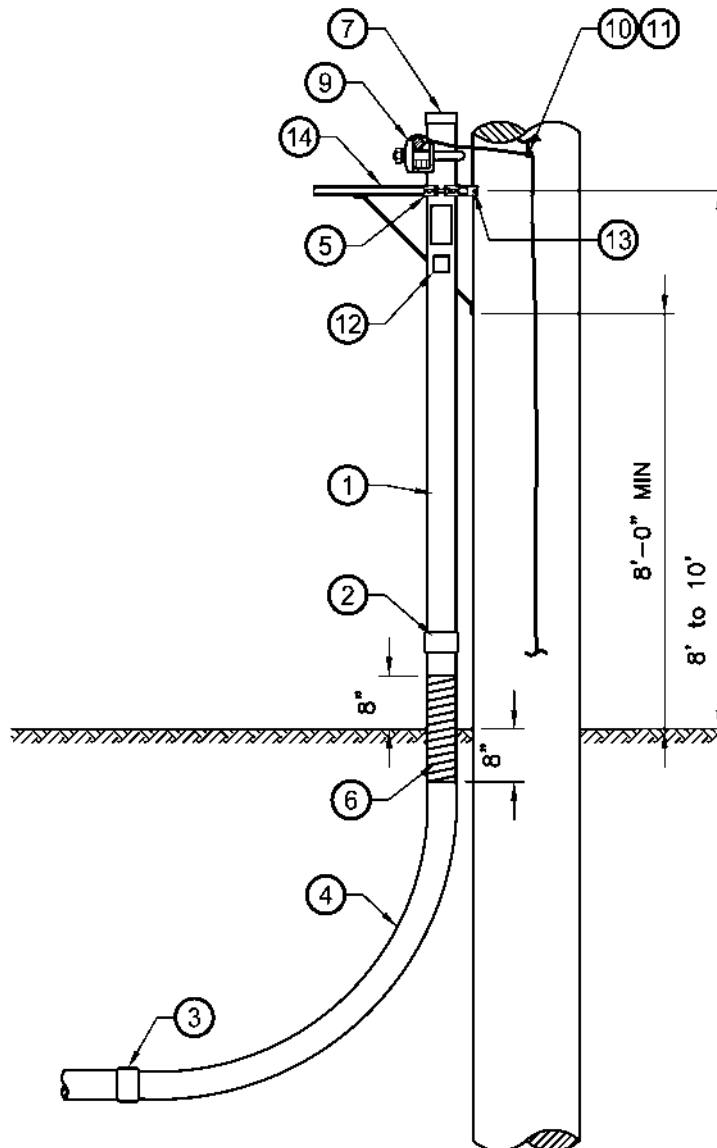


A single one-inch non-SCL riser can be installed on the surface of the pole. The conduit shall be in the quadrant between the roadside and the face of the pole, as shown in Figure 3.3. Conduit straps shall be installed, at a minimum, every 5 feet.

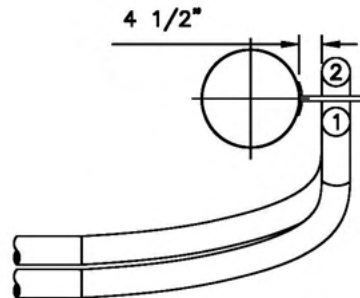
**Figure 3.1a. Steel Conduit Riser, Top View**



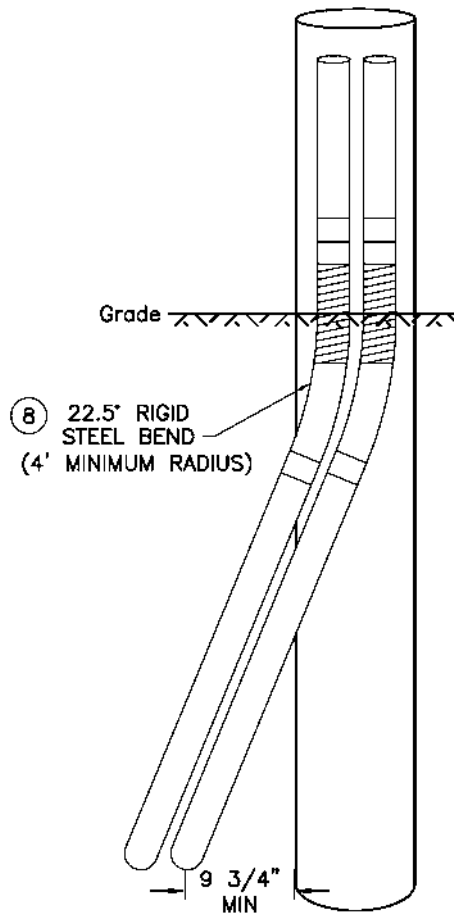
**Figure 3.1b. Steel Conduit Riser, Side View**



**Figure 3.1c. Wraparound Steel Conduit Riser, Top View**



**Figure 3.1d. Wraparound Steel Conduit Riser, Profile View**



### 3.2 Backfill

Backfill around the pole shall be Controlled Density Fill (CDF) trench backfill per SCL 0226.11 and the Seattle Standard Specifications.



### 3.3 Orientation and Arrangement

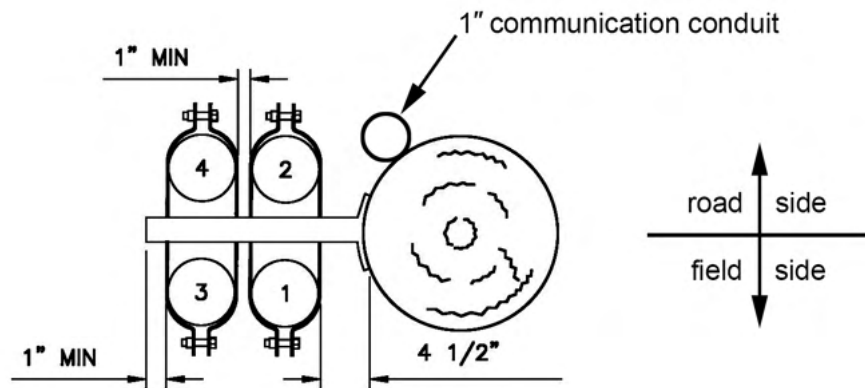
The first ten feet of conduit above grade shall be attached to a bracket that is installed on the face of the pole. If there is more than one conduit, arrange the highest voltage conduit closest to the pole while attaching to alternating sides of the bracket as shown in Figure 3.3.

The closest SCL riser conduit shall be 4.5 inches away from the face of the pole. Each additional riser conduit installed shall be 1 inch from the conduit next to it.

The closest non-SCL riser conduit shall be no less than 10 inches from the face of the pole.

Each conduit shall be attached to the bracket with a strap. If there are wraparound conduit risers and standard risers, the wraparound riser shall be located closer to the pole.

**Figure 3.3. Orientation and Arrangement of Riser Conduits**



### 3.4 Bracket

One riser bracket (see SCL 6867.50) shall be used per above grade conduit section. The maximum riser bracket length shall be 26 inches. If a 5-in conduit is being installed, a 26-in bracket shall be used.

The lowest point of the lowest bracket on the pole shall be located a minimum of 8 feet above grade.

The lowest bracket on a pole shall be a braced bracket.

If a bracket exists and has enough space, add conduits to it. If there is not enough space, replace with a larger bracket. Contact a SCL engineer if there are more than 4 conduits on a bracket.

### 3.5 Grounding

A ground clamp (see SCL 6762.7) shall be installed below the top of the steel conduit and above the riser bracket as shown in Figure 3.1b.

The clamp shall be connected to the pole ground using #4 AWG solid copper wire.

When more than one steel conduit is installed, use one continuous piece of copper wire between ground clamp bushings and connect once to the pole ground.

Final connection to pole ground shall be performed by the SCL overhead crew. Materials are listed in Table 5b.

A ground clamp shall be installed below grade when required by SCL 0461.10.

### 3.6 Identification

A label identifying the facility and the originating facility shall be affixed to the riser directly below the conduit strap on the side facing away from the bracket.

A call before you dig sticker shall also be affixed directly below the facility label at no lower than 5 feet above grade.

Identification is installed by the SCL underground crew. Materials are listed in Table 5c.

### 3.7 Installation

PVC pipe wrap shall be wrapped around the conduit starting 8 inches below the ground level to 8 inches above the ground level.

An end cap shall be installed on all spare conduits.

All conduit located above grade shall be vertical.

---

## 4. Construction Notes

The pole shall be temporarily guyed or braced before excavation is made at the base of the pole.

Remove all temporary brackets and braces located below 8 feet prior to backfilling.

**5. Material Lists**

**Table 5a. Materials for Steel Conduit Riser Assemblies**

Fig	Compatible Unit	ID	Quantity			
3.1b	Riser, 2" assembly	DRGS-RISER2				
3.1b	Riser, 3" assembly	DRGS-RISER3				
3.1b	Riser, 4" assembly	DRGS-RISER4				
3.1b	Riser, 5" assembly	DRGS-RISER5				
#	Material Description	ID				
1	Conduit, rigid steel, 2"	734741	-	-	-	20
1	Conduit, rigid steel, 3"	734743	-	-	20	-
1	Conduit, rigid steel, 4"	734745	-	20	-	-
1	Conduit, rigid steel, 5"	734747	20	-	-	-
2	Coupling, rigid steel conduit, 2"	731096	-	-	-	1
2	Coupling, rigid steel conduit, 3"	731098	-	-	1	-
2	Coupling, rigid steel conduit, 4"	731100	-	1	-	-
2	Coupling, rigid steel conduit, 5"	731102	1	-	-	-
3	Conduit adapter, PVC to steel 2"	734544	-	-	-	1
3	Conduit adapter, PVC to steel 3"	734537	-	-	1	-
3	Conduit adapter, PVC to steel 4"	734539	-	1	-	-
3	Conduit adapter, FG to steel 5"	TBD	1	-	-	-
4	Elbow, rigid steel, 2"	734820	-	-	-	1
4	Elbow, rigid steel, 3"	734822	-	-	1	-
4	Elbow, rigid steel, 4"	012176	-	1	-	-
4	Elbow, rigid steel, 5"	734826	1	-	-	-
5	Strap, strut pipe/conduit, 2"	689764	-	-	-	1
5	Strap, strut pipe/conduit, 3"	689768	-	-	1	-
5	Strap, strut pipe/conduit, 4"	689772	-	1	-	-
5	Strap, strut pipe/conduit, 5"	689774	1	-	-	-
6	Tape, pipe wrap, PVC, 2" x 10 mil (roll)	736730	1	1	1	1
7	Plug, PVC, 2"	734938	-	-	-	1
7	Plug, PVC, 3"	734940	-	-	1	-
7	Plug, PVC, 4"	734942	-	1	-	-
7	Plug, PVC, 5"	734943	1	-	-	-
8	Conduit, rigid steel, 22.5°	013749	-	1	-	-
13	Bolt, lag, 1/2" x 4"	785261	3	3	3	3
14	Bracket, pole riser, w/ brace, 18"	686796	1	1	1	1

**Table 5b. Steel Riser Grounding**

Fig	Compatible Unit	ID	Quantity			
3.1b	2" Steel riser ground	GRND-RISER2				
3.1b	3" Steel riser ground	GRND-RISER3				
3.1b	4" Steel riser ground	GRND-RISER4				
3.1b	5" Steel riser ground	GRND-RISER5				
#	Material Description	ID				
9	Clamp, conduit grounding 2"	676283	-	-	-	1
9	Clamp, conduit grounding 3"	676285	-	-	1	-
9	Clamp, conduit grounding 4"	676286	-	1	-	-
9	Clamp, conduit grounding 5"	676287	1	-	-	-
10	Connector, vise jaw #4 AWG	012173	1	1	1	1
11	Wire, #4 AWG, Cu soft drawn	610208	3	3	3	3

**Table 5c. Steel Riser Labeling**

#	Material Description	ID	Quantity
12	"Call Before You Dig" label	765255	1

**6. References**

- City of Seattle Standard Plans** for Municipal Construction, 2020 Edition
- City of Seattle Standard Specifications** for Road, Bridge, and Municipal Construction, 2020 Edition
- SCL Construction Standard 0126.01**; "Primary Pole Terminations"
- SCL Construction Standard 0126.04**; "Riser Extensions"
- SCL Construction Standard 0222.02**; "Requirements for Duct Banks in the Public Right-of-Way"
- SCL Construction Standard 0224.07**; "Requirements for Secondary Conduit Installation"
- SCL Construction 0226.11**; "Backfill Operations, General Requirements"
- SCL Construction Standard 0461.10**; "Grounding Electrodes for Handholes and Vaults"
- SCL Construction Standard 1714.50**; "Underground Streetlight Systems"
- SCL Material Standard 6762.7**; "Ground Clamps Parallel or Transverse Cable Connection(s) to Rod or Pipe"
- SCL Material Standard 6867.50**; "Bracket, For Pole Riser Conduit"
- SCL Material Standard 7050.05**; "Zinc-Coated Steel Conduit and Fittings"

## 7. Sources

**Chao, Yaochiem**; SCL Standards Engineer and subject matter expert for 0224.34

**Hall, Alan**; SCL Electrical Engineer and subject matter expert for 0224.34

**Lu, Curtis**; SCL Standards Engineer and originator of 0224.34 (curtis.lu@seattle.gov)

**SCL Construction Standard U7-10/NDK-70** (canceled); "Conduit Risers on Poles"

**SCL Construction Standard U7-10.1/NDK-80** (canceled); "Secondary Conduit Riser Pole Base Detail"

**SCL Construction Standard U7-10.2/NDK-90** (canceled); "Primary Conduit Riser Pole Base Detail"

**SCL Construction Standard U7-10.9/NDK-120** (canceled); "Grounding Conduit Risers on Poles"

## Installation of Fluidized Thermal Backfill



---

### 1. Scope

This standard covers the mix, field, and testing requirements for the installation of Fluidized Thermal Backfill (FTB).

---

### 2. Application

This standard is intended to be used by Seattle City Light (SCL) crews, inspectors, reviewers, contractors, and customers when installation of FTB is specified.

---

### 3. Industry Standards

Construction shall meet the applicable Requirements of the latest revision of the following industry standards:

**ASTM C31**; “Standard Practice for Making and Curing Concrete Test Specimens in the Field”

**ASTM C39**; “Standard Test Method for Compressive Strength of Cylindrical Concrete Specimens”

**ASTM C94**; “Standard Specification for Ready-Mixed Concrete”

**ASTM C143**; “Standard Test Method for Slump of Hydraulic-Cement Concrete”

**ASTM 172**; “Standard Practice for Sampling Freshly Mixed Concrete”

---

Standard Coordinator  
Brett Hanson

Standards Engineering Supervisor  
John Shipek

Unit Director  
Andrew Strong

---

**City of Seattle; “Standard Specifications for Road, Bridge and Municipal Construction,”** (henceforth referred to as the “Standard Specifications”), latest revision  
**IEEE Standard 442; “IEEE Guide for Soil Thermal Resistivity Measurements”**

---

#### **4. Mix Requirements**

##### **4.1 Mix Design**

Prior to placement, the contractor shall submit to SCL the proposed FTB mix design for approval. The mix design shall conform to SCL 7150.00, “Fluidized Thermal Backfill.”

##### **4.2 Conformance to Mix Design**

Quantities of batched component materials shall match those specified in the FTB mix design within the tolerances specified in Section 6-02.3(5)C (“Conformance To Mix Design”) of the Standard Specifications.

---

#### **5. Field Requirements**

##### **5.1 Delivery Certificate**

The FTB supplier shall provide a Manufacturer’s Certificate of Compliance for each truckload of FTB per Section 6-02.3(5)B (“Certification Of Compliance”) of the Standard Specifications. The Certificate shall include the following information:

- Identification code
- Delivery location
- Quantity of water added to mix after batching

##### **5.2 Delivery Time Limit and Temperature**

The time for placement and temperature shall conform to Section 6-02.3(4)D (“Temperature and Time for Placement”) of the Standard Specifications.

##### **5.3 Retempering**

Retempering is prohibited.

##### **5.4 FTB Placement**

FTB shall be placed per the applicable provisions of Section 6-02.3(6) (“Placing Concrete”) of the Standard Specifications.

If the concrete is to drop more than 5 ft, it shall be deposited through a sheet metal (or other approved material) conduit. No aluminum conduits or tremies shall be used to pump or place concrete.

FTB shall flow readily and fill all voids during installation. Formation of air pockets during installation shall be cause for rejection.

Conduits to be encased in FTB shall be adequately anchored so that they do not float during FTB placement. The water content of FTB may not be reduced to mitigate conduit buoyancy.

##### **5.5 Vibration**

Should vibration be required to ensure that the conduits are fully encased in FTB, it shall be in conformance with Section 6-02.3(9) (“Vibration of Concrete”) of the Standard Specifications.

## 6. Testing Requirements

For SCL power system construction projects that require more than 100 cubic yards of any combination of FTB materials, the project manager shall provide an FTB thermal test and FTB compressive strength test for each FTB mix design employed by the project.

The testing shall be done at the beginning of FTB placement for that project. Both thermal and compressive strength samples shall be drawn from the same batch of FTB. Test results shall be submitted to SCL for review.

Where thermal and compressive strength testing is done on the same batch of FTB, the samples shall have identical sample locations or other matching sample identification codes, assigned to both sets. The purpose is correlation of test data.

Field test parameters shall apply to field approvals of FTB encasement and backfill where required.

The thermal resistivity requirement will be evaluated by comparing the FTB thermal test report specified in section 6.2 to the resistivity benchmarks from SCL 7150.00.

### 6.1 Sampling

Sampling shall be in conformance with ASTM C172.

Sample containers shall be cylindrical, 3 inches in diameter and 6 inches tall. A set of three sample containers are required for each thermal test. The sample containers shall be prepared per ASTM C94, and sealed to prevent moisture loss.

Each sample container shall receive a label with the following information:

- Date of sample
- Location where sampled FTB was installed. The description of the location should be detailed enough to determine which duct bank, or portion thereof, was sampled.
- Project name and the SCL Work Order number, if known
- Type of FTB (high-strength or low-strength)
- FTB Producer
- FTB Producer's Mix Design number
- Name of the SCL Inspector, SCL Crew Chief, or person responsible for sampling

The concrete delivery ticket and batching compliance report shall be included with each set of samples. Only legible copies are acceptable.

The samples shall cure 24 hours prior to shipping. The samples shall be shipped in a cardboard box with adequate packing materials to prevent damage during shipping. The samples shall be shipped to an SCL-approved consultant for thermal testing.

### 6.2 Thermal Testing

Seattle City Light uses thermal testing results to assess FTB performance and to investigate FTB-related issues. FTB documentation shall be adequate to trace the source of each aggregate and the source of fluidizer material for each batch of FTB installed. Failure to systematically identify sources of materials shall be cause for rejection and disqualification.

Thermal testing shall be conducted in compliance with IEEE Standard 442.



The testing consultant shall provide a complete copy of the test report to SCL that includes:

- Name and contact information of the thermal testing consultant
- Report date
- Concrete delivery ticket number
- FTB Producer
- FTB Producer's Mix Design No.
- Dry density of each sample set, in pounds/cubic foot
- Thermal resistivity of each sample set (°C-centimeter/watt)

### 6.3 Strength Testing

Strength testing for high-strength FTB shall be performed in compliance with ASTM C39. A complete copy of the test report shall be provided to Seattle City Light.

Sampling shall be performed in compliance with ASTM C31, and the samples shall be labeled as described in the Thermal Testing Procedure.

### 6.4 Field Testing

When field testing is required, thermal testing shall be done by an SCL-approved consultant in compliance with IEEE Standard 442.

A field slump test shall be performed on each batch. The slump test shall conform to ASTM C143 and meet the performance values listed in Table 4 of SCL 7150.00.

One test is required per project or location. Additional testing is required when requested by SCL personnel. The test report shall contain the information specified in sections 6.2 and 6.3.

---

## 7. Remedies for Installation of Unapproved FTB Mixes

Installation of an FTB mix, where specified, that has not been approved by Seattle City Light requires one of the following remedies:

- Removal and replacement of all noncompliant FTB with a Seattle City Light-approved mix.
- In-field thermal testing of all non-compliant FTB. Any unapproved FTB that does not meet the FTB Mix Design Requirements shall be removed and replaced with a Seattle City Light-approved mix.

---

## 8. References

**SCL Material Standard 7150.00**, "Fluidized Thermal Backfill"

**SCL Design Standard 9266.06**, "Understanding Fluidized Thermal Backfill"

---

## 9. Sources

**Lu, Curtis**; SCL Standards Engineer, and originator and subject matter expert for 0226.06

**Stewart, Bob**; SCL Civil Inspector and subject matter expert for 0226.06

## Requirements for Pad Mounted Termination Enclosure Installations

### 1. Scope

This standard covers the requirements for the installation of a pad mounted termination enclosure. A pad mounted terminal enclosure is an option that may be used when any of the following conditions apply:

- The number of customer secondary cables exceeds the termination positions of the transformer.
- The number of customer secondary cables exceeds the terminating capacity of the 1000 A or 2000 A multiple connectors.
- The pad mounted terminal enclosure reduces the footprint of the secondary termination facility.
- The customer's electrical switchgear is located at a lower elevation than the transformer and may allow for water intrusion.

### 2. Application

This standard provides direction to Seattle City Light (SCL) engineers, crews, reviewers and customers for the minimum requirements for a pad mounted termination enclosure. These requirements ensure that the enclosure can be used as an approved termination facility.

### 3. Requirements

The installation of the enclosure, secondary conductors, and any civil work are performed by the customer. SCL will only pull and terminate the utility secondary cable(s) from the transformer.

#### 3.1 Enclosure

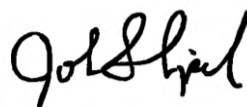
The enclosure being installed:

- Shall be UL Listed.
- Shall be NEMA 3R rated.
- Shall have lockable door(s). Doors may also be located on the back of the enclosure.
- Shall be mounted on a 4" to 6" tall concrete pad or pedestal.
- No mullion is allowed between the doors. The doors shall meet up when shut, such that they are lockable with only one utility padlock.
- If the back of the enclosure is removable, the back shall be removable only after gaining access through the front door(s).
- Shall be between 5 feet and 7 feet in height.

Standards Coordinator  
Curtis Lu



Standards Supervisor  
John Shipek



Unit Director  
Andrew Strong



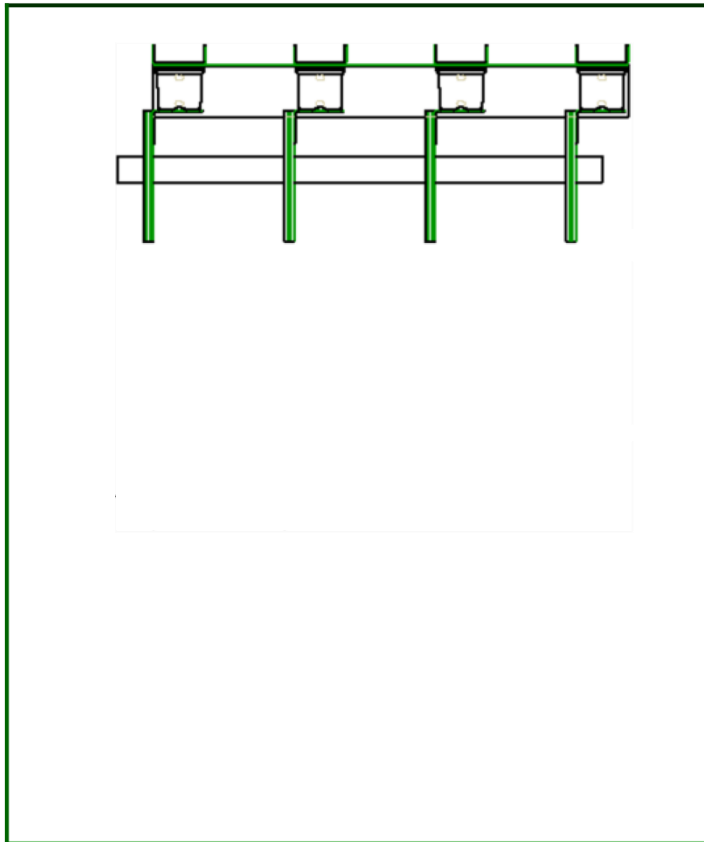
### 3.2 Bus Bars

Bus bars shall be drilled per SCL 0474.08.

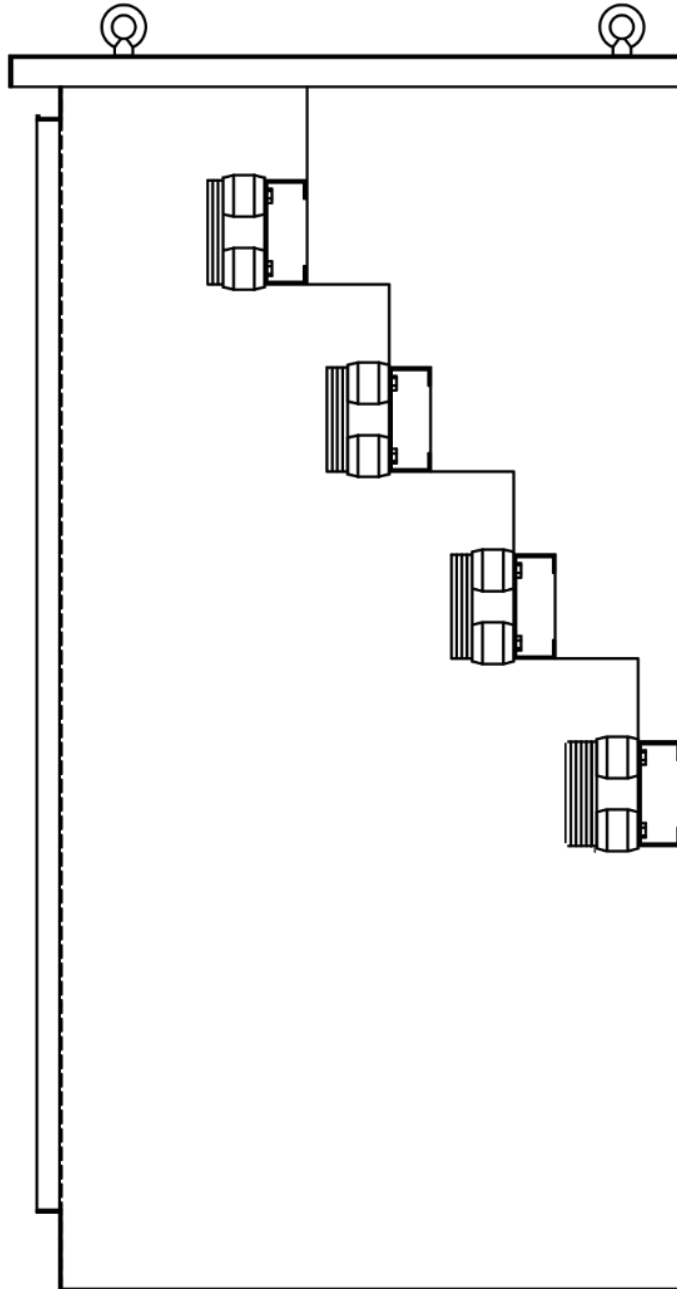
If the cable used is 350 kcmil or greater, the bus bars shall all be located at the top of the cabinet and shall run from front to back as shown in Figure 3.2a.

If the cable used is smaller than 350 kcmil, tiered bus bars may be used as shown in Figure 3.2b or they may be located at the top of the cabinet.

**Figure 3.2a Bus Bars, Top of Cabinet, Front View**



**Figure 3.2b. Bus Bars, Tiered, Side View**



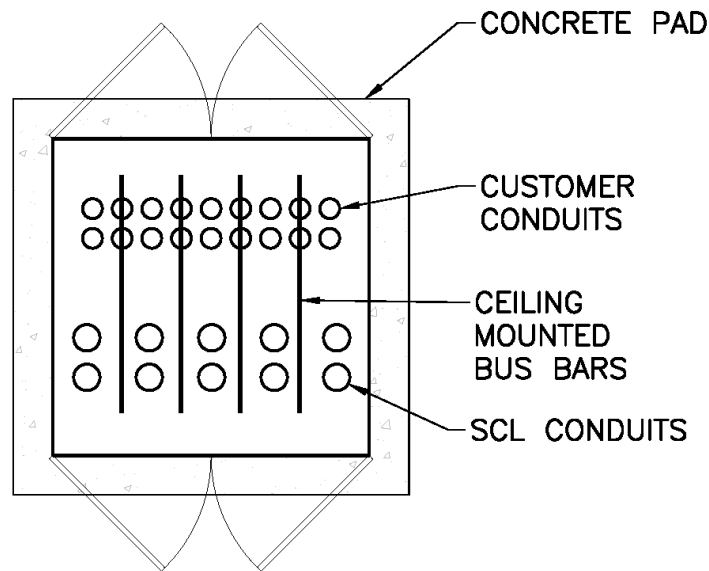
### 3.3 Entrance

Conduits entering the enclosure shall be rigid galvanized steel conforming to SCL 7050.05. The conduits shall extend no more than 3" above the concrete pad.

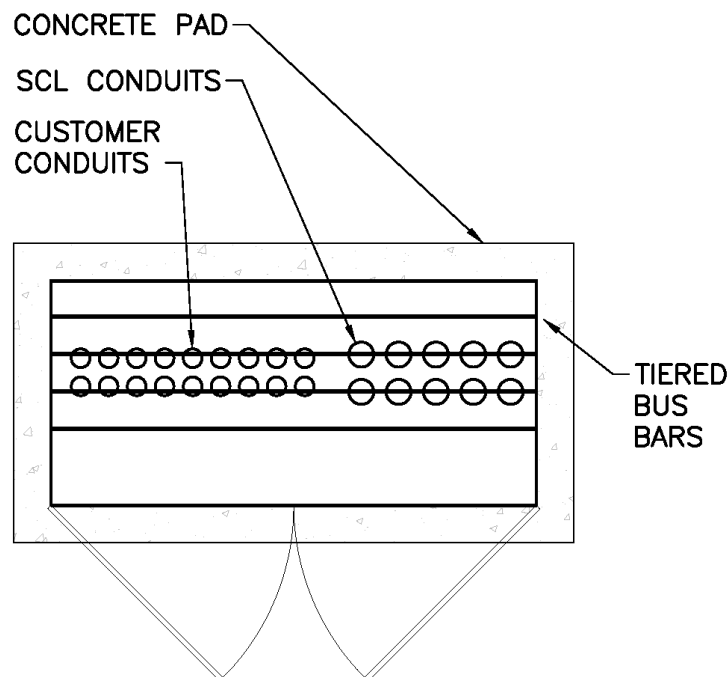
Customer cables shall proceed directly from the entrance conduit to the bus bars with shortest distance such that no excessive slack is stored within the cabinet.

Conduits entering the enclosure shall be arranged as shown in Figure 3.3a and 3.3b.

**Figure 3.3a. Top of Cabinet Bus Bar Conduit Arrangement**



**Figure 3.3b. Tiered Bus Bar Conduit Arrangement**



### 3.4 Clearances

The required working clearance is 10 feet in front of doors or accessible panels, and 3 feet on the other sides. All working clearance areas shall be level and free from obstruction.

### 3.5 Access

The enclosure shall be installed in a location free from obstruction so that it is accessible by truck.

### 3.6 Protection

Protective devices such as bollards or curbs shall be installed when the enclosure is located near vehicular traffic such as a parking lot, loading dock or driveway. The protective devices shall be installed in a location that will protect the enclosure while still meeting the required clearances and allowing for truck access.

---

## 4. References

**SCL Construction Standard 0474.08**; “Looped Radial and Network Dry Vault Service Entrance Bus Duct for Underground Primary Service”

**SCL Material Standard 7050.05**; “Zinc-Coated Steel Conduit and Fittings”

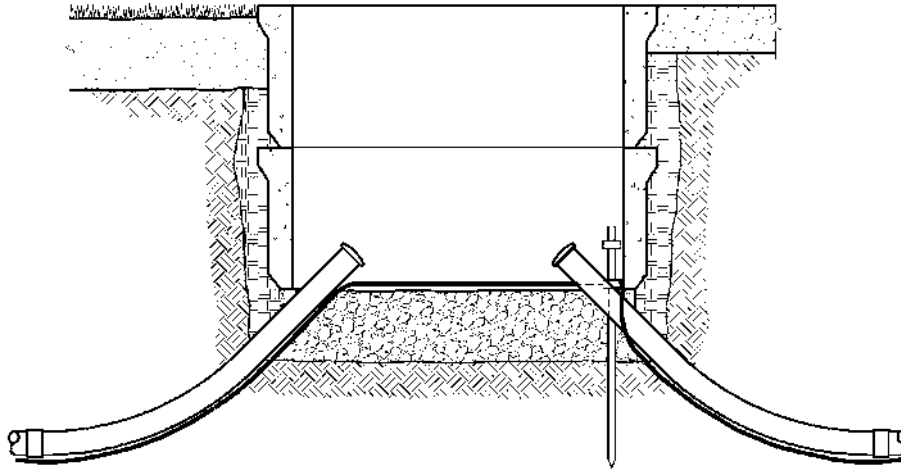
---

## 5. Sources

**Lu, Curtis**; SCL Standards Engineer and originator of 0230.03 (curtis.lu@seattle.gov)

**Lin, Chung-I**; SCL Electrical Power Systems Engineer and subject matter expert for 0230.03 (chung-i.lin@seattle.gov)

## Secondary Handhole Installation and Grounding



### 1. Scope

This standard covers the requirements for secondary handhole installations.

This standard addresses open bottom and closed bottom handholes.

Streetlight handholes are outside the scope of this standard. See Seattle City Light (SCL) 1716.07.

### 2. Application

This standard provides direction to SCL crews and contractors regarding proper installation of secondary handholes owned and maintained by SCL.

For handhole and conduit clearances and orientation, see SCL 0214.00.

### 3. Definitions

**Heavy traffic:** constant vehicular loading (i.e. roadway)

**Medium traffic:** occasional vehicular loading (i.e. driveway)

**Light traffic:** rare vehicular loading (i.e. sidewalk)

### 4. Requirements

#### 4.1 Grounding

Grounding of secondary handholes shall conform to requirements of this standard and SCL 0461.10.

Standard Coordinator  
Brett Hanson

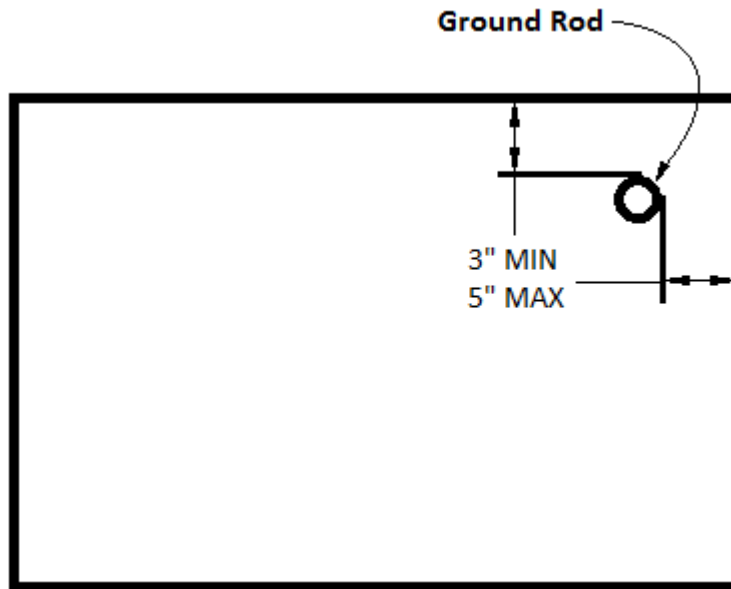
Standards Engineering Supervisor  
John Shipek

Division Director  
Andrew Strong

#### 4.1.1. Ground Rod Locations

Ground rod shall be located in the corner of the handhole and shall not interfere with conduits and wires. See Figure 4.1.1.

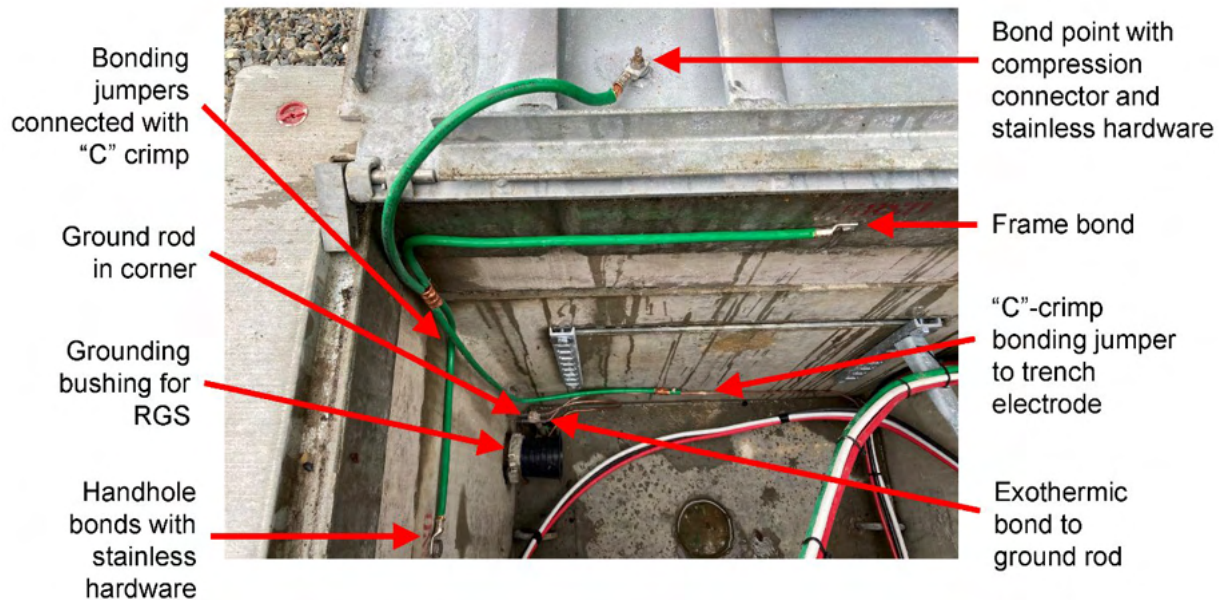
**Figure 4.1.1 Ground Rod Location, Plan View**



#### 4.1.2. Grounding Connections

See Figure 4.1.2. Bond any metal conduits with bushings (Stock No. 013270).

**Figure 4.1.2. Handhole Wiring**





### 4.1.3. Lid Grounding

Choose appropriate method based on traffic load. See Table 4.1.4.

**Table 4.1.3. Lid Grounding**

Traffic Load	Method
Heavy	A
Medium	A
Light	B

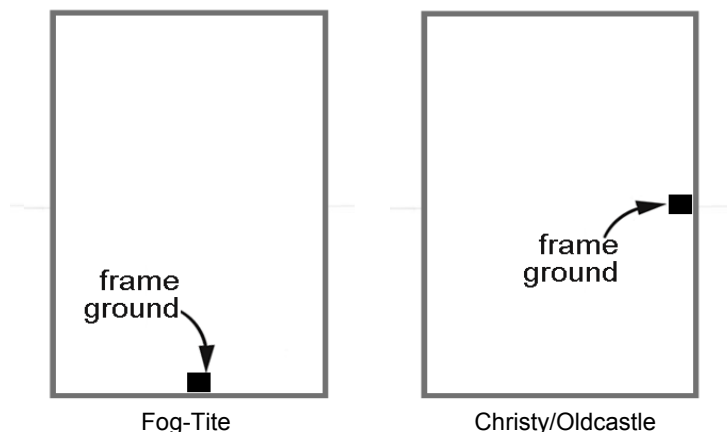
### 4.1.4. Grounding Method A (Example: 17" x 28" Handhole, Heavy or Medium Traffic)

Use precast handhole (stock number 720391) with lid that has factory installed ground strap.

Connect factory ground strap from lid to frame as follows:

1. Install and test grounding electrodes per SCL 0461.10.
2. Install green #6 AWG THWN ground wire (Stock No. 612288) from frame using factory bolt and set screw lug (Stock No. 677065) to trench electrode using connector per SCL 6773.5 or 6773.61.
  - Fog-Tite: manufacturer frame ground bolt is on the center of the long side wall below lip. See Figure 4.1.5.
  - Christy/Oldcastle: frame ground bracket is on the short side wall. See Figure 4.1.5.
3. Bond neutral conductor to a green #8 AWG THWN ground wire (Stock No. 612277) with an irreversible connection. Connect ground wire to ground rod electrode with an irreversible connection listed for direct burial use.

**Figure 4.1.5. Frame Ground Locations**



### 4.1.5. Grounding Method B (Example: 17" x 28" Handhole, Light Traffic)

Use composite fiberglass, reinforced plastic, polymer mortar/concrete handholes (Stock No. 720393) and lid (Stock No. 720397).

This handhole and lid do not require grounding.

Rigid steel conduits shall be bonded.

## 4.2 Conduits

Rigid steel conduit ends shall be protected with plastic bushings and furnished with a ground bushing or grounding clamp.

PVC conduit ends shall be protected with end bells.

Unused conduits shall be plugged and protected.

Used conduits shall be sealed with duct seal or foam.

Conduits shall enter the handhole perpendicular to the walls.

Conduit entrances into the handhole shall be offset to allow cables to wrap in the same direction. See Figure 4.2.

Conduits entering the handhole shall have a minimum cover per SCL 0224.07.

Furnish and install all risers up to 12 inches maximum in order to maintain minimum conduit cover. Risers shall not exceed 12 inches in order to maintain crew hand access to handhole.

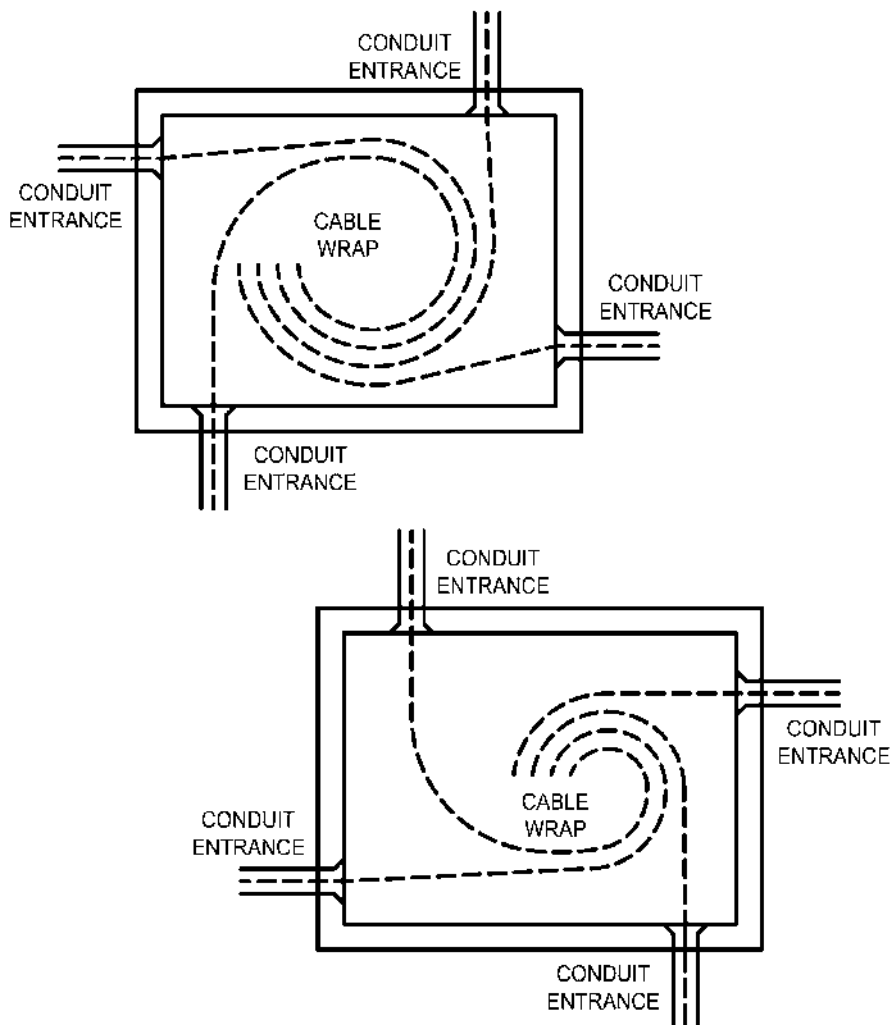
Conduits entering bottomless handholes shall be limited to 3 inches in diameter.

**Table 4.2 Handhole Types and Allowed Conduits**

Handhole Type	Conduit Diameter Allowed (in)			Handhole Maximum Capacity (in) <sup>a</sup>
	2	3	4	
1	yes	yes	no	6
2	yes	yes	no	12
3	yes	yes	no	24
5	yes	yes	yes	48
6	yes	yes	yes	–

<sup>a</sup> Handhole maximum capacity is calculated by multiplying the total number of conduits in the handhole by their diameters.

**Figure 4.2. Offset Conduit, Plan View**



### 4.3 Handholes

Handholes rated H-20 or Tier 22 shall only be installed in planting strips and pedestrian sidewalks where an occasional car or light truck may inadvertently traverse. Handholes in driveways shall be Type 5 or 6 and have an H-30-rated lid.

In backfill, aggregate, and planted areas, handholes shall be installed 1 in above grade. In paved areas, handholes shall be installed flush with grade.

All handhole covers shall have a slip resistant surface that meets the requirements of SCL 7203.01.

Handholes shall be easily accessible and not hidden among planned landscaping that will obscure it over time.

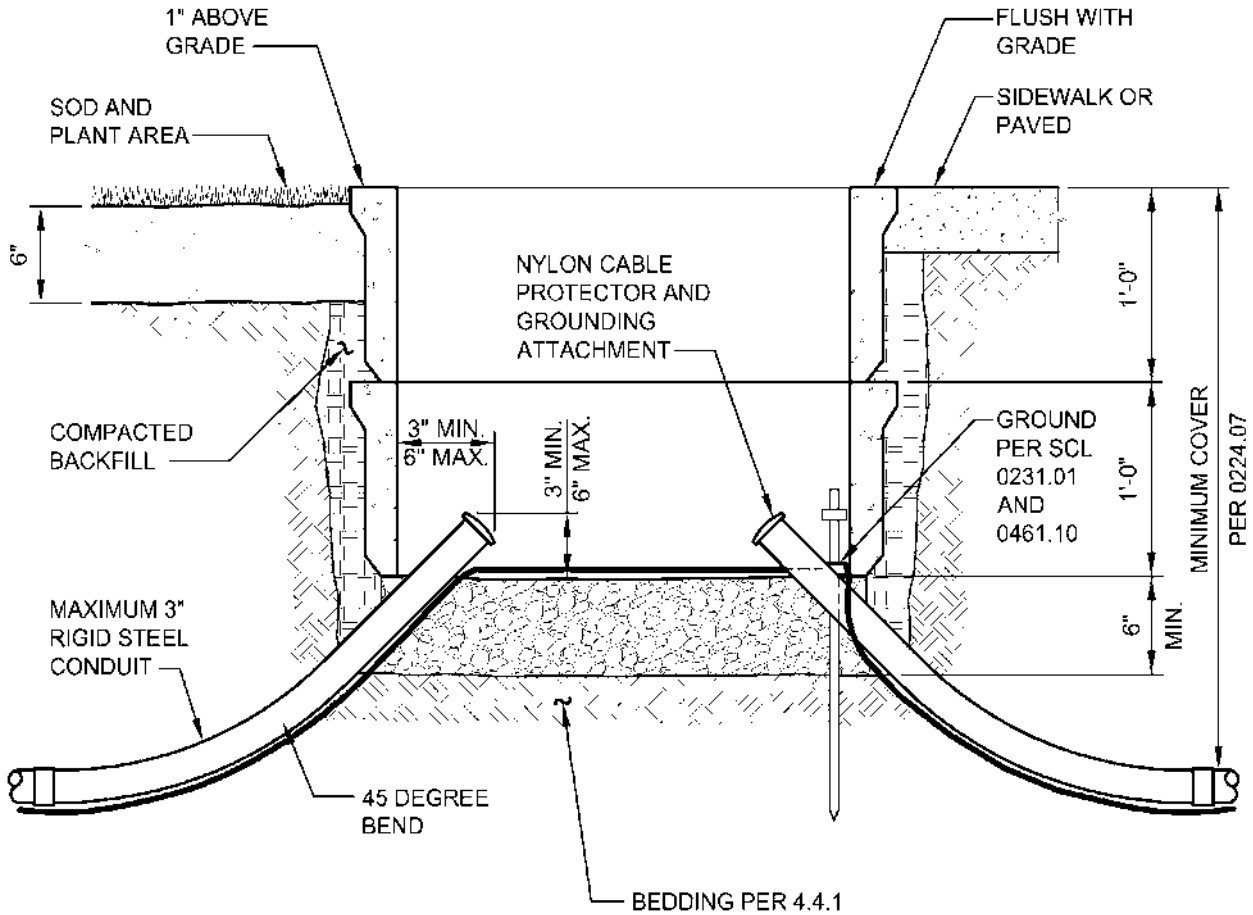
Handholes shall not be located in an area subject to heavy traffic.

Handholes shall be placed to avoid collecting surface water.

**4.3.1 Open Bottom Handhole**

Typical open bottom secondary handhole installation shall conform to Figure 4.3.1.

**Figure 4.3.1. Open Bottom Handhole, Elevation View**



Note: In Looped Radial areas, bends entering bottomless handholes shall be permitted to be standard (STD) radius.

### 4.3.2 Closed Bottom Handhole

All penetrations shall be located in the wall knockout areas and performed by core drill.

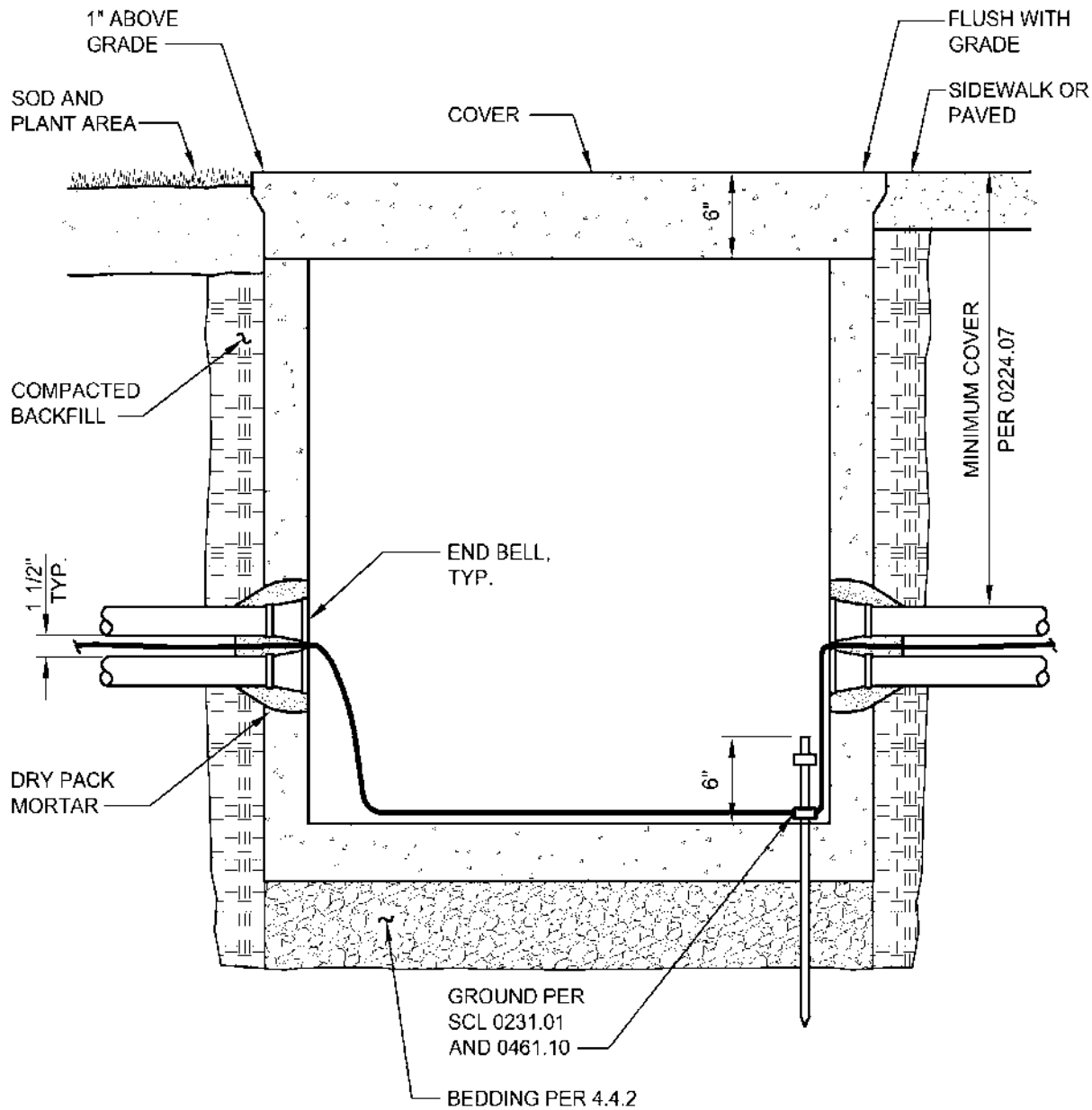
End bells shall be PVC type DB-120 conduit and installed flush with the inside wall of the handhole.

Closed bottom secondary handhole installation shall conform to Figure 4.3.2.

Conduit shall be grouted both inside and outside of the handhole.

If minimum cover shown in Figure 4.3.2 exceeds what can be met with a single 12-inch riser, the next size larger handhole shall be installed.

**Figure 4.3.2. Closed Bottom Handhole, Elevation View**



#### **4.4 Bedding**

##### **4.4.1. Open Bottom Handholes**

Handholes shall be bedded on a minimum of 6 inches of 3/8-in washed gravel, mineral aggregate Type 9.

##### **4.4.2. Closed Bottom Handholes**

The bedding material shall consist of 4 inches to 12 inches of stable base material.

If the excavation bottom is saturated prior to placing bedding material, then over-excavate area as directed by SCL engineer and place cobbles (3 inches to 8 inches stone – no broken concrete).

If excavation is not saturated prior to placing bedding material, compact bottom of excavation with two full compacting operations at right angles to each other with a mechanical compactor.

Place a layer of crushed rock (aggregate grade of 1-1/4 inches minus), screed and compact to a minimum thickness of 4 inches, and add 1/2 to 1-1/2 inches of sand to create a level surface.

**5. Material List**

<b>Description</b>	<b>Stock No.</b>
<b>Handhole, without cover</b>	
Type 2 precast	012978
Type precast extension	720402
Fiberglass	720393
233	013183
3030	013187
444	013093
<b>Conduit, entering handhole</b>	
Straight - Schedule 40 PVC	
2 in	734530
3 in	734532
4 in	734523
Straight - Steel	
2 in	734741
3 in	734743
4 in	734745
Elbow - Steel, 90°	
2 in	734820
3 in	734822
4 in	734824
End Bell – DB120 PVC	
2 in	734938
3 in	734940
4 in	734942
<b>Steel conduit grounding</b>	
Grounding insulated bushing	
2 in	731531
3 in	013270
4 in	012857
Grounding clamp	
2 in	676283
3 in	676285
4 in	676286

## 6. References

**SCL Construction Standard 0214.00**; "Clearances Between SCL Underground Structures and Other Utility Structures in the Public Right-of-Way"

**SCL Construction Standard 0461.10**; "Grounding Electrodes for Handholes and Vaults"

**SCL Construction Standard 1716.07**; "Streetlight Handhole and Conduit Requirements"

**SCL Material Standard 6773.5**; "Connector, Pressure Tap, Copper"

**SCL Material Standard 6773.61**; "Connector, Thin-Wall, Pressure-Tap, Copper"

**SCL Material Standard 7203.01**; "Precast Reinforced Concrete Handholes—General"

---

## 7. Sources

**Chao, Yaochiem**; SCL Standards Engineer, originator, and subject matter expert for 0231.01

**Lu, Curtis**; SCL Standards Engineer and subject matter expert for 0231.01

**Perander, Eivind**; SCL Engineer and subject matter expert for 0231.01

**SCL Construction Standard U2-13.1/NVH-50**; "Typical Handhole with Conduit" (canceled)

**2017 City of Seattle Standard Specifications for Road, Bridge and Municipal Construction**; Section 9-03.16, "Mineral Aggregate Chart"



**Cast-in-Place Risers**



**1. Scope**

This standard covers the requirements for cast-in place risers to bring the vault access to grade.

This standard addresses 42-inch round risers and 5496 equipment hatch risers. The "5496" refers to the riser's inside dimension of 54 in x 96 in.

**2. Application**

This standard provides direction to SCL crews and contractors regarding proper installation of cast-in place risers for slope adjustment on Seattle City Light (SCL)-owned and maintained vaults. Cast-in place risers will be used where standard height risers do not work, or access is located on a sloped grade.

This standard reflects content presented in SCL Power Production & Substations Drawing B-7470. See Appendix.

**3. Requirements**

**3.1 General**

The minimum compressive strength of the concrete shall not be less than 4,000 pounds per square inch in 28 days as determined by the ASTM Method C39.

Concrete finish shall be free of rock pockets and honeycombed areas.

The interior walls and exterior exposed surfaces shall be smooth.

Standards Coordinator  
Quan Wang

Standards Supervisor  
John Shipek

Unit Director  
Darnell Cola

Rock pockets over 3/8-inch-deep and other imperfections on all surfaces shall be patched and troweled to match the surrounding surface.

Steel reinforcing bars shall conform to ASTM A615, Grade 60 or ASTM A706, Grade 60  
 Reinforcing bar size shall be a minimum of #4.

The ends of the reinforcing bars shall have an overlap minimum of 18 in.

Welding of the reinforcing bars shall conform to the Structural Welding Code, Reinforcing Steel (AWS D1.4) of the American Welding Society.

The number of reinforcing bar hoops shall be as described in Table 3.1.

**Table 3.1. Reinforcing Bar Hoop Requirements**

Riser Height of the Low End (t) (in)	# of Rebar Hoops Required
3-4	1
4-6	2
6-8	3
8-10	4

The concrete cover (measured from the surface of the concrete to the outside surface of the reinforcement) for reinforcement shall be a minimum of 2 inches for main reinforcing bars, with a 2-in typical cover on the bottom of the riser.

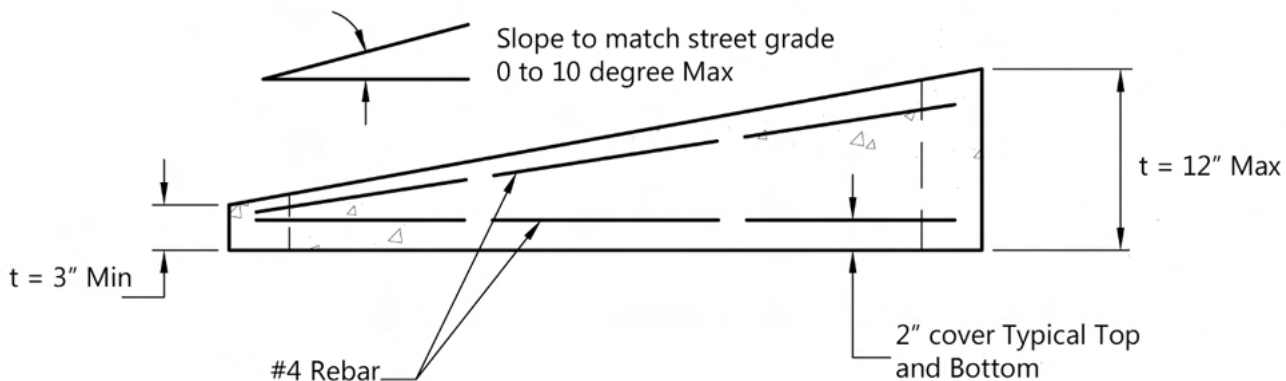
Dimensions shall be as shown in Figure 3.1a.

The keyway shall either 1) be of the dimensions and configuration as shown in Figure 3.1b, or 2) match the surface profile of adjoining piece (roof opening, other riser or casting frame).

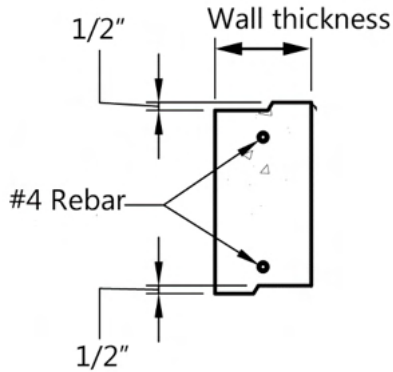
A 2-day minimum cure time shall be required prior to installation of steel cover and frame.

A 4-day minimum cure time shall be required prior to traffic loading.

**Figure 3.1a. Riser Height and Rebar Detail**



**Figure 3.1b. Keyway Detail**



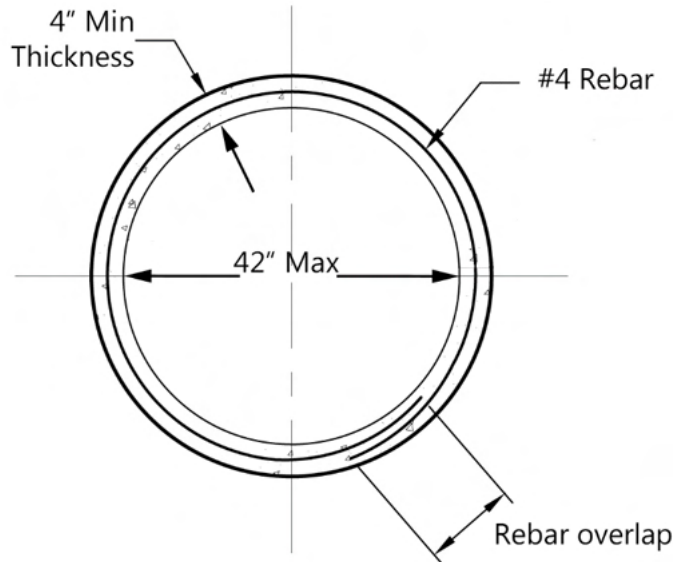
**3.2 Round Riser**

Round risers shall meet the requirements as shown in Table 3.2 and Figure 3.2.

**Table 3.2. Round Riser Requirements**

<b>Wall thickness, minimum</b>	4 in
<b>Inside diameter, maximum</b>	42 in
<b>Outside diameter, maximum</b>	50 in

**Figure 3.2. Round Riser**



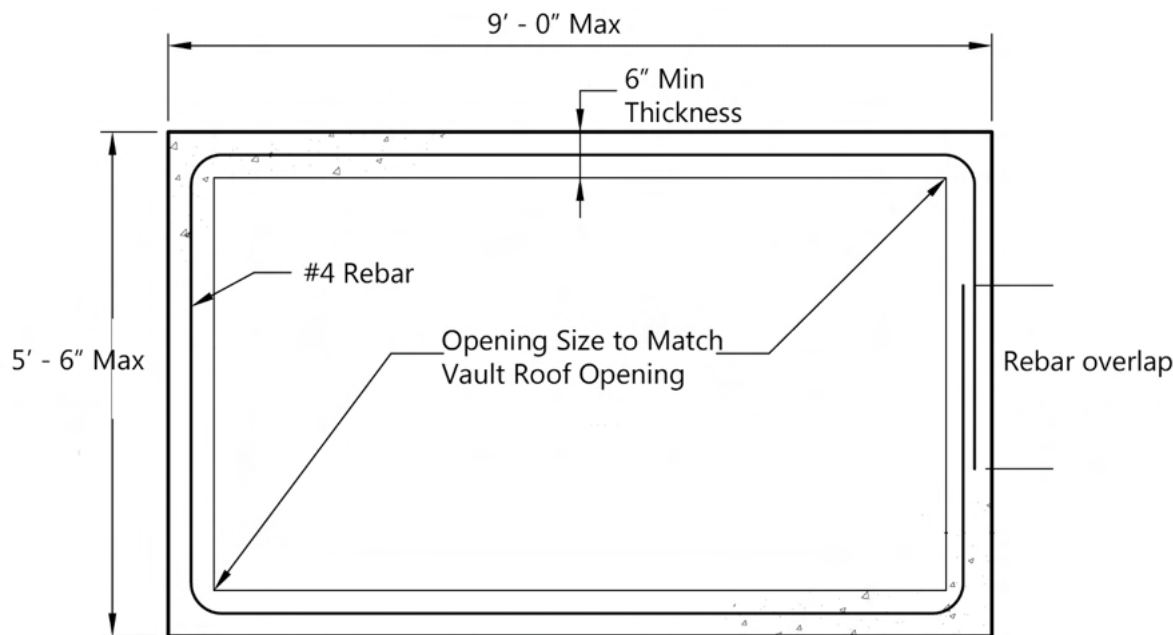
**3.3 5496 Equipment Hatch Riser**

Equipment hatch risers shall meet the requirements as shown in Table 3.3 and Figure 3.3.

**Table 3.3. Equipment Hatch Riser Requirements**

<b>Wall thickness, minimum</b>	Match existing riser outline, 6 in minimum
<b>Outside dimensions, maximum</b>	5 ft-6 in x 9 ft
<b>Inside opening dimensions</b>	Match vault roof opening, 4 ft-6 in x 8 ft (typical)

**Figure 3.3. Equipment Hatch Riser**



#### 4. References

- ASTM A615/A615M-09b**, "Standard Specification for Deformed and Plain Carbon-Steel Bars for Concrete Reinforcement"
- ASTM C39/C39M-10**, "Standard Test Method for Compressive Strength of Cylindrical Concrete Specimens"
- ASTM A706**, "Standard Specification for Deformed and Plain Low-Alloy Steel Bars for Concrete Reinforcement"
- AWS D1.4**, "Structural Welding Code—Reinforcing Steel"
- SCL Power Production & Substations Drawing No. B-7470**, "Cast-in-Place Grade Adjustment Vault Riser"

#### 5. Sources

- Ng, Sharon**; Senior Civil Engineer and subject matter expert for 0231.03 (sharon.ng@seattle.gov)
- SCL Construction Standard U2-6/NVH-20**; "Inspection and Repair Procedures for Precast Vaults and Manholes"
- SCL Construction Standard U2-14.2**; "Vault Installation"
- SCL Construction Standard U2-15.1**; "Installation of Ring Type Vaults"
- SCL Material Standard 7204.15**; "Cover Slabs and Risers for Electric Vaults"

**SCL Material Standard 7203.21**; “Precast Reinforced Concrete Structures – General”

**SCL Material Standard 7204.70**; Frames and Covers, 42-Inch Round, Iron”

**Wang, Quan**; SCL Standards Engineer and coordinator for 0231.03  
([quan.wang@seattle.gov](mailto:quan.wang@seattle.gov))

## Appendix: SCL Drawing B-7470, Cast-in-Place Vault Riser

**NOTES:**

- CAST IN PLACE RISER SHALL BE USED WHEN A SLOPED RISER OR WHEN STANDARD PRECAST RISER SIZE OR HEIGHT DOES NOT WORK FOR THE SITUATION. USE PRECAST RISER (SCL MATERIAL STANDARD 7204.15) WHEN POSSIBLE.
- CONCRETE MINIMUM COMPRESSIVE STRENGTH,  $f_c = 4,000$  PSI AT 28 DAYS.
- CURE TIME: INSTALLING ACCESS COVER/ FRAME - 2 DAYS; TRAFFIC LOADING - 4 DAYS.
- REBAR SHALL BE GRADE 60, ASTM A615. MINIMUM REBAR LAP LENGTH SHALL BE 18".
- RISER KEY SHALL MATCH SURFACE PROFILE OF ADJOINING PIECE (ROOF OPENING, OTHER RISER OR CASTING FRAME).

**RISER REINFORCEMENT**

RISER	NUMBER OF REBAR HOOPS
t= 3" TO 4"	1
t= 4" TO 6"	2
t= 6" TO 8"	3
t= 8" TO 11"	4

**PLAN - ROUND RISER**  
 1/2" - 1'-0"

**PLAN - RECTANGULAR RISER**  
 1/2" - 1'-0"

**ELEVATION A**  
 1" - 1'-0"

**SECTION B-B**  
 1" - 1'-0"

**STANDARDS GENERAL**  
 SYSTEM WIDE  
**CAST IN PLACE GRADE ADJUSTMENT VAULT RISER**

**REVISIONS**

NO.	DATE	BY	DESCRIPTION

**ENDORSEMENTS**

DATE: 7/17/17  
 SIGNATURE: [Signature]  
 CHECKED BY: [Signature]  
 DESIGN: [Signature]  
 CHECK: [Signature]

**APPROVED FOR SEATTLE CITY LIGHT**  
 DATE: 7/10/17

**Seattle City Light**  
 Power Production & Substitutions

**STANDARD SPECIFICATIONS**

THIS DRAWING IS THE PROPERTY OF THE CITY OF SEATTLE. IT IS TO BE USED ONLY FOR THE PROJECT AND SITE SPECIFICALLY IDENTIFIED HEREIN. IT IS TO BE RETURNED TO THE CITY OF SEATTLE UPON COMPLETION OF THE PROJECT. NO PART OF THIS DRAWING IS TO BE REPRODUCED OR TRANSMITTED IN ANY FORM OR BY ANY MEANS, ELECTRONIC OR MECHANICAL, INCLUDING PHOTOCOPYING, RECORDING, OR BY ANY INFORMATION STORAGE AND RETRIEVAL SYSTEM, WITHOUT THE WRITTEN PERMISSION OF THE CITY OF SEATTLE.

**WORK ORDER #**

**DESCRIPTION**

**WORK ORDER #**

**DRAWN BY** [Signature] **CHECKED BY** [Signature] **APPROVED BY** [Signature]

**REV** [Signature] **DATE** [Date] **MAKE** [Date]

**AT FULL SIZE**

**ONE INCH**

C:\BC-Workspace\HERMAN\RA\M-1251ed\m.D-SCLGen\F2016\Projects\Active\SYS - 1303742 - STANDAR D-DRAWING UPGRAD\FS - Structure\B7470.dwg



## Ceiling Channel for In-Building Vaults



### 1. Scope

This standard provides the requirements for the installation of ceiling channels in new or retrofit in-building vaults.

### 2. Application

This standard provides direction to Seattle City Light (SCL) crews and contractors about how to properly install ceiling channels in Network and Looped Radial vaults to support ceiling-mounted equipment including Integrated Web Channel Bus (IWCB) or trapeze-type cable supports.

### 3. Installation

#### 3.1 Spacing

Channels shall be spaced on 22-in centers across the ceiling of all in-building vaults including IWCB vaults. Channel shall be installed level so that the threaded rods hang vertically when attached with standard channel nuts. Channels shall be installed with the channel ends 6 to 12 inches away from the vault walls.

For Network vaults, confirm direction of channels with SCL engineer prior to construction.

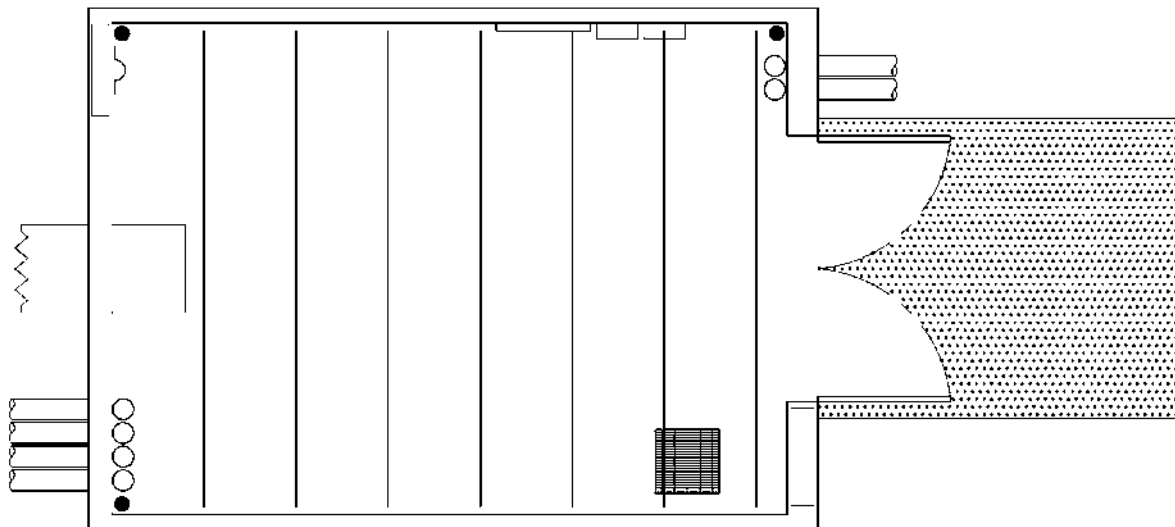
For Looped Radial vaults, channel layout shall be parallel to the wall from which the customer service bus or conduits enter. See Figure 3.1.

Standard Coordinator  
Brett Hanson

Standards Engineering Supervisor  
John Shipek

Division Director  
Andrew Strong

**Figure 3.1 Example Ceiling Channel Layout for a Looped Radial In-Building Transformer Vault**

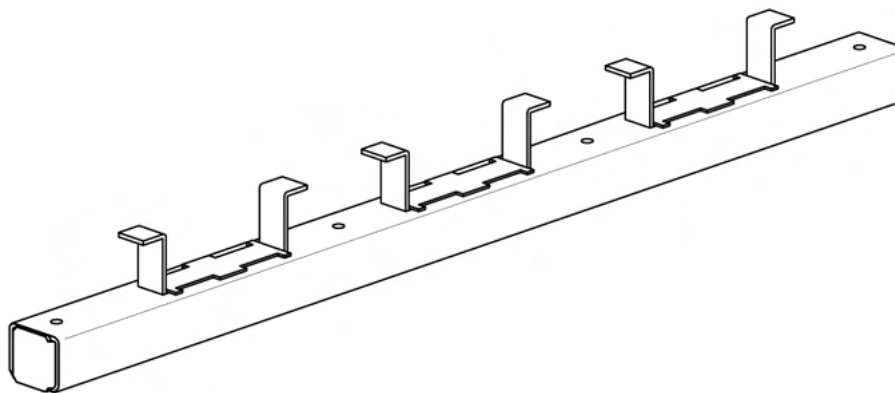


### 3.2 Construction

Concrete insert channels shall be embedded in the ceiling concrete during construction with the bottom of the channel flush with the ceiling surface per manufacturer's instructions. See Figure 3.2.

Concrete inserts shall be 12-gauge, galvanized Unistrut P3200 series (1-5/8 in x 1-3/8 in) or equal.

**Figure 3.2. Concrete Insert**



### 4. References

**Hanson, Brett**; SCL Standards Engineer and originator of 0257.06

**Kohashi, Owen**; SCL Civil Engineer and subject matter expert for 0257.06

**SCL Construction Standard NCI-190** (canceled); "Ceiling Channel for Network Vaults"



## Grounding Electrodes for Handholes and Vaults



### 1. Scope

This standard details the requirements for installing grounding electrodes in Network and Looped Radial vaults and handholes.

This standard does not cover streetlight system grounding electrodes which are detailed in Seattle City Light (SCL) Construction Standard 1710.50.

### 2. Application

This standard provides direction to SCL engineers, crews, inspectors and others about installing a grounding electrode system for use in vaults and handholes.

### 3. Definitions

**Ground electrode:** a conductor or group of conductors in intimate contact with the earth for the purpose of providing a connection with the ground.

**Concrete-encased electrode:** a metallic wire encased in concrete, that is not insulated from direct contact with earth, run as straight as practical for the purpose of providing a connection with the ground.

**Wire electrode:** a bare wire buried in earth, laid approximately straight for the purpose of providing a connection with the ground.

#### 4. Introduction

A safe electrical system is dependent on its grounding and bonding system. Because conductors, exposed metallic components and other conductive surfaces can become energized, it is critical that grounding and bonding systems be installed correctly. Grounding electrodes are a key component of the grounding and bonding system.

Guiding codes, including the National Electrical Safety Code (NESC), recognize that the ground resistance of an electrode should not exceed 25 ohms.

While an individual 5/8-inch diameter by 8 foot long ground rod is an electrode recognized by the NESC and used extensively by SCL to ground poles and other equipment, soil conditions vary widely throughout seasons of the year and throughout the service territory. Additionally, damage to and theft of grounding conductors continues to be an industry-wide problem so augmenting the grounding electrode system is beneficial to both the safety and the efficacy of the distribution system.

Due to these factors, SCL has chosen to supplement the grounding capability of a single ground rod when installed in a handhole or vault by connecting a concrete-encased electrode whenever possible or at the minimum, a wire buried in dirt directly below the conduit route.

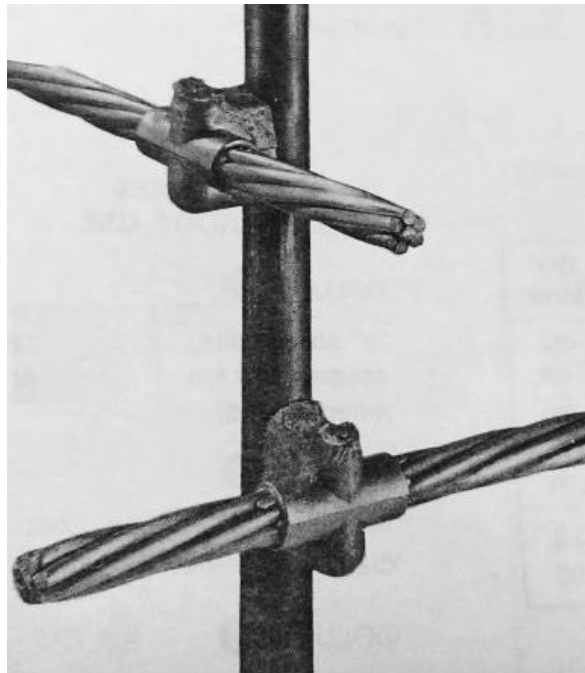
SCL has found installing multiple ground rods at the same location to provide only marginal improvement in reducing ground resistance.

Concrete-encased electrodes are recognized in the industry as a superior grounding electrode in terms of longevity and success in extreme environments and are SCL's preferred grounding electrode for vaults.

Wire buried directly in earth is also a recognized grounding electrode and is an acceptable substitute when a nearby concrete duct bank is not available to form a concrete-encased electrode.

Exothermic weld connections are recognized as a superior method for connecting grounding components as there are no mechanical parts to fail. This is SCL's required grounding connection method. See Figure 4.

**Figure 4. Exothermic weld for cable to ground rod connection, Example**



## 5. Components

The components necessary for constructing vault and handhole grounding electrodes are shown in Table 5.

**Table 5. Grounding Electrode Components**

Description	Stock No.	Material Standard
5/8-in x 8-ft ground rod	564238	6762.25
#2 AWG copper wire, bare, stranded	610434	6103.90
250 kcmil copper wire, bare, stranded	610412	6103.90
#4 AWG copper wire, bare, solid	610208	6102.20

## 6. Connections

The following subsections summarize preferred grounding electrode methods. See Table 6. For each trench of conduits that enters a handhole, provide a grounding electrode and connect via exothermic weld per SCL 0468.90.

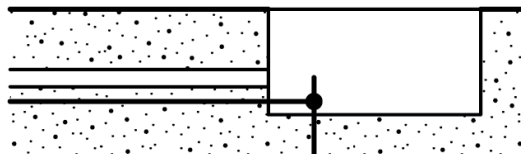
If the grounding electrode recommended below comes in contact with a metallic pole riser conduit, connect with a conduit grounding clamp. See U7-10.9/NDK-120.

**Table 6. Grounding Electrode Methods**

Condition	Single Vault or Handhole	Series of Vaults or Handholes
Conduits in Soil Trench	Install a ground rod in vault or handhole.  For each trench that penetrates vault or handhole, install a 50-ft, wire (#2 AWG for Service or #4 AWG for Streetlight) electrode routed in the bottom of that trench and connect to ground rod with exothermic weld. See Section 6.1.	Install a ground rod in each vault or handhole.  Install a continuous wire (#2 AWG for Service or #4 AWG for Streetlight) electrode routed in the bottom of trench throughout the conduit system. Connect cable electrode to ground rod in each vault or handhole with an exothermic weld. See Section 6.2.
Conduits in Encased Ductbank	Install a ground rod outside the vault or handhole.  For each duct bank that penetrates vault or handhole, install a 50-ft, 250 kcmil, concrete-encased electrode in the bottom of the duct bank. See Section 6.3.	For each duct bank that penetrates vault or handhole, install a 50-ft, 250 kcmil, concrete-encased electrode in the bottom of the duct bank. See Section 6.4.

### 6.1 Direct Buried Conduits Entering a Single Vault or Handhole

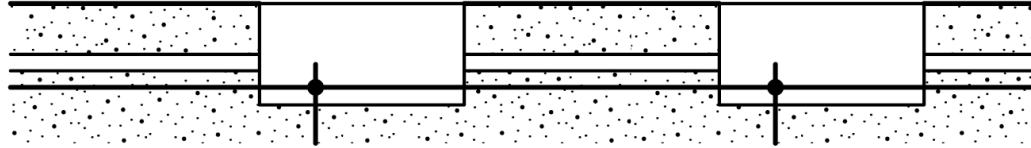
**Figure 6.1. Direct buried conduits entering a single vault or handhole**



Install a ground rod and connect 50 ft of wire (#2 AWG for Service or #4 AWG for Streetlight). Route wire electrode in the bottom of the trench. Drill a hole into each vault wall for each grounding electrode entry. Drill each hole through the vault on the same wall that the conduits enter, above the water table if present. At entry into vault, exothermically weld each wire to eliminate air gaps between strands. Seal the wire's entry into vault with non-shrink grout to prevent water intrusion.

## 6.2 Direct Buried Conduits Entering a Series of Vaults or Handholes

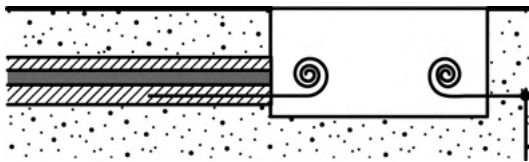
**Figure 6.2. Direct buried conduits entering a series of vaults or handholes**



Install a continuous wire (#2 AWG for Service or #4 AWG for Streetlight) throughout the system and exothermically connect to the ground rod in each handhole. Route wire electrode in the bottom of the trench. Drill a hole into each vault wall for each grounding electrode entry. Drill each hole through the vault on the same wall that the conduits enter, above the water table if present. At entry into vault, exothermically weld each wire by cutting the wire and welding it back together to eliminate air gaps between strands. Seal the wire's entry into vault with non-shrink grout to prevent water intrusion.

## 6.3 Concrete Duct Bank Conduits Entering a Vault or Handhole

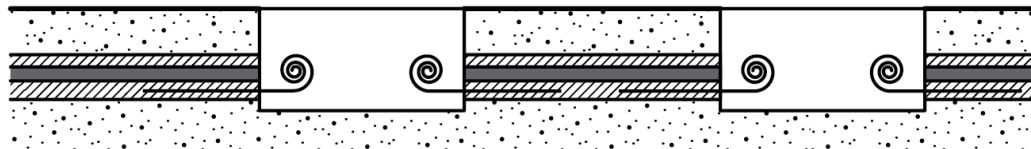
**Figure 6.3. Concrete duct bank conduits entering a vault or handhole**



For each duct bank that penetrates the vault or handhole, install 50 ft of bare 250 kcmil wire in the bottom of that duct bank to form a concrete-encased electrode. Wire must be positioned near the bottom corner of encasement to ensure it is surrounded by a minimum of 2 inches of concrete on all sides when concrete is poured. Install a ground rod outside the vault. For each electrode, install 20 ft of additional wire in order to route it from the electrode, up through drilled hole in vault, and down to common grounding point within vault. Drill a hole into each vault wall for each grounding electrode entry. Drill each hole through the vault on the same wall that the electrode enters, above the water table if present. At entry into vault, exothermically weld each wire by cutting the wire and welding it back together to eliminate air gaps between strands. Seal the wire's entry into vault with non-shrink grout to prevent water intrusion.

## 6.4 Concrete Duct Bank Conduits Enter a Series of Vaults or Handholes

**Figure 6.4. Concrete duct bank conduits enter a series of vaults or handholes**



For each duct bank that penetrates the vault or handhole, install 50 ft of bare 250 kcmil wire in the bottom of that duct bank to form a concrete-encased electrode. Wire must be positioned near the bottom corner of encasement to ensure it is surrounded by a minimum of 2 inches of concrete on all sides when concrete is poured. Install 20 ft of additional wire in order to route it from the duct bank, up through drilled hole in vault, and down to common grounding point within vault. Drill a hole into each vault wall for each grounding electrode entry. Drill each hole through the vault on the same wall that the duct bank enters, above the water table if present. At entry into vault, exothermically weld each wire by cutting the wire and welding it back together to eliminate air gaps between strands. Seal the wire's entry into vault with non-shrink grout to prevent water intrusion.

## 7. Testing

The grounding electrode system shall be constructed to ensure it has a resistance to ground of 25 ohms or less prior to connecting the neutral or service. SCL shall test to confirm compliance. If the electrode system does not result in a resistance to ground of 25 ohms or less, inform SCL engineer. SCL shall advise additional grounding measures required.

---

## 8. References

**SCL Construction Standard U7-10.9/NDK-120**; "Grounding Conduit Risers on Poles"

**SCL Construction Standard 0468.90**; "Exothermic Connection System"

**SCL Material Standard 6102.20**; "Wire, Solid Bare Copper, Dead-Soft-Annealed"

**SCL Material Standard 6103.90**; "Wire, Copper, Bare, Soft-drawn"

**SCL Material Standard 6762.25**; "Ground Rods, Copper-Covered, Sectional"

**SCL Material Standard 6762.90**; "Exothermic Connection System"

---

## 9. Sources

**Hanson, Brett**; SCL Standards Engineer, originator and subject matter expert for 0461.10

**National Electric Safety Code (NEC), C2-2012 Edition**; Institute of Electrical and Electronics Engineers (IEEE), Inc. New York, NY, 2011

**The Authoritative Dictionary of IEEE Standards Terms (IEEE 100-2000)**; Seventh Edition; Institute of Electrical and Electronics Engineers (IEEE), 2000

## Exothermic Connection System



### 1. Scope

This standard identifies the appropriate handle clamp and weld metal capsule to use with a given exothermic mold. It also includes application notes specific to Seattle City Light (SCL). Operator instructions and other literature are cited in Section 5.

### 2. Application

This standard is directed at personnel who plan to install exothermic connections in the field. Design engineers may find this standard helpful when planning or specifying material usage.

To make a connection, the operator inserts the conductors into the appropriate mold, places a weld shot (a small conical cup of weld metal) into the mold receptacle, and attaches the control unit. The assembly is held together by the handle clamp. The operator presses a button on the control unit to initiate the welding operation. (The term “exothermic” means the process gives off heat.)

For copper conductor only.

### 3. Handle Clamp, Weld Metal, and Mold Cross Reference

All jobs will require at least one electronic control unit (ignition tool), Stock No. 013335. This battery-powered ignition tool is designed to make 600 connections on one set of eight standard AA batteries.

Each exothermic connection (mold) will require the use of one of two (reusable) handle clamps and one of a variety of color-coded, (one-shot) weld metal capsules. The appropriate handle clamp and weld metal capsule are identified in Table 3.

Standards Coordinator  
Kathy Tilley

Standards Supervisor  
John Shipek

Unit Director  
Darnell Cola

**Table 3. Exothermic Connection System Components**

Stock No.	Description	Mold	Clamp Handle		Weld Shot	
			Stock No.	Stock No.	Color Code	
013557	4/0 stranded wire butt splice		013336	013560		Gray
013339	250 kcmil wire butt splice		013336	013338		Orange
013401	500 kcmil wire butt splice		013336	013339		Yellow
013402	250 kcmil wire to 5/8-in ground rod		013336	013398		Dk Blue
013403	500 kcmil wire to 5/8-in ground rod		013397	013400		Brown
013441	250 kcmil wire to 3/4-in ground rod		013336	013399		Yellow
013442	500 kcmil wire to 3/4-in ground rod		013397	013440		Lt Brown
013558	4/0 stranded wire all way, horizontal Tee connection		013336	013398		Dk Blue
013559	4/0 stranded wire all way, lapped, horizontal X connection		013336	013561		Purple
013580	#2 AWG stranded wire to 5/8-in ground rod		013336	013560		Gray
013581	#4 AWG solid wire to 5/8-in ground rod		013336	013560		Gray
013585	2/0 stranded wire to 5/8-in ground rod		013336	013560		Gray



## 4. Application Notes

### 4.1 General Installation Notes

Exothermic connection systems are used to form permanent, low-resistance, high-reliability, welded electrical connections that may be direct buried or embedded in concrete.

Exothermic connection systems are commonly used to construct power station ground mats where it is not practical to inspect connections or repair failing connections.

Exothermic connection systems have long been referred to as Cadweld®, however Cadweld® is just one of many manufacturers of such systems.

Molds are available in many configurations for a wide variety of applications.

One mold should make about 50 connections, after which it should be replaced.

Reusable items may be obtained from the warehouse General Section or the Tool Room.

Operators must always wear approved gloves and safety glasses when working with exothermic materials.

### 4.2 Installation Notes Specific to Seattle City Light

Butt-splice molds are used to create water blocks where stranded ground cables enter vaults.

Most cable-to-cable or cable-to-ground rod connections in the Looped Radial and Network distribution systems use 250 kcmil, stranded copper conductors. Counterpoise ground conductors near substations are typically constructed with 500 kcmil, stranded copper. Contact the design engineer for questions regarding choice of conductor size.

Unless noted otherwise, butt splice, T-connection, and X-connection molds are for *horizontal*-lying cable.

---

## 5. References

**SCL Material Standard 6762.90**; "Exothermic Connection System"



## 6. Sources

**CADWELD®** Exothermic Welding Manual, E834I E1123LT08WWEN 0071M9  
(Erico literature file name LT30323)

**CADWELD®** PLUS Control Unit (Erico literature file name LT31163)

**CADWELD®** PLUS Leading Technologies In Exothermic Welding (Erico literature file name LT0414)

**CADWELD®** PLUS Pictorial Instructions, ERICO P/N IPX B295WMPLUS E918IS05WW  
(Erico literature file name LT0580)

**CADWELD®** PLUS Welding Material; MATERIAL SAFETY DATA SHEET (Erico literature file name LT1298)

**CADWELD®** Welded Electrical Connections Facility Electrical Protection Catalog, A1C E1068CT08NAEN 00610M8 (Erico literature file name LT0039)

**CADWELD®** Welded Electrical Connections Quick Reference Product Guide, E782C-NAEN E1820CT07NAEN 0045M8 (Erico literature file name LT1449)

**Electric Railway Improvement Company (ERICO);** [www.erico.com](http://www.erico.com)

**Shipek, John;** SCL Standards engineer and originator of 0468.90  
([john.shipek@seattle.gov](mailto:john.shipek@seattle.gov))

---

## Looped Radial and Network Service Entrance Cables in Conduit for Underground Primary Service

---

### 1. Scope

This standard covers the requirements for a customer service provided by NEC-sized cables routed in conduit to the point of termination located in the Seattle City Light (SCL) Looped Radial or Network System.

An underground secondary service from an overhead transformer or underground transformer located in the right-of-way is outside the scope of this standard. See SCL 0224.01.

---

### 2. Application

This standard provides direction to customers about how to select cable in conduit systems to meet SCL requirements. The goal is to inform the customer of the requirements and available options as well as giving the crews defined requirements to reference.

Vault requirements are outside the scope of this standard. See SCL 0732.50 and 0751.60.

---

### 3. Requirements

Customers are responsible for providing National Electrical Code (NEC)-sized service conduits and cables from the service termination point to the customer's switchgear. Tables 3a. and 3b. show allowable conductor sizes.

Route cable through the incoming conduit and coil excess cable equal to the sum of the length and width of the vault. In the case of a padmount transformer, provide 8 feet. The additional cable will insure SCL crews can arrange equipment where it is most practical for installation and maintenance. The additional cable may be cut at any point, so it shall not be used as additional impedance for the customer switchgear fault current calculation. Visibly mark each cable indicating phase and service being fed.

---

Standards Coordinator  
Brett Hanson



Standards Supervisor  
John Shipek



Unit Director  
Andrew Strong



**Table 3a. Allowed Cables in Looped Radial System**

	Copper	Aluminum	
	Concentric Round Stranded	Concentric Round Stranded & Compressed Stranded	Compact Stranded
#2 AWG	OK	OK	–
#1 AWG	–	OK	OK
1/0 AWG	OK	OK	OK
2/0 AWG	OK	OK	OK
3/0 AWG	OK	OK	OK
4/0 AWG	OK	OK	OK
250 kcmil	OK	OK	OK
300 kcmil	OK	OK	OK
350 kcmil	OK	OK	OK
400 kcmil	–	OK	OK
500 kcmil	OK	OK	OK
600 kcmil	OK	OK	OK
700 kcmil	–	OK	OK
750 kcmil	OK	OK	OK
800 kcmil	–	OK	OK

Note: 600-800 kcmil cables are only allowed on large projects with prior SCL approval.

**Table 3b. Allowed Cables in Network System**

	Copper (Stranded)	Aluminum (Stranded)
#4 AWG	OK	–
#2 AWG	OK	–
#2/0 AWG	OK	–
#4/0 AWG	OK	OK
250 kcmil	OK	–
350 kcmil	OK	OK
500 kcmil	OK	OK
750 kcmil	–	OK

Note: No compact sector cables are allowed.

#### 4. References

**SCL Construction Standard 0224.01**; “Customer Requirements for Underground Secondary Service, Looped Radial System”

**SCL Construction Standard 0732.50**; “Customer Requirements for Below-Grade Transformer Service Vaults, Looped Radial System”

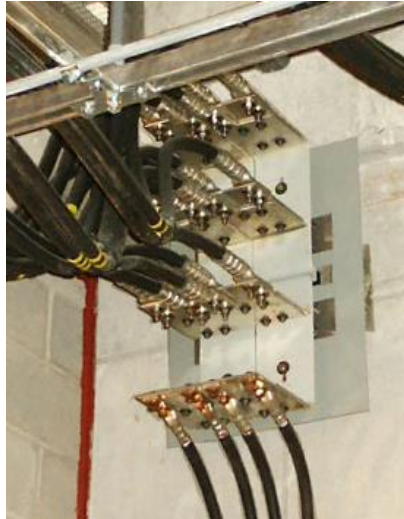
**SCL Construction Standard 0751.60**; “Concurrent Customer Requirements, In-Building Transformer Vaults”

#### 5. Sources

**Hanson, Brett**; SCL Standards Engineer and originator for 0473.50  
 (brett.hanson@seattle.gov)

**Perander, Eivind**; SCL North Distribution Supervisor and subject matter expert for 0473.50  
 (eivind.perander@seattle.gov)

## Looped Radial and Network Dry Vault Service Entrance Bus Duct for Underground Primary Service



### 1. Scope

This standard covers the installation, clearance and equipment requirements for a dry vault service entrance bus duct located in the Seattle City Light (SCL) Looped Radial or Network System.

Dry vaults are those above grade or otherwise not subject to flooding or wet interior conditions.

Minimum vault dimensions are outside the scope of this standard.

### 2. Application

This standard provides direction to SCL crews and customers about how to design and build the dry vault service entrance bus duct to meet SCL requirements and applicable codes. The goal is to inform the customer of the requirements and available options as well as giving the crews defined requirements to reference.

Standards Coordinator  
Brett Hanson

Standards Supervisor  
John Shipek

Unit Director  
Darnell Cola

### 3. Requirements

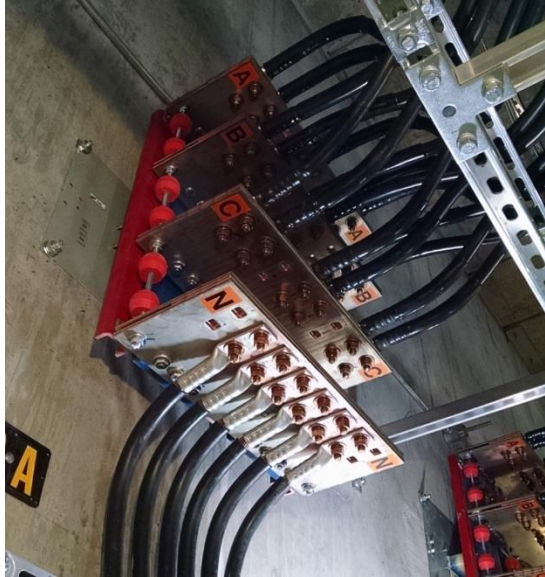
- 3.1 City Light will determine the number of cable connections per phase and neutral.
- 3.2 The bus shall extend a maximum of 18 inches from the vault wall as shown in Figures 3.10b and 3.10e.
- 3.3 The ceiling clearance for the bus shall be a minimum distance of 18 inches from the top of the bus to the ceiling unless otherwise accepted by SCL. This 18-inch clearance must extend for a minimum distance of four feet in front of the bus, away from the wall.
- 3.4 The minimum horizontal distance between two adjacent service entrance buses shall be 3 feet. See Figure 3.10i. Confirm bus duct height and vault dimensions with SCL Engineer prior to construction. For electrical clearances, see SCL 0751.77. Mount adjacent buses at the same height above finished floor.
- 3.5 The minimum distance between bus phases shall be 8 inches. See Figures 3.10c and 3.10e.
- 3.6 Buses or connector plates shall be drilled to accept NEMA two-hole connectors. Each connector space on the plate shall be drilled with two 9/16-in holes, spaced 1-3/4 inches on center. Each connector space shall be offset 2-1/4 inches from adjacent connector spaces. See Figures 3.10g and 3.10h.
- 3.7 Each bus shall have a placard identifying the unique load it serves, ampacity, voltage, and phases. Each phase shall also be labeled. The placard shall be red phenolic with white letters 1 in tall minimum and be mounted adjacent to or below each bus. See Figure 3.7a.

**Figure 3.7a. Example Placard for Dry Vault Service Entrance Buses**

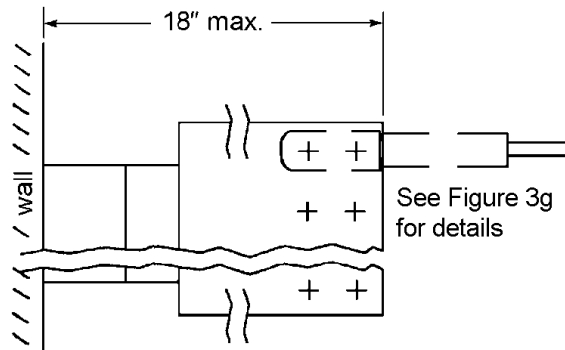


- 3.8 Customer shall submit a dimensioned sketch of customer service bus duct design, location of service bus, and bus rating to SCL Engineer for review and approval.
- 3.9 The customer shall furnish and install fire stop insulating material per NEC 300.21 requirements for service bus duct installed by the customer. Prior to acceptance of the vault by SCL, the customer shall have the fire protection material inspected and approved by the Authority Having Jurisdiction (AHJ).
- 3.10 The customer shall be responsible for assuring that water never enters the building and service entrance equipment from SCL vaults.

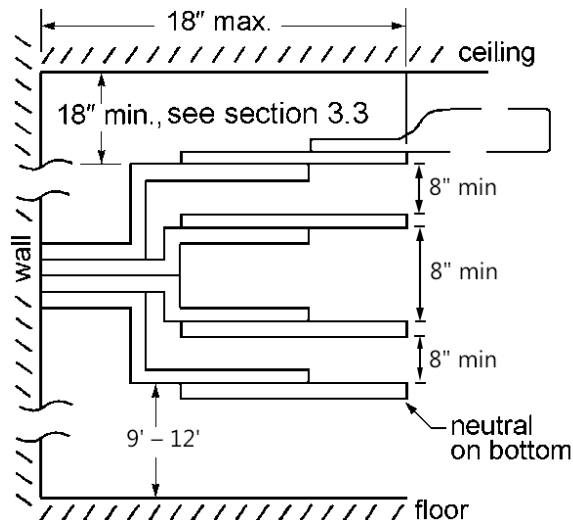
**Figure 3.10a. Bus Bars Parallel to Floor**



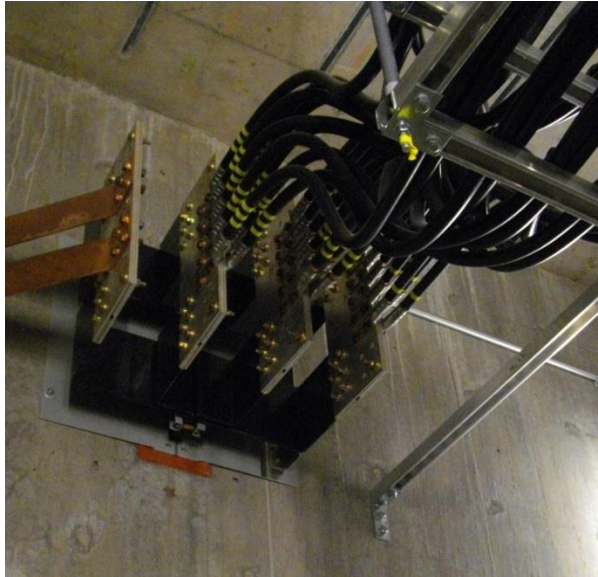
**Figure 3.10b. Bus Bars Parallel to Floor, Plan View (Cables Parallel to Floor)**



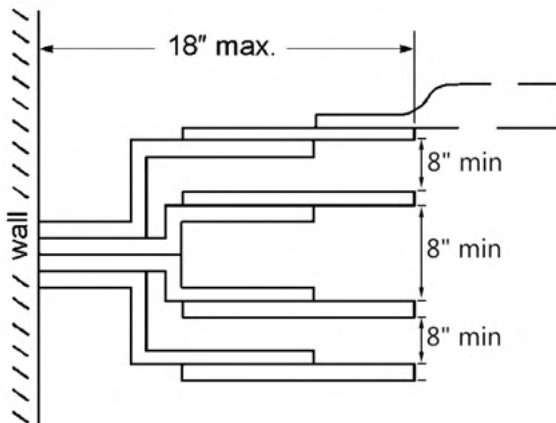
**Figure 3.10c. Bus Bars Parallel to Floor, Elevation View (Cables Parallel to Floor)**



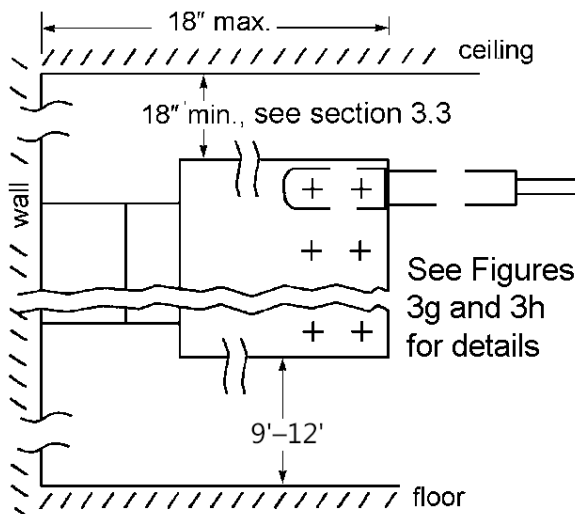
**Figure 3.10d. Bus Bars Perpendicular to Floor**



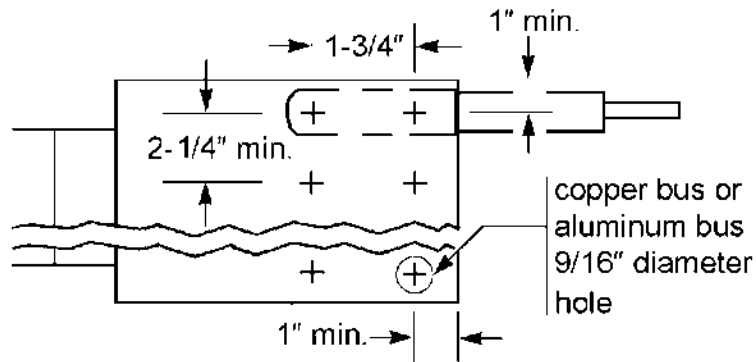
**Figure 3.10e. Bus Bars Perpendicular to Floor, Plan View**



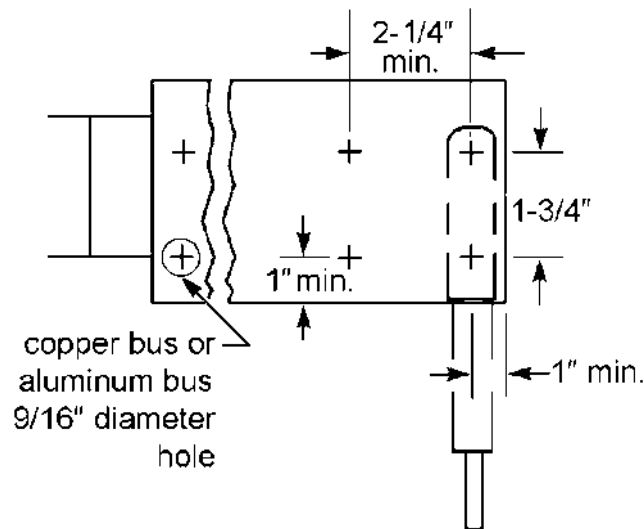
**Figure 3.10f. Bus Bars Perpendicular to Floor, Elevation View (Cables Parallel to Floor)**



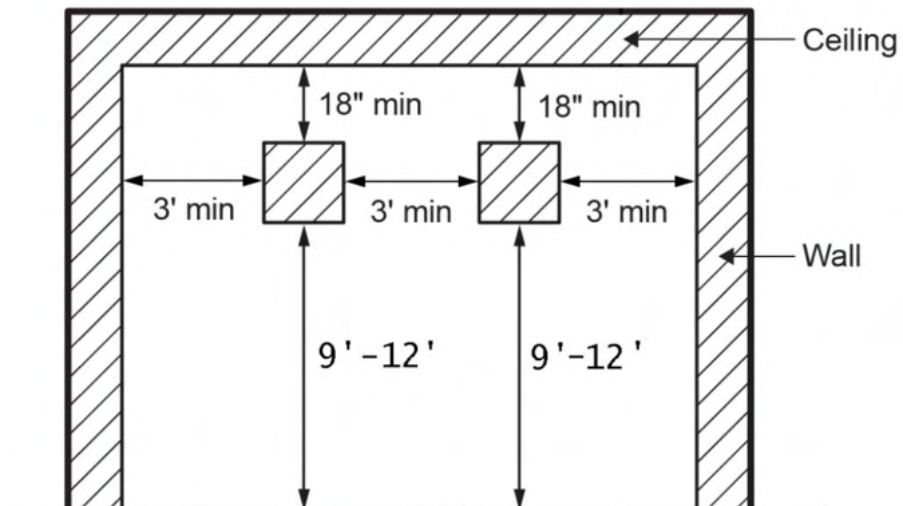
**Figure 3.10g. Hole Spacing, Two-Hole Horizontal Connection**



**Figure 3.10h. Hole Spacing, Two-Hole Vertical Connection**



**Figure 3.10i. Adjacent Service Entrance Bus Spacing**





#### 4. References

**SCL Construction Standard 0751.77**, "In-Building Vault Electrical Equipment Clearances"

---

#### 5. Sources

**Hanson, Brett**; SCL Standards Engineer and subject matter expert for 0474.08  
(brett.hanson@seattle.gov)

**NESC 2011 Section 124**; "Guarding Live Parts"; NESC; 2012

**NEC 2014 Section 300.21**; "Spread of Fire or Products of Combustion"; NEC; 2014

**SCL Construction Standard NCB-160** (canceled), "Network Spot or System Dry Vault Service Entrance Bus"

**SCL Construction Standard U11-9.1** (canceled), "Bus Extensions and Cable Tap Boxes"

**Youngs, Rob**; SCL Electrical Inspector and subject matter expert for 0474.08  
(rob.youngs@seattle.gov)

## In-Building Vault Lighting and Receptacle Requirements, Looped Radial System



---

### 1. Scope

This standard outlines the lighting and receptacle requirements for a dry, in-building, transformer vault in the Seattle City Light (SCL) looped radial system. It also includes application notes specific to SCL.

---

### 2. Application

This standard is directed at personnel who install the light fixtures and receptacles in dry in-building transformer vaults in the SCL Looped Radial system. SCL shall make final connections to power once the light fixtures and receptacles have been installed and wired.

---

### 3. Lighting Requirements

Surface-mount a plastic lamp holder (Cooper Wiring S1174W) centered on each wall at 8 ft above finished floor. If a wall exceeds 15 ft in length, install lamp holders 10 ft on center. Install a light switch (lighted handle, Leviton 1201-LHW or equal) inside each door at 42 inches above finished floor. Provide 3-way or 4-way switches as necessary. Furnish and install lamps for the fixtures (Satco S39391 LED 5000K or equal, Stock No. 014551). If vault walls are 8 ft tall or less, mount lamp holders on the ceiling, 12 inches away from the wall.

---

### 4. Receptacle Requirements

Surface-mount one duplex NEMA 5-20R receptacle below each lamp holder at 42 inches above finished floor.

---

Standards Coordinator  
Brett Hanson

Standards Supervisor  
John Shipek

Unit Director  
Andrew Strong

## 5. Wiring Requirements

Circuits shall be routed within EMT 1/2-inch conduit (minimum) that is mounted to the surface of the vault walls. Homerun junction boxes shall be installed at 42 inches above finished floor. All junction boxes shall be 4-inch square steel and furnished with cover plates. Light fixtures shall be connected to one circuit including dedicated hot, neutral, and ground conductors. Receptacles shall be connected to a separate circuit including dedicated hot and neutral conductors.

Lighting and receptacle circuits shall be installed using different colored jackets to distinguish the hot and neutral conductors of each circuit. All conductors shall be #12 THWN, and 3 ft of extra conductor shall be left at the homerun junction boxes for final connection by Seattle City Light.

Seattle City Light crews shall connect to the homeruns via fuses and use #4 THWN conductors if the 120 V source is outside the vault.

Permanent power for the vault lighting and receptacles shall be supplied directly from SCL equipment.

---

## 6. Sources

**SCL Construction Standard U10-6**, "Lighting and Sump Pump Installation for Single Transformer Vaults" (canceled)

**Youngs, Rob**; SCL Inspector and subject matter expert for 0674.06  
(rob.youngs@seattle.gov)

**Hanson, Brett**; SCL Standards engineer and originator of 0674.06  
(brett.hanson@seattle.gov)

## Customer Requirements for Padmount Transformer Services, Looped Radial System

---

### 1. Scope

This standard provides the requirements for Seattle City Light (SCL) looped radial system transformer pad services. This standard does not provide requirements for in-building vaults.

Requirements for in-building vaults are outside the scope of this standard.

For transformers located within in-building vaults, refer to SCL 0751.00 and 0751.60.

For transformers installed outside in below-grade vaults, refer to SCL 0732.50.

---

### 2. Application

This standard provides direction to customers, contractors, and SCL crews about where and how to properly install padmount transformer services and construct structures around transformers.

---

### 3. Conflict

Where conflict exists between SCL requirements, the following order of precedence shall apply:

1. Project-specific Customer Requirements Package, including the Service Construction Letter and Drawing
  2. SCL 0724.50
  3. Seattle Building Code, 2015, Section 428 (within the City of Seattle)
  4. Other SCL construction standards
  5. Other industry standards
- 

### 4. General Requirements

See project-specific construction package for:

- Transformer pad location
- Bollards, if required

Conduits shall extend 3 inches above the surface of the pad. Grout and use petroleum resistant sealant around conduits.

Elbows shall be rigid galvanized steel.

All exposed metallic conduits shall have a grounding bushing or a bushing plus a ground clamp.

---



#### **4.1 High Voltage (Primary) Conduits**

- 4.1.1** Provide and install two 4-inch conduits from the pad to the utility facility specified in the project-specific Customer Requirements Package. A maximum of 270 degrees of bends are allowed in the primary conduit run, unless otherwise specified in the project-specific Customer Requirements Package.
- 4.1.2** Install and terminate below-grade conduit per SCL 0214.00 and 0222.02. If applicable, provide and install conduit risers on the pole per SCL 0224.34. Orientation and arrangement of conduit risers will be shown in the project-specific Customer Requirements Package.

#### **4.2 Secondary Conduits**

The customer shall furnish and install NEC-sized conduit and phase and neutral conductors of sufficient length to connect to the transformer terminals. See SCL 0473.50 for cable options. The conduit location shall be designated by SCL. If more than four conductors per phase and neutral are installed, the customer may be required to provide a secondary termination facility. For eight or more secondary conduits contact SCL Engineer for layout. See SCL 0224.07.

#### **4.3 SCL Access**

Provide properly supported, unobstructed access from the right-of-way to the transformer pad for SCL equipment-handling machinery. SCL must be able to move to the transformer pad, or remove from the transformer pad, all electrical equipment, including tall, heavy transformers, and to service electrical equipment using SCL equipment handling machinery.

Provide unobstructed clear space above each pad so that SCL can move transformers using SCL equipment handling machinery. Provide a permanent, level, unobstructed, 8-ft wide working area to the pad. If any portion of the building extends within 3 feet of the footprint of the pad, an Equipment Transportation Agreement is required that will be attached to the property title. The agreement requires the building owner to move transformers to and from the transformer pad, to a mutually agreed upon location on, or in the vicinity of, the owner's property from which SCL is able to deliver or pick up the transformers using normal transporting methods and equipment. Any damage that occurs to the transformers during transportation by the building owner and any additional expense incurred as a result of damage shall be paid by the building owner.

#### **4.4 Transformer Pad Location**

Pad shall be located in order to satisfy Figures 4.4a, 4.4b, and 4.4c. Combustible and noncombustible structures are defined by the Authority Having Jurisdiction.

Provide a minimum of 10 feet unobstructed working clearance on the conduit-opening side of the pad, and a minimum of 3 feet of clear space on the three other sides of the pad, for SCL crew's working-space and the pad's ground ring. If curbs are used for protection instead of bollards, any side of the transformer pad exposed to traffic shall have a continuous minimum 8-inch-tall structural curb installed 10 feet from the nearest edge of the pad.

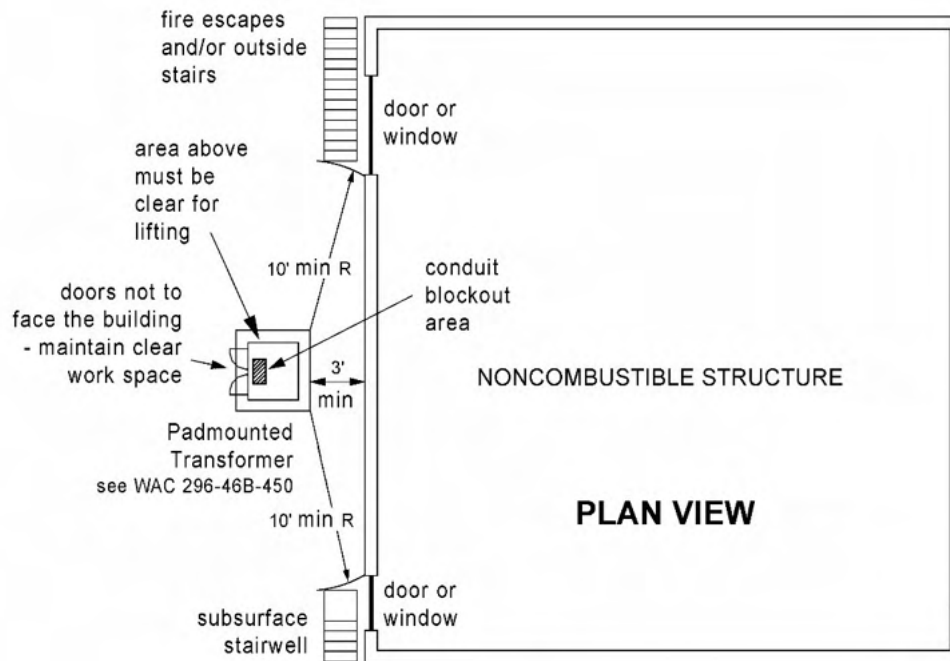
Foundations, footings, structures, tanks, piping, etc. are not allowed within the footprint of the transformer pad, grounding ring, or oil containment system.

Maintain a minimum of 25 feet unobstructed vertical working clearance from the top of the pad to any trees.

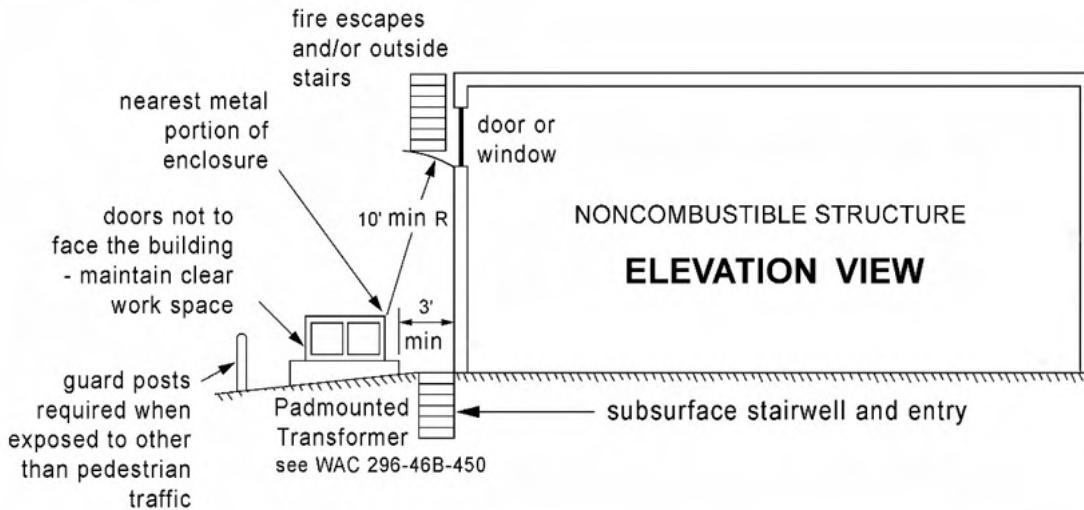
Transformer pad must be a minimum of:

- 10 feet from any property line between private properties.
- 10 feet from building doors or windows.
- 10 feet from combustible structures.
- 7 feet from noncombustible conductive (metal) structures.
- 3 feet from noncombustible nonconductive structures.
- 10 feet horizontally from any trees. The distance shall be measured from the tree's root ball to the nearest edge of the pad.

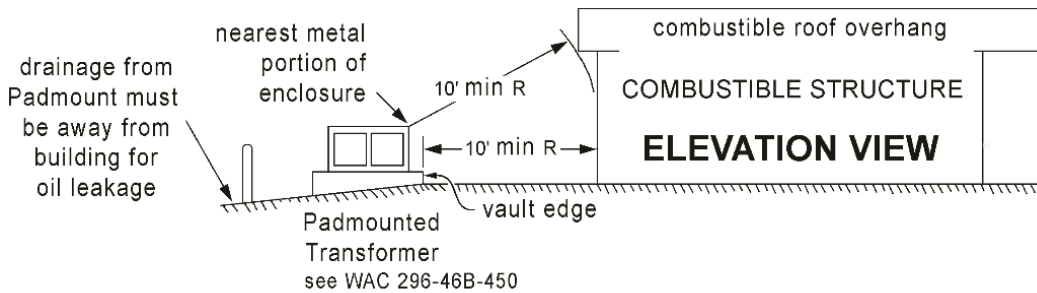
**Figure 4.4a. Noncombustible Structures** (for combustible structures, see Figure 4.4c.)



**Figure 4.4b. Noncombustible Structures Elevation View** (for combustible structures, see Figure 4.4c.)



**Figure 4.4c. Combustible Structures, Elevation View**



#### 4.5 Bollards

After the transformer has been set on the pad, install highly-visible, non-conductive 8-inch diameter minimum by 8-foot long rigid posts, Ceme-Tube Bollard or structural equivalent, to protect the transformer from vehicles. Insert posts to a depth of 4 feet and fill with concrete per manufacturer's instructions.

Locate bollards outside of the oil containment system.

Locate bollards a minimum of 4 feet away from the transformer door side of the pad so that the doors will open 180 degrees.

Locate bollards a minimum of 3 feet away from the transformer pad on the other three sides of the transformer.

See project-specific construction package for bollard locations. Install bollards no more than four feet apart.

#### 4.6 Soundproofing

Isolate transformer pad so that sound and vibration levels from transformers satisfy applicable laws and ordinances of the State of Washington, King County, and the appropriate municipality.

#### **4.7 Oil Containment**

Provide oil containment per SCL 0735.50.

If precast or cast-in-place oil-containment system is installed separately from the transformer pad, connect the pad to the system.

Connections shall be made with a minimum of eight (8) concrete anchors or rebar dowels: one near each corner and one at the middle of each side.

Connections shall be made a minimum of 6 inches from pad edges and 4 inches clear of the lifting inserts.

Rebar dowels or rod shall be embedded a minimum of 4 inches into the foundation or oil containment slab.

Concrete anchors shall be stainless steel (ASTM F593 - AISI 304/316 SS) and 3/4 inches minimum in diameter.

Rebar dowels or rods shall be stainless steel (ASTM F593 - AISI 304/316 SS) and #6 (nominal 3/4 inches) minimum diameter. The seam between the precast transformer pad and the oil containment system shall be grouted to prevent oil or water seeping into the interface.

---

#### **5. Pad Requirements**

Three-inch high capital letters, "SCL," shall be cast in the concrete pad surface, facing the outside, centered between the long side of the conduit opening and the nearest outside edge of the pad.

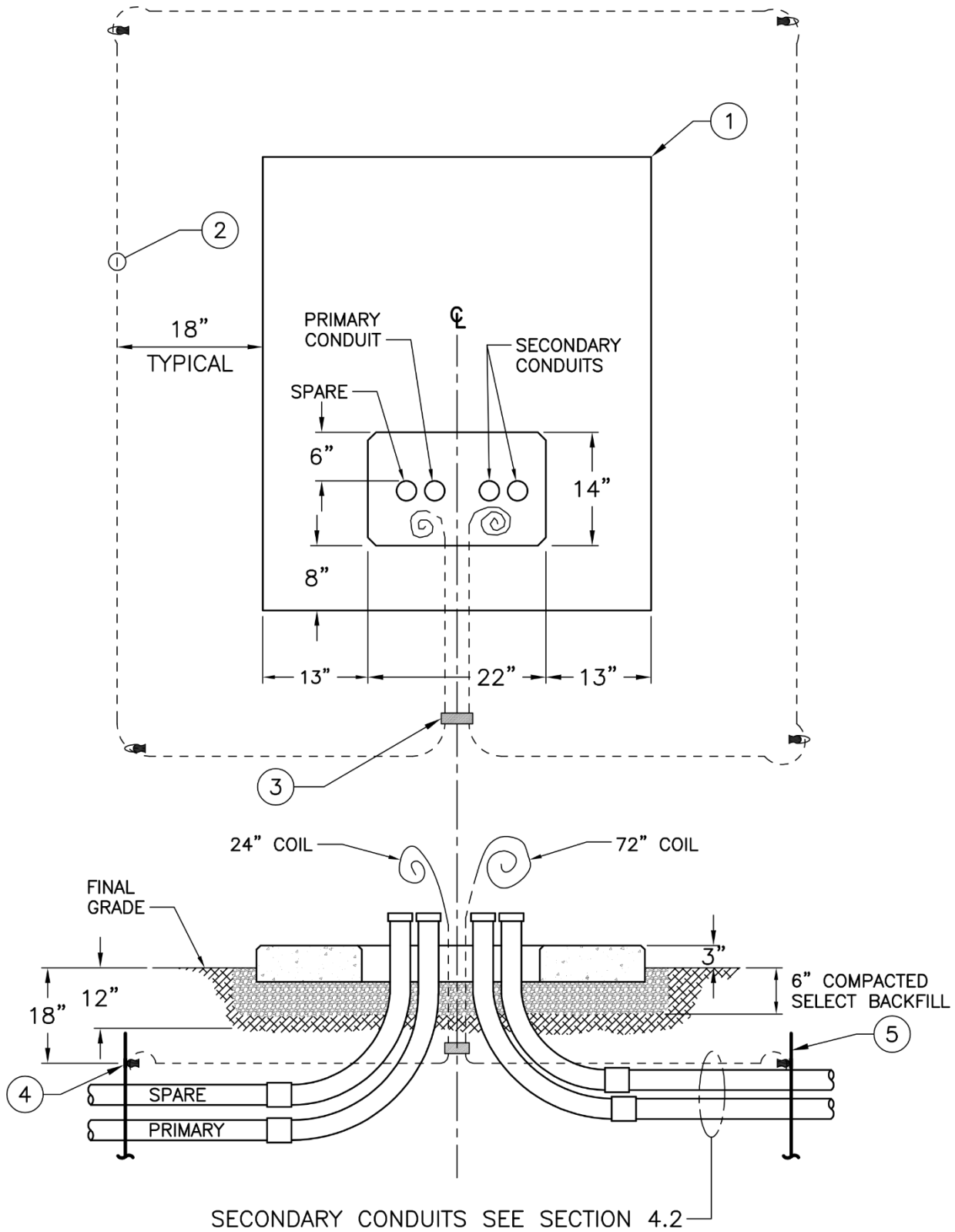
Furnish and install pad, wire, ground rods, and connectors per Table 5 and Figures 5a, 5b, 5c, and 5d.



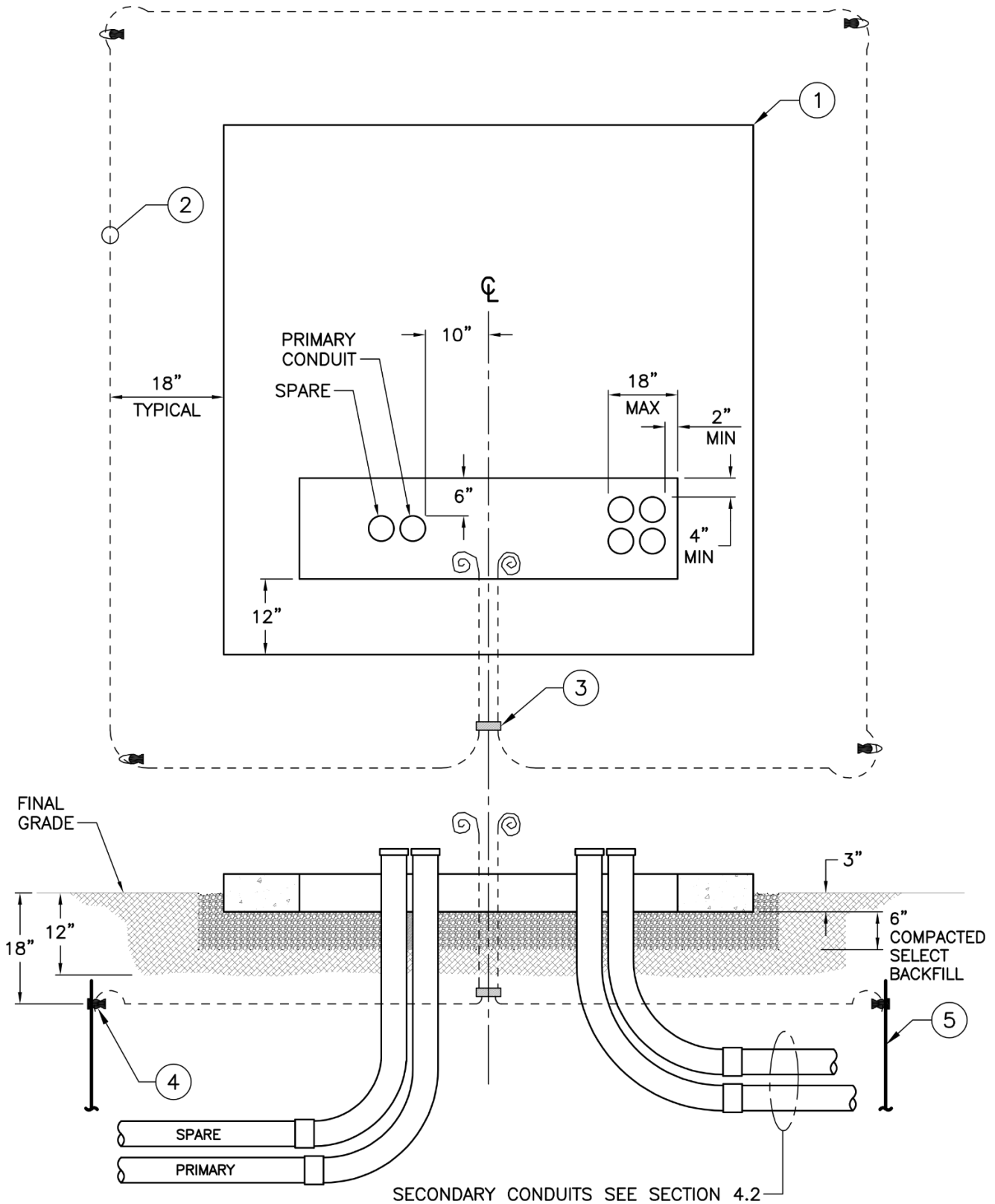
**Table 5. Material List**

Item No.	Item	Figure			
		5a	5b	5c	5d
1	<b>Transformer Pad</b>				
	Dimensions (W x L, inches)	48 x 56	84 x 84	96 x 93	96 x 120
	Stock No., Matl Std 7203.76	013721	013722	013723	013724
-	<b>Transformer</b>				
	120/240V (kVA Range)	25-167	N/A	N/A	N/A
	208Y/120V (kVA Range)	N/A	150	225-500	750-1000
	480Y/277V (kVA Range)	N/A	150-300	500-1000	1500-2500
2	<b>Ground Wire</b>				
	Trade Size	#2 AWG	#2 AWG	2/0 AWG	2/0 AWG
	Quantity (ft)	40	55	60	65
	Stock No., Matl Std 6103.90	610434	610434	610425	610425
3	<b>Connector</b>				
	Stock No., Matl Std 6693.70	669379	669379	669379	669379
4	<b>Exothermic Weld</b>				
	Quantity	4	4	4	4
	Stock No., Matl Std 6762.90	013580	013580	013585	013585
5	<b>Ground Rod</b>				
	Quantity	4	4	4	4
	Stock No., Matl Std 6762.25	564238	564238	564238	564238

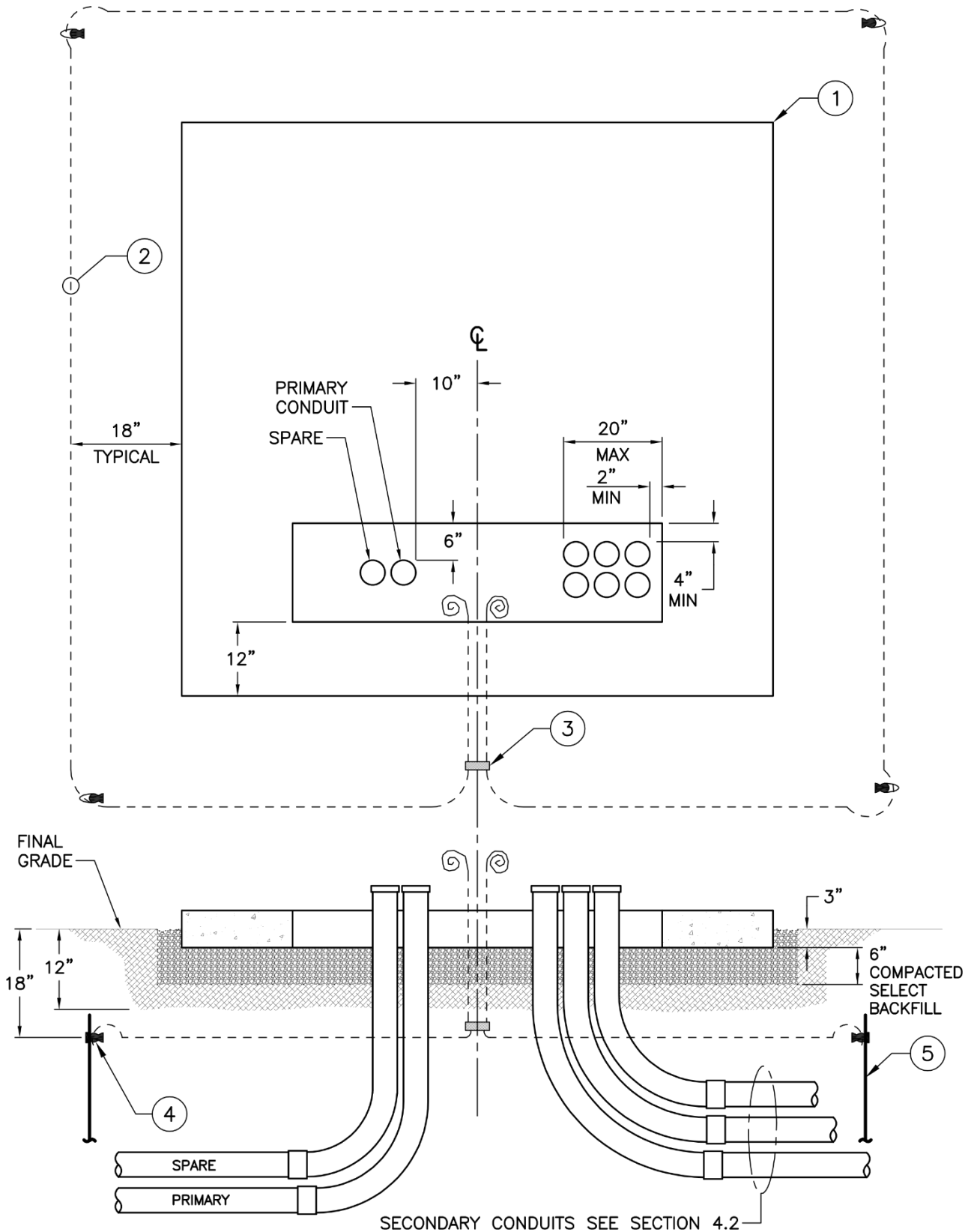
**Figure 5a. Single-Phase Transformer Pad Requirements**



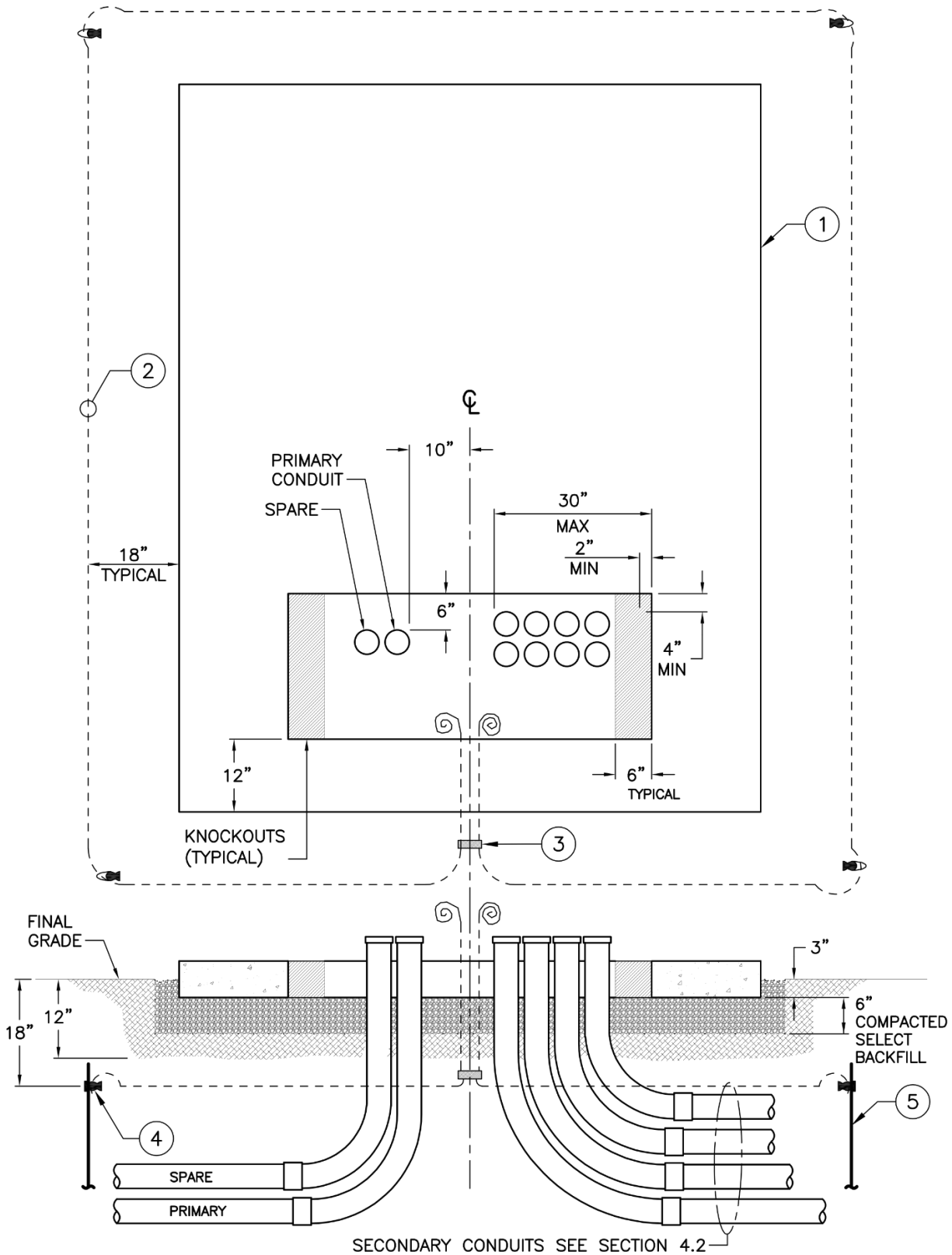
**Figure 5b. Small Three-Phase Transformer Pad Requirements**



**Figure 5c. Medium Three-Phase Transformer Pad Requirements**



**Figure 5d. Large Three-Phase Transformer Pad Requirements**



## 6. Grounding

Furnish and install grounding per Table 5 and Figures 5a, 5b, 5c, and 5d.

Ground ring must form a complete rectangle as shown in Figures 5a, 5b, 5c, and 5d, and when tested by SCL, provide a resistance to ground of 25 ohms or less.

All below-grade connections shall be done by exothermic weld per SCL 0468.90.

For the primary conduit duct bank that enters the transformer terminal compartment, install 50 ft of bare 250 kcmil wire in the bottom of that duct bank to form a concrete-encased electrode. Wire must be straight and positioned to ensure it is surrounded by 2 in of concrete on all sides when concrete is poured. From the duct bank electrode, extend 6 ft of additional wire into the transformer primary terminal compartment to connect it to the transformer grounding lug.

---

## 7. References

**SCL Construction Standard 0214.00**; “Clearances between SCL Underground Structures and Other Structures”

**SCL Construction Standard 0222.02**; “Requirements for Primary Conduit and Duct Bank Installation”

**SCL Construction Standard 0224.07**; “Requirements for Secondary Conduit Installation”

**SCL Construction Standard 0224.34**; “Steel Conduit Risers”

**SCL Construction Standard 0468.90**; “Exothermic Connection System”

**SCL Construction Standard 0473.50**; “Looped Radial and Network Service Entrance Cables in Conduit for Underground Primary Service”

**SCL Construction Standard 0732.50**; “Customer Requirements for Below-Grade Transformer Service Vaults, Looped Radial System”

**SCL Construction Standard 0735.50**; “Oil Containment Systems”

**SCL Construction Standard 0751.00**; “Customer Requirements, In-Building Transformer Vaults, Network and Looped Radial Systems”

**SCL Construction Standard 0751.60**; “Concurrent Customer Requirements, In-Building Transformer Vaults”

---

## 8. Sources

**Hanson, Brett**; SCL Standards Engineer and originator of 0724.50  
(brett.hanson@seattle.gov)

**Lin, Chung**; SCL Electrical Engineer and subject matter expert for 0724.50  
(chung-i.lin@seattle.gov)

**Perander, Eivind**; SCL Electrical Engineer and subject matter expert for 0724.50  
(eivind.perander@seattle.gov)

**SCL Construction Guideline U10-7 (canceled)**; “Requirements for Transformer Pads and External, Below-Grade Transformer Service Vaults, Looped Radial System”

**SCL Construction Standard 0461.10**; “Grounding Electrodes for Handholes and Vaults”

**SCL Material Standard 7203.76**; “Precast Reinforced Concrete Transformer Pads”

## Customer Requirements for Below-Grade Transformer Service Vaults, Looped Radial System

### 1. Scope

This standard provides the requirements for Seattle City Light (SCL) looped radial system below-grade transformer service vaults.

For transformers located within in-building vaults, refer to SCL 0751.00 and 0751.60.

For transformers installed outside on pads, refer to SCL 0724.50.

### 2. Application

This standard provides direction to customers, contractors, and SCL crews about where and how to properly install below-grade transformer vaults and construct structures around existing vaults.

### 3. Conflict

Where conflict exists between SCL requirements, the following order of precedence shall apply:

1. Project-specific Customer Requirements Package, including the Service Construction Letter and Drawing
2. SCL 0732.50
3. Seattle Building Code, 2015, Section 428 (within the City of Seattle)
4. Other SCL construction standards
5. Other industry standards

### 4. General Requirements

#### 4.1. Vault High Voltage (Primary) Entrance

##### 4.1.1

Provide and install two 4-inch conduits from the vault to the utility facility specified in the project-specific Customer Requirements Package. A maximum of 270 degrees of bends are allowed in the primary conduit run, unless otherwise specified in the project-specific Customer Requirements Package.

##### 4.1.2

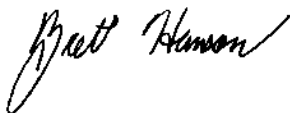
Install and terminate below-grade conduit per SCL 0214.00 and 0222.02. If applicable, provide and install conduit risers on the pole per SCL 0224.34. Orientation and arrangement of conduit risers will be shown in the project-specific Customer Requirements Package.

##### 4.1.3

Conduits entering the vault shall be supplied with closing plugs.

Conduit shall enter the vault perpendicular to the vault wall no more than 18 inches from the adjacent wall.

Standards Coordinator  
Brett Hanson



Standards Supervisor  
John Shippek



Unit Director  
Andrew Strong



All duct terminations into vaults shall be done by core drill.

Provide and install PVC-type DB-120 conduit end bells flush with the interior walls on all conduits entering the vault. The conduits shall be grouted both inside and outside of the vault. See SCL 7055.09 for approved manufacturers.

A minimum of 6 inches shall be required between the closest edge of the conduit and the adjacent ceiling or walls.

The first two feet of all conduits exiting the vault shall be vertically and horizontally perpendicular to the vault face.

If there are multiple duct banks or direct-buried conduits entering horizontally and at right angles to each other in the same corner of a vault, they shall enter at different elevations so they are vertically offset to the other.

#### **4.2 Secondary Conduits**

The customer shall furnish and install NEC-sized conduit and phase and neutral conductors of sufficient length to connect to the transformer terminals. See SCL 0473.50 for cable options. The conduit location shall be designated by SCL. If more than six conductors per phase and neutral are installed, the customer may be required to provide a secondary termination facility. Conduits from the transformer vault to the secondary termination facility shall meet SCL 0224.07.

#### **4.3 SCL Access**

Provide properly supported, unobstructed access from the right-of-way to the transformer vault for SCL equipment-handling machinery. SCL must be able to move to the transformer vault, or remove from the transformer vault, all electrical equipment, including tall, heavy transformers, and to service electrical equipment using SCL equipment handling machinery.

Provide 25 feet clear space above each vault so that SCL can move transformers using SCL equipment handling machinery. Provide a permanent, level, unobstructed, 8-ft wide working area around the vault.

#### **4.4 Vault Location**

Vault shall be located in order to satisfy Figures 4.4a, 4.4b, and 4.4c. Combustible and noncombustible structures are defined by the Authority Having Jurisdiction.

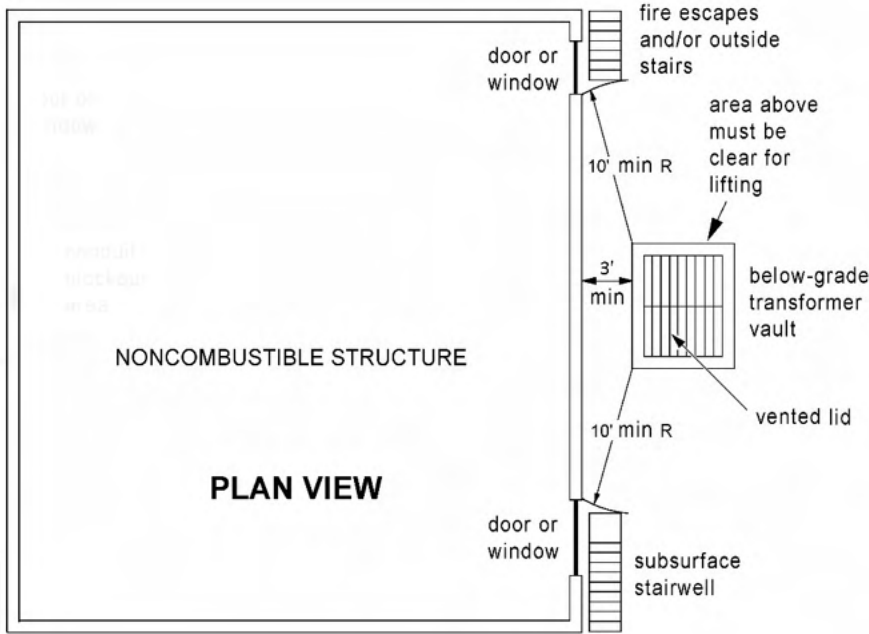
Maintain a minimum of 25 feet unobstructed vertical working clearance from the top of the vault to any trees or structures.

Transformer vault must be a minimum of:

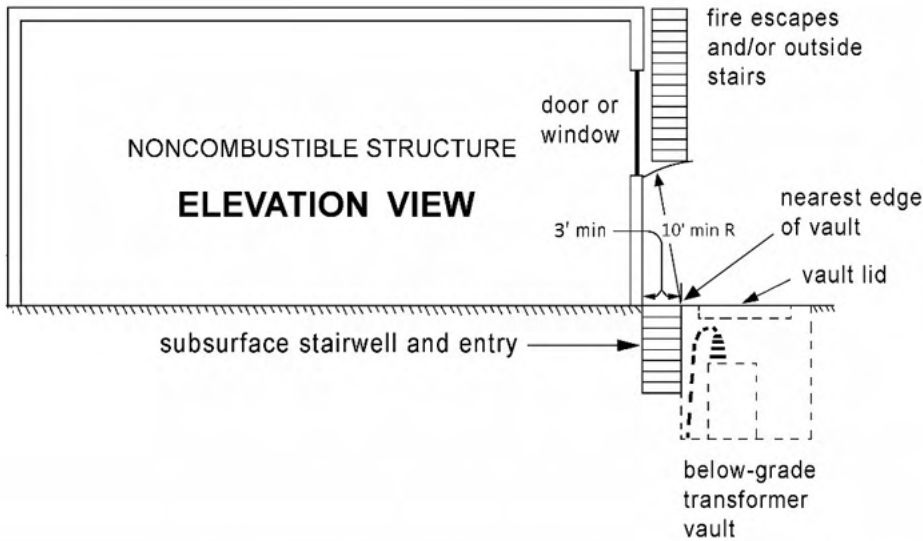
- 10 feet from any property line between private properties.
- 10 feet from building doors or windows.
- 10 feet from combustible structures.
- 7 feet from noncombustible conductive (metal) structures.
- 3 feet from noncombustible nonconductive structures.
- 10 feet horizontally from any trees. The distance shall be measured from the tree's root ball to the nearest edge of the vault.



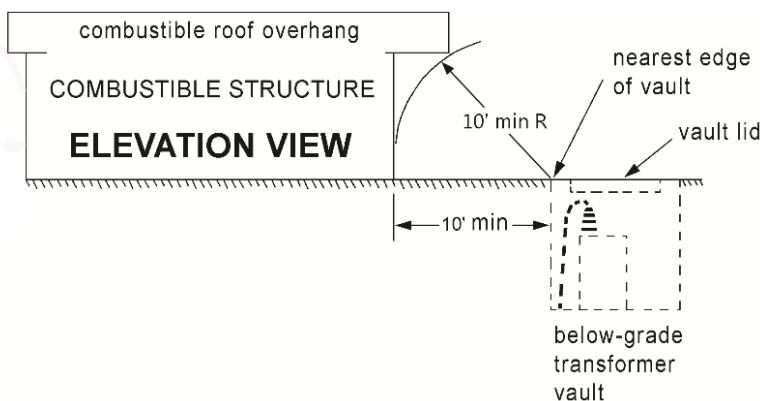
**Figure 4.4a. Noncombustible Structures, Plan View** (for combustible structures, see Figure 4.4c.)



**Figure 4.4b. Noncombustible Structures, Elevation View** (for combustible structures, see Figure 4.4c.)



**Figure 4.4c. Combustible Structures, Elevation View**



## 5. Vault Requirements

Install vault per SCL U2-14.2 and SCL U2-15.1.

Confirm minimum vault dimensions with the SCL Engineer.

Customer shall furnish and install fire stop insulating material per NEC requirements for service conduits and service bus duct that are installed by the customer in the customer's building or service equipment.

It shall be the customer's responsibility to assure that water does not enter the building and does not enter customer service entrance equipment from SCL vaults. The service termination facility must be above grade if the customer's service gear is at an elevation lower than the lid of the transformer vault.

Sump and grate shall be located underneath the hatch, next to the nearest wall.

Provide grounding per SCL 0461.10.

## 6. References

**SCL Construction Standard U2-14.2**; "Vault Installation"

**SCL Construction Standard U2-15.1**; "Installation of Ring-Type Vaults"

**SCL Construction Standard 0214.00**; "Clearances between SCL Underground Structures and Other Utility Structures in the Public Right-of-Way"

**SCL Construction Standard 0222.02**; "Requirements for Duct Banks in the Public Right-of-Way"

**SCL Construction Standard 0224.34**; "Steel Conduit Risers"

**SCL Construction Standard 0461.10**; "Grounding Electrodes for Handholes and Vaults"

**SCL Construction Standard 0473.50**; "Looped Radial and Network Service Entrance Cables in Conduit for Underground Primary Service"

**SCL Construction Standard 0751.00**; "Customer Requirements, In-Building Transformer Vaults, Network and Looped Radial Systems"

**SCL Construction Standard 0751.60**; "Concurrent Customer Requirements, In-Building Transformer Vaults"

**SCL Construction Standard 0724.50**; "Customer Requirements for Padmount Transformer Services, Looped Radial System"

**SCL Construction Standard 0224.07**; “Requirements for Secondary Conduits in the Right-of-Way”

**SCL Material Standard 7055.09**; “DB120, PVC Conduit Fittings”

---

## 7. Sources

**Hanson, Brett**; SCL Standards Engineer and originator of 0732.50

**Lin, Chung**; SCL Electrical Engineer and subject matter expert for 0732.50

**Perander, Eivind**; SCL Electrical Engineer and subject matter expert for 0732.50

**SCL Construction Guideline U10-7 (canceled)**; “Requirements for Transformer Pads and External, Below-Grade Transformer Service Vaults, Looped Radial System”

**SCL Construction Standard 0230.03**; “Requirements for Pad Mounted Termination Enclosure Installations”

---

## Oil Containment Systems



---

### 1. Scope

This standard covers the oil containment system requirements for transformers that are mounted at-grade or on a pad in the Seattle City Light (SCL) distribution system.

---

### 2. Application

This standard provides customers with the requirements for oil containment systems.

An oil containment system shall be installed to support every oil-filled padmounted transformer.

---

### 3. Industry Standards

Oil containment systems shall meet the applicable requirements of the following industry standard:

**Code of Federal Regulations (CFR)**, Title 40, Chapter 1, Subchapter D, Part 112, Subpart A, 112.7 General Requirements for Spill Prevention, Control, and Countermeasure Plans

---

### 4. General Requirements

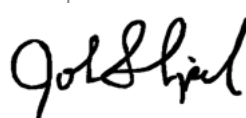
The customer shall design, install, and maintain the oil containment system to contain any and all oil spilled by the transformer. The customer shall design the system to meet the requirements of 40 CFR 112.7 with the following clarification: oil containment is required for all oil-filled transformers of any capacity. All transformer pad penetrations shall be sealed.

---

Standard Coordinator  
Brett Hanson



Standards Engineering Supervisor  
John Shipek



Division Director  
Darnell Cola



Any oil solidification media must be designed to work with the esterified vegetable oil that is used in City Light padmount transformers.

## 5. Capacity Requirements

The system shall contain all spilled oil and all oil-contaminated rainwater until cleanup. Transformer oil capacity will be communicated by SCL during the design process. Since this containment system is subject to rain and snow accumulation, provisions shall be made to handle water runoff.

## 6. System Review

The oil containment system design shall be designed and stamped by a qualified Professional Engineer licensed in the State of Washington and submitted to the SCL Electrical Service Representative (ESR) or Electrical Service Engineer (ESE) for review prior to construction.

The SCL ESR or ESE shall submit the design to the SCL Environmental Review Project Lead for review. The SCL Environmental Review Project Lead shall consult with the Environmental and Civil Engineering Leads for Spill Prevention Control and Countermeasures (SPCC).

## 7. System Inspection

The customer shall notify the SCL ESR or ESE of the oil containment system installation schedule. SCL will inspect the oil containment system prior to transformer installation and liner cover, if applicable.

## 8. System Design Options

The oil containment system can potentially be constructed of any of the following products, another product designed for this outdoor purpose, or an alternate spill prevention system listed in 40 CFR 112.7(c)(1):

- Oil water separator
- Impervious barriers with Solidification Products International, Inc. (SPI) Petro-Pipe or Justrite HFF Oil Stop Valves on the outlets. See Figure 8a.
- Containment blankets made with Basic Concepts Geomembrane/Barrier Boom or SorbWeb Plus material. See Figure 8b.

If containment design is an at-grade basin, provide sufficient slope to prevent standing water. Maximum slope shall not exceed 2%.

**Figure 8a. SPI Petro-Pipe and Justrite HFF Oil Stop Valve**



**Figure 8b. Basic Concepts Geomembrane/Barrier Boom or SorbWeb Plus Blankets**



---

## 9. System Maintenance

The customer shall conduct periodic maintenance on the system to ensure adequate secondary containment.

---

## 10. Sources

**Garcia, Larry**; SCL Environmental analyst and subject matter expert for 0735.50

**Hamlin, Pam**; SCL Engineer and subject matter expert for 0735.50

**Hanson, Brett**; SCL Engineer and originator of 0735.50

**Customer Requirements, In-Building Transformer Vaults,  
Network and Looped Radial Systems**



**1. Table of Contents**

1. Table of Contents.....	1
2. Scope .....	2
3. Application.....	2
4. Conflict .....	2
5. Accessibility .....	3
6. Location .....	4
7. Construction (Walls, Roof, and Floors).....	6
8. Doorways and Openings .....	7
9. Ventilation .....	8
10. Drainage .....	10
11. Pipes and Ducts .....	11
12. Storage in Vaults .....	11
13. Sprinkler Systems .....	11
14. Heat Sensors.....	11
15. References .....	11
16. Sources .....	11

Standard Coordinator  
Brett Hanson

Standards Engineering Supervisor  
John Shipek

Division Director  
Andrew Strong

## 2. Scope

This standard provides the requirements for Seattle City Light (SCL) Network and Looped Radial (formerly URD) transformer, in-building vaults. These vault rooms contain SCL owned or maintained equipment.

Network-ready vaults shall meet Network vault requirements.

An in-building transformer vault is a special room inside a building in which oil-filled transformers and related electric power distribution equipment are housed.

Concurrent vault requirements are listed in SCL 0751.60. Topics include vault grounding, lighting, ducts, cables, bus ducts, etc. SCL 0751.60 also lists required customer submittals and SCL provided project-specific requirements.

Electrical vaults within buildings that contain equipment owned and maintained by others are not covered by this standard.

---

## 3. Application

An in-building vault is required if the customer's electrical load exceeds the limits listed in Requirements for Electrical Service Connection, Table 5-1 and the customer cannot provide exterior space for the installation of SCL transformers and associated equipment on the project premises.

Vault requirements unique to either Network or Looped Radial (URD) systems are clearly indicated. All other requirements are applicable for both Network and Looped Radial systems.

This standard is intended for use by customers and SCL engineering, customer service, inspecting, reviewing, and operations personnel

---

## 4. Conflict

Where conflict exists between SCL requirements, the following order of precedence shall apply:

1. Project specific Customer Requirements Package, including the Service Construction Letter and Drawing
2. SCL 0751.00
3. Seattle Building Code, 2006, Section 422 (within the City of Seattle)
4. SCL 0751.60
5. Other SCL construction guidelines or construction standards
6. Other industry standards



## 5. Accessibility

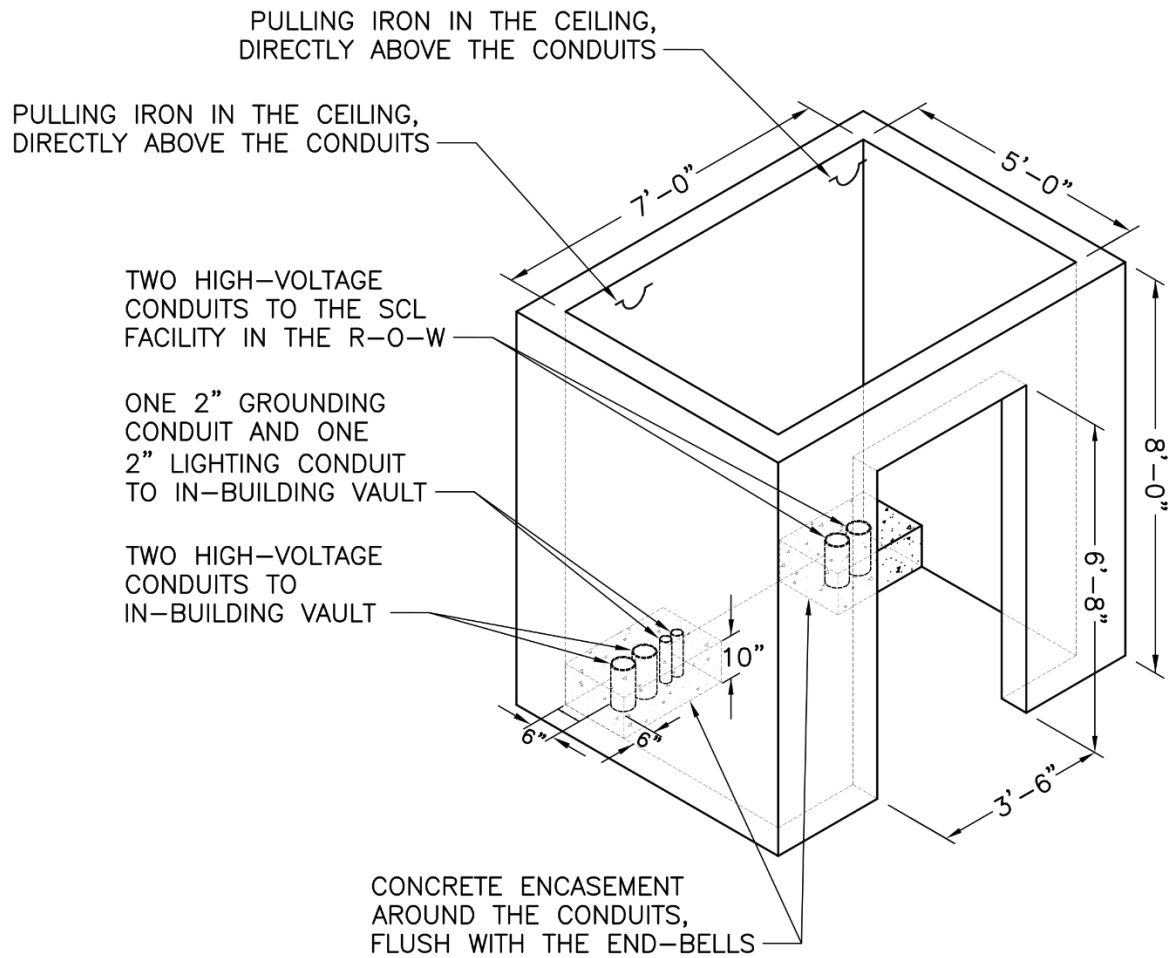
- 5.1 Seattle City Light prefers that SCL trucks be able to access the door or hatch of the in-building vault. Looped Radial equipment hatches shall be outside of the in-building vault.
- 5.2 In-building vaults shall be located no more than one floor below the building's exterior finished grade.
- For a Network or Network-ready vault located such that it is not readily accessible for the oil servicing hose and the 12-foot-tall oil pump van, a 6-inch diameter oil hose access to the in-building transformer vault shall be installed for use by SCL crews. The oil hose access shall be routed exterior to the in-building vault and provide a maximum hose length distance of 75 feet from the vault to an area accessible to the oil truck. The openings shall be located near the equipment access and the customer is responsible for grouting and waterproofing around the opening. Location shall be coordinated with SCL prior to construction.
- 5.3 Network: One or more door(s) or ceiling hatch shall be provided for every in-building vault.
- 5.4 Looped Radial (formerly referred to as URD): One or more door(s) shall be provided for every in-building vault.
- 5.5 The opening shall be adequate in size to permit the installation and removal of the equipment located in the vault.
- 5.6 The door access shall be kept unobstructed at all times.
- 5.7 An unobstructed level area shall be provided at the entrance to the in-building vault.
- 5.8 The level area shall be large enough for moving SCL equipment into and out of the in-building vault.
- 5.9 All in-building vaults shall be readily accessible to SCL personnel at all times.
- 5.10 If it is necessary to pass through locked doors to reach the in-building vault, keys for those locked doors shall be kept in a readily accessible key box near the first locked door. A spare set shall also be provided. Keybox shall be recessed into concrete wall to deter theft.
- 5.11 Non-SCL personnel shall not enter the in-building vault without SCL personnel after the vault has been accepted by SCL.
- 5.12 There shall be a permanent, clear equipment access path between the vault and the building exterior or right-of-way.
- 5.12.1. Sufficient horizontal and vertical clearance shall be provided for electrical equipment and machinery to move the equipment without interrupting other energized equipment. See SCL 0751.77.
- 5.12.2. The path floor shall be smooth, without seams or ridges or pads.
- 5.12.3. Customer shall move transformers to in-building vault. See Section 5.13.
- 5.12.4. The path floor shall be designed to support the weight of the electrical equipment and machinery to move the equipment. Transformers can weigh up to 30,000 pounds and have dimensions up to 12 feet long by 8 feet wide by 9 feet tall.
- 5.13 Equipment transportation agreement is required for in-building vaults. An equipment transportation agreement makes the property owner responsible for moving equipment between the right-of-way and the in-building vault.

The property owner shall sign a legally binding Equipment Transportation Agreement that will be attached to the property title. The Agreement requires the building owner to move transformers and vault equipment, including switches, into and out of the building, to and from the transformer vault, to a mutually agreed upon location on, or in the vicinity of, the owner's property from which SCL is able to deliver or pick up the transformers using normal transporting methods and equipment. Any damage that occurs to the transformers during transportation by the building owner and any additional expense incurred as a result of damage shall be paid by the building owner. A copy of the agreement shall be included in the vault document enclosure, see 0751.60 Section 14. Install Equipment Transportation Agreement sign, see SCL 7651.25.

## 6. Location

- 6.1 In-building vaults shall be located such that they can be ventilated to the outside without using ducts, if practical.
- 6.2 In-building vaults shall be dry and not subject to running, standing, flooding, or infiltration of water.
- 6.3 Exact location of in-building vault shall be determined for each specific project.
- 6.4 If the in-building transformer vault is located below grade level, an above-grade pulling vault is required to help prevent water intrusion.
- Above-grade pulling vault shall be accessible. See Section 5 Accessibility.
- Vault shall be a minimum of 5 feet deep by 7 feet wide by 8 feet tall. If the vault is used to connect to a high-voltage switch in the building or contains multiple feeders, additional space shall be required. Confirm dimensions with City Light engineer.
- Vault walls shall be concrete or concrete filled CMU. See Section 7 Construction.
- Vault door shall be 42 inches wide by 80 inches tall per SCL Standard 0751.49. The door shall be able to swing open 120 degrees.
- Install a UV-resistant sign on the exterior side of the door, stating "DO NOT BLOCK DOOR". Sign shall be a red phenolic resin sheet 6 mils thick with white one inch tall lettering.
- Install pulling irons opposite to, and centered on, the incoming conduits per SCL NCI-62. See Section 4 of SCL NCI-62 for ceiling design requirements.
- Primary conduits shall enter the vault through the floor and shall extend 10 inches above the floor.
- A two-inch conduit shall be routed from the vault to the in-building transformer vault for utility equipment grounding. Conduit bends shall be rigid galvanized steel.
- Conduits penetrating the floor shall be rigid galvanized steel and encased in a house-keeping pad with end bells flush with the top of the pad. See Figure 6.4 below. End bells shall meet SCL 7055.09. Encasement shall not protrude into the door passageway.

**Figure 6.4 Above-Grade Pulling Vault**



## 7. Construction (Walls, Roofs, and Floors)

- 7.1 Floors, walls, and ceilings of in-building vaults shall have a minimum three-hour fire resistance rating. All concrete surfaces shall be finished smooth.
- 7.2 All penetrations shall be sealed to be three-hour fire rated.
- 7.3 Network: The bottom 8 ft of wall, minimum, shall be solid concrete at least 6 in thick. Above the solid concrete wall, it may be solid concrete or concrete filled masonry units at least 6 in thick.
- 7.4 Floors and ceilings of in-building vaults shall be constructed of solid concrete at least 6 in thick.
- 7.5 Looped Radial (URD): Walls of in-building vaults shall be constructed of solid concrete or concrete-filled masonry units at least 6 in thick.
- 7.6 Network: Seismic anchors shall be embedded in the floor. See U10-5.3/NTP-40.
- 7.7 Steel support channels shall be embedded in the ceiling for ceiling-supported cable hangers per SCL 0257.06. For Looped Radial vaults, channel layout shall be parallel to the wall that the customer's service enters. For Network vaults, channel layout shall be determined by SCL for each specific project.
- 7.8 Pre-tensioned or post-tensioned concrete shall have the cable locations permanently marked with red epoxy paint on the surface of the concrete over the encased tendons.
- 7.9 In-building vault dimensions shall depend on the equipment and working clearances required. See SCL 0751.77.
- 7.10 The maximum ceiling height is 18 feet.
- 7.11 For working space for all equipment 600 V and under, see SCL 0751.77.
- 7.12 The vault floor shall be smooth, without seams, ridges, or pads. The floor shall slope toward the sump 1/2 inch for every 10 feet. Topping slabs and skim coats are prohibited.
- 7.13 Pulling Irons
- 7.13.1. Pulling iron(s) shall be installed per SCL NCI-62 opposite and centered on the primary cable duct bank entrance(s). Additional pulling irons may be required. All pulling irons shall be independently tested to verify strength.
- 7.13.2. Pulling irons shall have an ultimate (breaking) strength of 10,000 lb.
- 7.13.3. Pulling irons shall provide a minimum 3-in diameter round gap for hook or shackle attachment.
- 7.13.4. For Looped Radial vaults with a six foot or wider equipment access doorway, provide an additional pulling iron. Pulling iron shall be located opposite and centered on the doorway and meet SCL NCI-62.

## 8. Doorways and Openings

### 8.1 Doorways

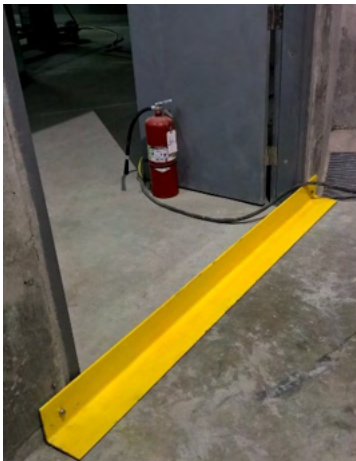
- 8.1.1. Looped Radial (URD): SCL requires an equipment access door. If equipment access is provided by a drop-in hatch outside the vault, a separate personnel door that permits egress through the building is required. The number of personnel access doors shall be determined for each specific project by SCL.
- 8.1.2. Network: SCL requires two doors for personnel egress; one of which may also be the equipment access door.
- 8.1.3. Personnel access doorways shall be at least 3 ft 6 in wide and 6 ft 8 in high.

### 8.2 Doors, Frames, and Door Hardware

- 8.2.1. For all door, frame, and door hardware requirements, see SCL 0751.49.

### 8.3 Sills

- 8.3.1. All in-building vault doorways shall have a removable oil containment sill of 6 in (minimum).
- 8.3.2. The sill shall be made of 6-in angle iron and painted safety yellow. The sill shall extend past door frame 6 inches.



- 8.3.3. The sill shall be installed behind each door and be connected to the wall with flush mount internal-threaded anchors. See SCL 7801.10.
- 8.3.4. The sill shall be installed after the installation of the electrical equipment and prior to energization.
- 8.3.5. The sill shall be sealed to the floor and wall with oil-resistant caulk.

### 8.4 Equipment Installation, Access, and Removal

- 8.4.1. Equipment access doorways shall be sized to accommodate the installation and removal of electrical equipment (including the installation machinery).
  - 8.4.1.1. If vault contains single phase transformers only, the doorway shall be at least 3 ft 6 in wide and 6 ft 8 in high.
  - 8.4.1.2. All other doorways shall be sized by SCL, as needed.

## 9. Ventilation

- 9.1 Ventilation systems shall be provided to dispose of heat from transformer total losses without creating a temperature rise that exceeds the transformer rating.
- 9.2 The owner is responsible for maintaining the vault ventilation system to ensure proper and continued operation.
- 9.3 Method of ventilation
- 9.3.1. Utility in-building vaults shall be mechanically ventilated.
- 9.3.2. Positive or negative pressure ventilation systems shall supply air for in-building vaults.
- 9.3.3. Ventilation system shall supply a minimum of 1.6 cfm of air per kVA of transformer capacity. SCL may require ventilation system to be independently tested and verified to meet requirements at contractor's expense.
- 9.4 Location
- 9.4.1. Exhaust ventilation openings and duct terminations shall be located a minimum of 9 ft above adjoining grade and finished walking surfaces. Exhaust openings and duct terminations shall be located a minimum of 10 feet from fire escapes, means of egress, combustible materials, any doors (except SCL doors), windows, or openings, and property lines. Confirm additional exhaust clearances with the Authority Having Jurisdiction.
- 9.4.2. Exhaust outlets shall be located on the exterior of the building.
- 9.5 Arrangement (of ventilation equipment)
- 9.5.1. Fans and thermostats
- 9.5.1.1. The in-building vault ventilation fans shall be installed outside of the vault.
- 9.5.1.2. The in-building vault ventilation fans shall be controlled by thermostats located inside the vault.
- 9.5.1.3. Remote temperature controller shall be installed.
- 9.5.1.4. A dedicated thermostat will activate the fans at 70 degrees F.
- 9.5.1.5. The second dedicated thermostat will turn off the fans at 140 degrees F.
- 9.5.1.6. Thermostats shall be analog (dial) type (Honeywell T631A-C type Farm-O-Stat, Model No. T631A1022). Locate thermostats on an interior wall within 3 ft of an entry door, 5 ft above finished floor, and in dead air space. Confirm final location with SCL inspector prior to rough-in.
- 9.5.1.7. Looped Radial (URD)/Network-Ready: Install a combination visible/audible alarm (Edwards Signal 868STRR-N5) and connect it to a dedicated circuit. Install a sign outside of the vault below the alarm that reads "If alarm operates, call Seattle City Light at 206-625-4448." See SCL 7651.25. If the ventilation system becomes inoperable or does not turn on at 70°F, or if the vault temperature exceeds 140°F, the visible alarm shall be configured to activate. Confirm with the inspector whether the audible alarm function is required.
- 9.5.1.8. Network: No visible or audible customer installed alarm required. SCL installs monitoring equipment.
- 9.5.1.9. The building owner is responsible for providing power and maintaining the vault ventilation system, including the fans.
- 9.5.1.10. Looped Radial (URD): The building owner may monitor vault fan alarm signal, but shall not control vault fan or alarm.

9.5.2. Vents

- 9.5.2.1. Intake air shall be drawn from an exterior air source such as the building exterior or garage. It shall not be drawn from conditioned air in the building.
- 9.5.2.2. Intake vents shall be located at least 18 in above the exterior floors.
- 9.5.2.3. The intake vents shall be located in the lower third of the interior walls of the vault. The bottom of the vent shall be located 18–24 inches above the finished vault floor.
- 9.5.2.4. The exhaust vents shall be as near to the ceiling as possible (in the upper third of the wall) or in the roof or ceiling of the vault.
- 9.5.2.5. Exhaust shall vent directly to the outside of the building or shall be ducted to the building exterior using three-hour-rated material.
- 9.5.2.6. Exhaust cannot vent to a covered parking area or garage.
- 9.5.3. The ventilation system shall cause air to flow across the cooling fins of the transformers. For each transformer rated 500 kVA and above, provide an intake vent mounted low behind the transformer
- 9.5.4. Ventilation system shall direct airflow uniformly across the vault.
- 9.5.5. The vault ventilation system shall be controlled independently of the building ventilation system.
- 9.5.6. No ducting shall be installed within the vault.
- 9.5.7. Vents shall not allow water to enter the vault.
- 9.5.8. Exhaust vents shall be 3 ft away from non-combustible surfaces and 10 ft away from combustible surfaces.

9.6 Ventilation Covering

- 9.6.1. Interior of vault face ventilation openings shall be covered with a 0.12-in diameter minimum metal gratings with 1/2-in maximum mesh openings to prevent rodent intrusion. Gratings shall be McNichols Wire Mesh 3658220041 or 3658220048 or equal with approval prior to rough-in. Grating shall be flush with wall.



- 9.6.2. Exterior of vault face ventilation openings shall be covered with fixed inverted V-shaped louvers that eliminate visual see-through and prevent rain from entering the vault. Louvers and frames shall be fabricated of 3/16-in thick (minimum) galvanized angle iron or equal with approval prior to rough-in. Louvers shall be supported and anchored to prevent unauthorized access to the vault. Any carriage bolts used shall be secured from within the vault.



- 9.7 Dampers
- 9.7.1. Intake vents in the vault walls shall have automatic closing fire dampers rated for three-hour fire resistance.
- 9.7.2. Damper actuating device shall function at 165°F. Any electrical dampers shall remain open for passive ventilation under normal conditions.
- 9.8 Ducts
- 9.8.1. If used, exhaust ducts shall have a three-hour fire resistance rating.
- 9.8.2. Exhaust ducts shall extend from the vault to the outside of the building.
- 9.8.3. Exhaust ducts shall be used exclusively for vault ventilation.
- 9.8.4. No fire dampers shall be installed in exhaust ducts.

---

## 10. Drainage

- 10.1 Drains are prohibited in all in-building transformer vaults.
- 10.2 Sumps
- 10.2.1. All in-building vaults shall have a dry sump.
- 10.2.2. Network and Network-Ready: The sump shall have a minimum capacity of 8 cubic ft.
- 10.2.3. Looped Radial (URD): The sump shall have a minimum capacity of 2.25 cubic ft.
- 10.2.4. Sumps shall have an opening with 18 in minimum in both length and width and have a depth of at least 12 in.
- 10.2.5. Sumps shall be equipped with a removable galvanized steel grate that is flush with the floor and capable of supporting 400 lb.
- 10.2.6. Sumps shall have a grouted bottom. Construction shall include typical vault floor of 6-in-thick concrete.
- 10.2.7. At least one sump shall be located near the personnel door but not in the equipment access path or in front of the door.



10.2.8. The floor shall slope at least 1/2 inch in ten ft towards the sump.

### 11. Pipes and Ducts (Water Pipes and Accessories)

- 11.1 No pipes or foreign ducts shall pass or enter the in-building vault.
- 11.2 Electrical conduits terminating in the vault shall be sealed with a listed three-hour fire rated material.
- 

### 12. Storage in Vaults

- 12.1 No material shall be stored in any in-building vault.
- 

### 13. Sprinkler Systems

- 13.1 Sprinkler systems shall not be installed within an in-building vault.
- 13.2 In-building vaults shall be maintained in a dry condition.
- 

### 14. Heat Sensors

- 14.1 If used, heat sensors shall be located near the door, away from electrical penetrations and equipment. All conduit and associated boxes shall be embedded in the concrete structure. Confirm locations with the inspector prior to rough-in.
- 14.2 The sensor shall be able to be tested from outside the vault without an SCL standby.
- 

### 15. References

**SCL Construction Standard 0257.06**; "Ceiling Channel for In-Building Vaults"  
**SCL Construction Standard 0751.49**; "In-Building Transformer Vault Doors"  
**SCL Construction Standard 0751.60**; "Concurrent Customer Requirements for In-Building Transformer Vaults"  
**SCL Material Standard 7651.25**; "Customer Requirements for Vault Signage"  
**NFPA 70 - NEC**; National Electrical Code; 2008  
**Requirements for Electric Service Connection (RESC)**; Seattle City Light, Rev. August 2020  
**Seattle Building Code**; Section 422; 2006

---

### 16. Sources

**Hanson, Brett**; SCL Standards Engineer and subject matter expert for 0751.00  
**Edwards, Tommy**; SCL Electrical Reviewer and subject matter expert for 0751.00  
**SCL 2007-2008 In-Building Vault Subcommittee**: Shayan Arya, Ed Chu, Toni Gamble, Laurie Hammack, Bob Hansen, Gerard Legall, Eivind Perander, Uzma Siddiqi, Quang Ta, and Roger Tapp  
**SCL Construction Guideline U2-8** (canceled); "In-Building Transformer Vaults (Non-Network Area)"  
**SCL Construction Guideline U10-2** (canceled); "Transformer Service Vaults and Padmounts, Customer's Responsibility, Outside Network Area"

**SCL Construction Guideline U10-2.1** (canceled); "Transformer Service Vault, In-Building, Dry, Outside Network Area"

**SCL Construction Guideline U10-2.2** (canceled); "Transformer Service Vault In-Building, With Outdoor, Below Ground Access, Outside Network Area"

## In-Building Transformer Vault Doors



### 1. Scope

This standard details the performance and hardware requirements for in-building vault doors.

### 2. Application

This standard applies to all new and retrofit doors for vaults in the Network and Looped Radial systems. This standard will be used by building owners and their contractors as well as Seattle City Light (SCL) engineers, crews, and inspectors.

### 3. Industry Standards

Vault doors shall meet the applicable requirements of the following industry standards:

**ANSI/BHMA A156.3-2008**; Exit Devices

**ANSI/BHMA A156.4-2014**; Door Control-Closers

**NFPA 80**; Standard for Fire Doors and Other Opening Protection

**UL 10C**; Standard for Positive Pressure Fire Tests of Door Assemblies

**UL 1784**; Air Leakage Tests of Door Assemblies

Standards Coordinator  
Brett Hanson

Standards Supervisor  
John Shippek

Unit Director  
Darnell Cola

#### 4. Definitions

**Active leaf or active door** – the door in a double-door assembly that is actively used. The active leaf contains the lock and door handle.

**Astragal** – a molding or strip whose purpose is to cover or close the gap between the edges of a pair of doors. The astragal can help prevent lock picking.

**Construction core** – a small format, interchangeable core for temporary use prior to vault acceptance when a permanent core will be installed.

**Coordinator** – a device used on a pair of doors to ensure that the inactive leaf is closed before the active leaf. A coordinator is necessary when an astragal is present on a set of double doors and an exit device is installed on the inactive door.

**Dogged / dogging** – manually securing the crash bar in the unlocked position from inside the room.

**Inactive leaf or inactive door** – the door in a double-door assembly that does not contain a lock, but is bolted when closed, and to which the strike is fastened to receive the latch or bolt of the active door.

**Leaf** – each of the two doors that make up a double-door assembly.

**Storeroom function** – door hardware is always in locked position and opening requires a key.

---

#### 5. General Requirements

##### 5.1 Doors and Frames

All doors shall be NFPA 80 Class A and have a 3-hour fire rating and be compatible with the installed hardware. In-building vault doors shall not have any vents or other types of openings. All doors shall be painted to prevent corrosion.

All single doors shall swing out 120 degrees from the vault opening. All double doors shall swing out 180 degrees from the vault opening. Door swing shall be protected by bollards if vehicles or mobile equipment could enter the door swing area.

In an existing vault where new hardware is being installed in a reused door, cover unused holes with material that maintains the fire rating and security requirements outlined in this standard and satisfies the requirements of the Authority Having Jurisdiction (AHJ).

Head and jamb frame throats shall be treated with a bituminous coating. Frame cavity shall be filled with grout.

##### 5.2 Door Hardware

###### 5.2.1. Hinges

Hinges shall be extra heavy-weight steel or stainless steel with bearings and non-removable pins. Furnish and install a minimum of one hinge for every thirty inches of door height.

Hinges shall be one of the following products or an equal approved by SCL prior to construction:

- McKinney T4A3786 4-1/2 x 4-1/2 NRP US26D (steel for interior conditioned spaces)
- McKinney T4A3386 4-1/2 x 4-1/2 NRP US32D (stainless steel for exterior and unconditioned spaces)

### 5.2.2. Locks

Locks shall be ANSI A156.3-Grade 1, fire-rated exit devices.

Mortise-type locks shall be used for single doors.

Mortise-type locks shall be used for the active leaves of door pairs. Surface vertical rod-type locks shall be used for the inactive leaves of door pairs.

Double-door assembly shall include overlapping astragals, coordinators, and carry bars.

For 7-ft high doors, there shall be one guide for the bottom rod and one guide for top rods. For doors over 7 ft high, there shall be one guide for the bottom rod and two guides for top rods.

The pull side trim shall be a pull type. On pairs, only the active leaves shall have pull trim. Doors shall be equipped with panic bars that are normally latched but open under simple pressure, never binding.

For larger doors, supply Grade 1 fire-rated exit devices that are listed for use with those door dimensions. Confirm manufacturer and product numbers prior to ordering.

Locks shall be one of the following products or an equal Grade 1 lock approved by SCL prior to construction:

#### Single doors

- Sargent 12-8904 (x MAL or 824 pulls) 72-41 US32D (storeroom function locks with anti-pick function). Single door locks shall be kept locked at all times.

#### Door pairs

- Sargent 12-8904 72-41 US32D (x MAL or VRT26 Rockwood pulls cut short on edge for fit with astragal) for active leaves (storeroom function locks with anti-pick function). Door pair locks shall be kept locked at all times.
- Sargent 12-8710 (exit only, no pulls) US32D. This lock shall be used for inactive leaves.

Construction cores shall be furnished and installed by the building owner prior to vault acceptance. The owner shall provide adequate keys (two minimum) for the construction phase.

Permanent cores, SFIC 7-Pin Best type, will be supplied and installed by SCL.

### 5.2.3. Door Closers

Door closers shall be ANSI A156.4-Grade 1, parallel arm application with heavy duty rigid arms.

Door closers shall be one of the following products or an equal approved by SCL prior to construction:

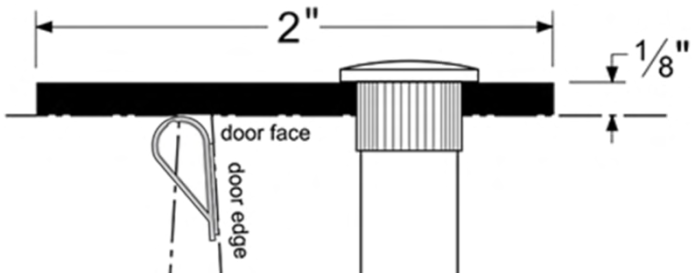
- Norton PR7500 689
- Sargent 351-P10 EN (25-year warranty)

### 5.2.4. Astragals

Overlapping astragals are required on the active leaf of pairs.

Astragals shall be Pemko 357SP or an equal approved by SCL prior to construction. See Figure 5.2.4.

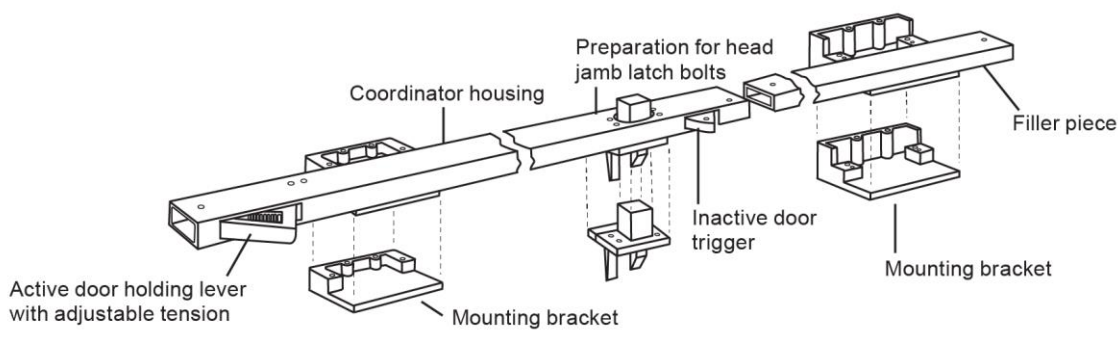
**Figure 5.2.4. Astragal**



**5.2.5. Coordinators**

Door coordinators shall be installed for all door pairs. Soffit plates shall be attached. Soffit plates shall be Rockwood 2601 AB or C soffit plate brackets or an equal approved by SCL prior to construction. See Figure 5.2.5.

**Figure 5.2.5. Door Coordinator**



Coordinators shall be one of the following products or an equal approved by SCL prior to construction:

- Rockwood 2600 Series with wear plates on door faces
- Rockwood 2672 for doors with a 72-in opening width

**5.2.6. Carry Bars**

Carry bars shall be installed for all door pairs. Carry bars shall be Rockwood 1100 or an equal approved by SCL prior to construction. See Figure 5.2.6.

**Figure 5.2.6. Carry Bar**



**5.2.7. Wall Stops**

Wall stops shall be installed where necessary to cushion the contact between trim and the wall. Wall stops are not required for doors without pull side trim. For example, wall stops are not required for the door leaf of a pair that does not have trim. Wall stops shall be Rockwood 400 US26D or an equal approved by SCL prior to construction.

### 5.2.8. Gasketing

Gasketing shall be provided including self-adhesive backing on frame stops and the edge of active leaves of pairs. Gasketing shall be fire rated in accordance with UL 10C and smoke tested in accordance with UL 1784. Gasketing shall be Pemko S88D or an equal approved by SCL prior to construction.

---

## 6. Testing and Acceptance

### 6.1 Single Door Testing

The following functionality will be tested and confirmed by SCL prior to vault acceptance:

- Small format interchangeable cylinder, 7-pin is installed
- Lockset installed is Storeroom Function and always in the locked position
- Crash bar allows free egress and is never binding
- Door closer pulls the door to latch every time from every position
- Anti-pick function of the lock works
- Panic hardware dogging function is not installed
- Daylight is not visible around the door when the door is closed from the inside of the room

### 6.2 Double Door Testing

The following functionality will be tested and confirmed by SCL prior to vault acceptance:

- Small format interchangeable cylinder, 7-pin, is installed
- Lockset installed is Storeroom Function and always in the locked position
- Crash bar allows free egress and is never binding
- Door closer pulls the door to latch every time from every position
- Anti-pick function of the lock works
- Panic hardware dogging is not installed
- Daylight is not visible around the door when the door is closed from the inside of the room
- Vertical rods are adjusted properly so that they:
  - Drop deep enough to catch and hold.
  - Retract high enough for a smooth, safe exit.
- Door coordinator functions regardless of which door is used to exit, and the carry bar is installed properly
- Astragal does not prevent exiting from fixed leaf

---

## 7. References

**SCL Construction Standard 0751.00**; "Customer Requirements, In-Building Transformer Vaults, Network and Looped Radial System"

---

## 8. Sources

**Hanson, Brett**; SCL Standards Engineer, subject matter expert, and originator of 0751.49 (brett.hanson@seattle.gov)

---

## Concurrent Customer Requirements, In-Building Transformer Vaults

---

### Table of Contents

1. Scope .....	1
2. Application .....	1
3. Conflict .....	2
4. SCL Project-Specific Requirements .....	2
5. Other Agency Requirements .....	2
6. Required Customer Submittals .....	3
7. SCL Inspections .....	3
8. Easements .....	3
9. General Requirements .....	4
10. Vault Grounding .....	5
11. Vault Lighting .....	6
12. Vault High Voltage (Primary) Entrance .....	6
13. Customer's Service Connection .....	8
14. Vault Document Enclosure .....	8
15. Requirements of Other Utilities .....	9
16. References .....	9
17. Sources .....	9

---

### 1. Scope

This standard covers requirements for in-building transformer vaults. The topics addressed are listed in the Table of Contents above.

This standard shall be used in conjunction with Seattle City Light (SCL) 0751.00 which states and discusses other requirements, including Accessibility, Location, Construction (Walls, Roof, and Floors), Doorways and Openings, Ventilation, Drainage, Pipes and Ducts, Storage in Vaults, and Sprinkler Systems.

Network-ready vaults shall meet Network vault requirements.

This standard does not apply to in-building vaults that contain switchgear.

---

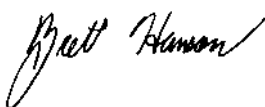
### 2. Application

This standard lists the SCL requirements for in-building vaults. An in-building vault is required if (1) the customer's electrical load exceeds the limits listed in *Requirements for Electrical Service Connection*, Table 3.3, and (2) the customer cannot provide exterior space for the installation of SCL transformers and associated equipment of the project premises.

This standard is for use by customers and SCL engineering, customer service, inspection, review, and operations personnel.

---

Standard Coordinator  
Brett Hanson



Standards Engineering Supervisor  
John Shipek



Division Director  
Andrew Strong





### 3. Conflict

Where conflict exists the following order of precedence shall apply:

1. Project-specific Customer Requirements Package, including the Service Construction Letter and Drawing
2. SCL 0751.00
3. Seattle Building Code, 2006, Section 422 (within the city of Seattle)
4. SCL 0751.60
5. Other SCL construction standards
6. Other industry standards

---

### 4. SCL Project-Specific Requirements

When necessary, Seattle City Light Engineering will provide the following project-specific requirements for in-building vaults:

- 4.1 Minimum vault dimensions, including the height of ceilings
- 4.2 Direction and location of ceiling channel
- 4.3 Location and number of vault pulling irons
- 4.4 Locations for transformer seismic anchors
- 4.5 Locations and number of ground rods
- 4.6 Location, size, and number of doors
- 4.7 Required air flow for vault ventilation (in CFM)
- 4.8 Location and type of customer's service connection (Service Entrance)
- 4.9 Routing of high voltage conduit from the SCL distribution system to the customer's in-building vault, including conduit on poles

---

### 5. Other Agency Requirements

- 5.1 Before a customer can be connected to the SCL electrical system, the building electrical system must pass electrical inspection by the Authority Having Jurisdiction. (Refer to the agency issuing the electrical permit.)
- 5.2 The customer is responsible for the in-building vault to satisfy applicable laws, ordinances, and requirements regarding sound and vibration levels. (Refer to the Washington Administrative Code, King County Ordinances, and city ordinances.)

## 6. Required Customer Submittals

In addition to the submittals required in the SCL Application for Electric Service packet, the following submittals must also be received and approved by SCL before construction of the in-building vault room:

- 6.1 The customer's in-building ventilation system shall be designed by a qualified HVAC consultant.
- 6.2 The customer shall submit drawings showing the design of the in-building vault ventilation system, including intake and exhaust, fans, louvers, dampers, thermostats, air flow direction, etc. Location of all devices and apparatus shall be shown on a plan drawing.
- 6.3 All topics addressed in the SCL project-specific requirements section shall be shown on customer drawings of the in-building vault room.

---

## 7. SCL Required Points of Inspection

Before a customer can be connected to the Seattle City Light electrical system, Seattle City Light personnel must inspect and approve the following items:

- Vault Construction per SCL Construction Requirements Package and SCL Construction Standards
- Grounding:
  - Grounding resistivity shall be 25 ohms or less
  - Exothermic welds, if any, before they become inaccessible
  - Ground cable routing
- Duct Bank Installation: trenching, bedding, conduit installation, encasement, and backfill
- Conduits: cleaning, mandreling, and pull tape installation
- Vault construction, including pulling irons, ceiling channel, seismic embeds, ventilation, and alarm operation
- Other inspections by SCL

Customer shall contact SCL to schedule inspection a minimum of (5) business days prior to inspection.

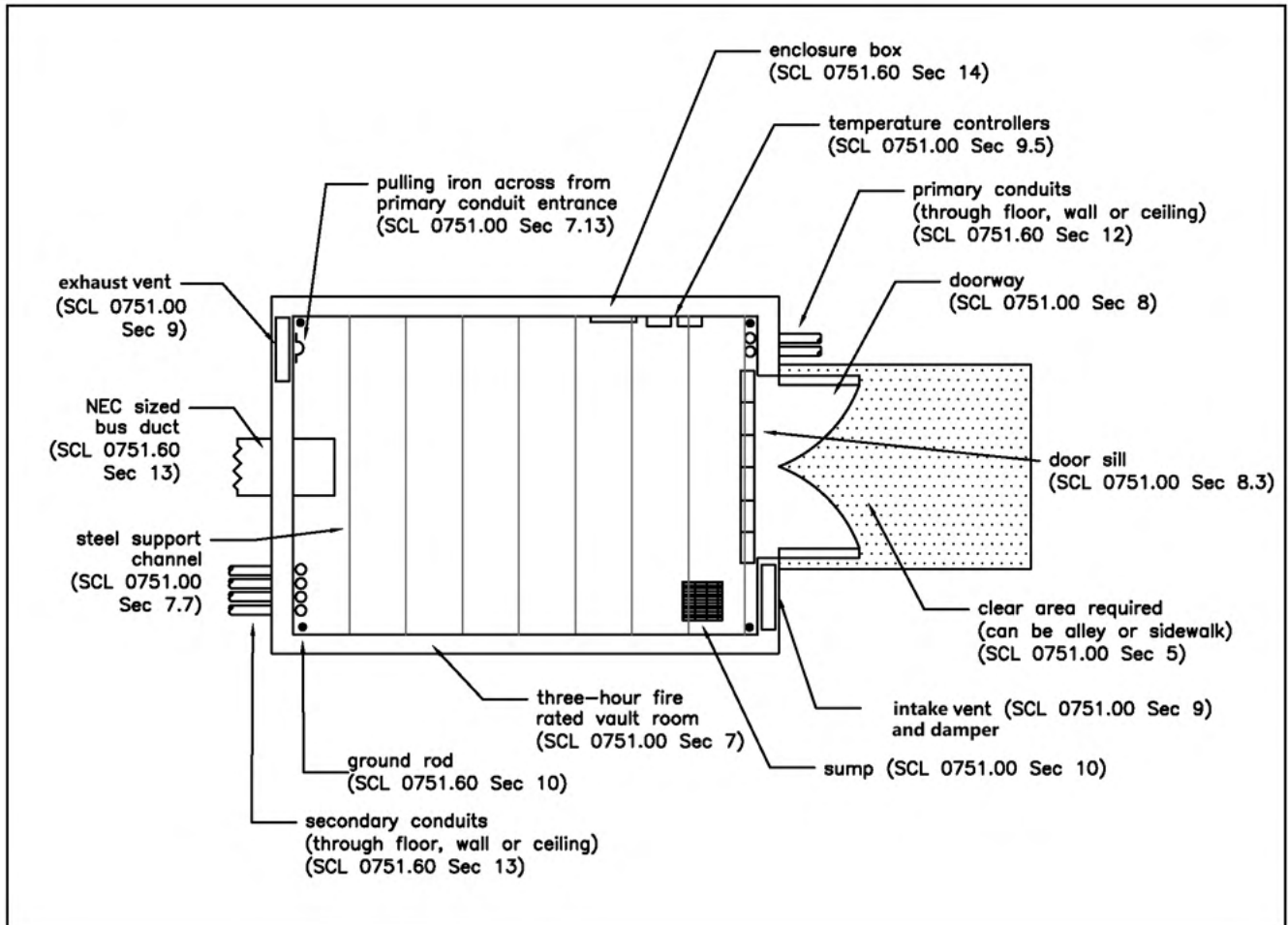
---

## 8. Easements

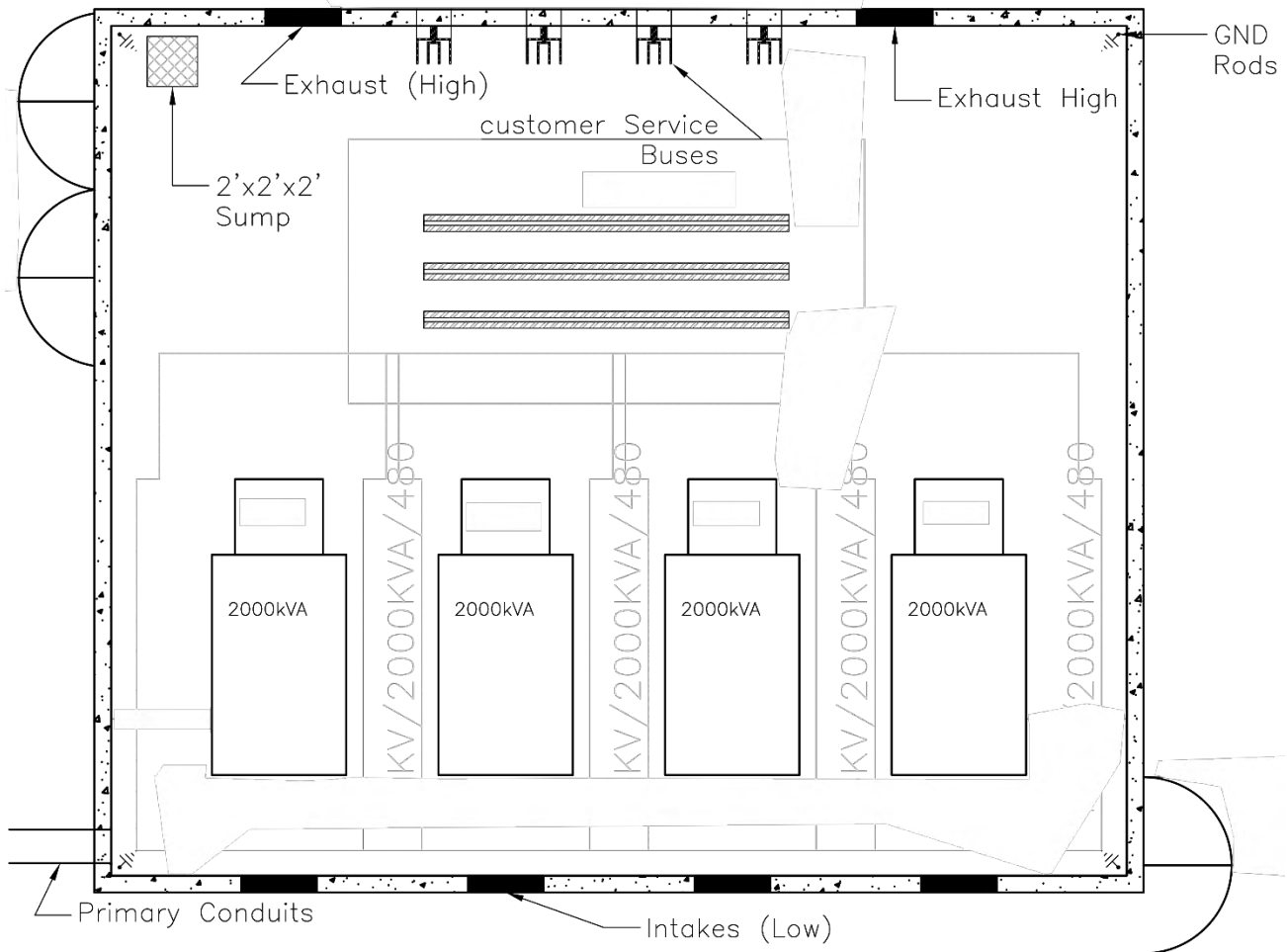
- 8.1 Seattle City Light requires an easement if SCL equipment is needed to serve more than one parcel and that equipment is located on private property. In that case, an easement is required over the entire area in which the SCL distribution system will be located.
- 8.2 If required, a new easement must be secured, or the customer shall provide proof of an existing easement to Seattle City Light before the service will be connected.
- 8.3 The easement document is prepared separately from the project-specific Customer Requirements Package.

**9. General Requirements**

**Figure 9a. Preferred Layout for a Looped Radial In-Building Transformer Vault**



**Figure 9b. Preferred Layout for a Network In-Building Transformer Vault**



- 9.1 In-building vaults shall be dry spaces, and no standing water shall accumulate in the vault. The customer shall take adequate measures to prevent water from entering the in-building vault via wall, floor, or ceiling penetrations or via seepage. It is the responsibility of the customer to maintain the vault as a dry space.
- 9.2 The vault is not to be used for any other purpose except for SCL electrical distribution equipment.
- 9.3 The vault shall conform to the requirements of Figure 9a or Figure 9b.

**10. Vault Grounding**

- 10.1 General Requirements
  - 10.1.1. A driving head shall be used to prevent damage to the ground rod threads.
  - 10.1.2. The space between the rods and the floor shall be caulked and grouted to prevent the entrance of water.
  - 10.1.3. The grounding electrode system shall be constructed to ensure it has a resistance to ground of 25 ohms or less prior to connecting the neutral or service. SCL shall test to confirm compliance. If the electrode system does not result in a resistance to ground of 25 ohms or less, inform SCL engineer. SCL shall advise additional grounding measures required.

- 10.2 Vaults with Floor Contacting Soil
- 10.2.1. Grounding for the vault shall consist of four, 5/8 inch by 8-foot copper-clad steel ground rods (Stock No. 564238 or equal) driven into compacted soil near the corners of the vault at least 16 ft apart. See SCL 6762.25.
  - 10.2.2. Each rod shall be placed 6 inches (plus/minus 1/2 inch) from the walls. Confirm locations with inspector prior to rough-in. If this cannot be achieved due to building conflicts such as footings, provide alternative. Alternative ground rod location: Install ground rod within building footprint as close to corner as practical at least 16 feet from other ground rods. Install one 250 kcmil, 600 V insulated copper, soft-drawn, concentric-stranded conductor to vault corner. Conductor shall extend 6 ft into the vault and be exothermically welded to the ground rod.
  - 10.2.3. Rods shall extend 6 inches above the vault floor.
- 10.3 Vaults with Floor Not Contacting Soil
- 10.3.1. Grounding for the vault shall consist of four, 5/8 inch by 8 foot copper-clad ground rods, driven into compacted soil within 50 feet of the vault floor and within the building footprint. Exact location will be shown on project-specific drawing. Ground rod connections shall be by exothermic weld. See SCL 0468.90.
  - 10.3.2. Ground rods shall be spaced a minimum of 8 feet apart.
  - 10.3.3. Install one 500 kcmil, 600 V insulated copper, soft drawn, concentric-stranded conductor, to each pair of the ground rods. These two 500 kcmil conductors shall extend 6 feet into the vault from opposite corners. Each conductor shall be attached to each pair of ground rods with an exothermic weld.
  - 10.3.4. The two grounding conductors shall be kept 8 feet apart from each other and be electrically isolated from any other electrical ground cable and building steel.
  - 10.3.5. Outside the vault, the grounding conductors shall be embedded in the concrete building structure with a minimum of 4 inches of cover.

---

## 11. Vault Lighting

- 11.1 For Looped Radial vaults, the customer shall install vault lighting and receptacles per SCL 0674.06.
- 11.2 For Network vaults, SCL shall install vault lighting and receptacles.
- 11.3 SCL will connect the power for the lights and receptacles.
- 11.4 Confirm layout with inspector prior to rough-in.

---

## 12. Vault High Voltage (Primary) Entrance

- 12.1 General Requirements
  - 12.1.1. All conduit bends shall be rigid galvanized steel.
  - 12.1.2. Provide and install conduits from the customer vault to the utility's facility specified by the SCL engineer.

- 12.1.3. For Looped Radial vaults, provide and install conduits from the vault to the utility facility specified in the project-specific Customer Requirements Package. Install two 4-inch conduits with a maximum of 270 degrees of bends, unless otherwise specified in the project-specific Customer Requirements Package.
- 12.1.4. For Network vaults, a maximum of 180 degrees of bend is allowed in the primary conduit run.
- 12.1.5. After conduit installation, the conduit shall be cleaned and mandreled per SCL U2-11.40/ NDK-40.
- 12.2 Conduit in Right-of-Way and Easements
  - 12.2.1. Install and terminate below-grade conduit per SCL 0214.00 and 0222.02.
  - 12.2.2. If applicable, provide and install conduit risers on pole per SCL 0224.34. Exact location shall be included in the project-specific Customer Requirement Package.
- 12.3 Conduit on Private Property, including within the in-building vault
  - 12.3.1. Install below-grade conduit on private property per SCL 0222.02 and 0224.07.
  - 12.3.2. Starting at one foot outside the building and continuing into the vault, conduit shall be rigid galvanized steel conforming to SCL 7050.05. Conduits shall be isolated from building steel.
  - 12.3.3. Conduit shall be encased within a minimum of 6 in of concrete within building. Red dye shall be added at the equivalent of 4 lb of red oxide per cubic yard. Maximum aggregate size shall not exceed 3/8 in.
  - 12.3.4. If surface of concrete encased conduit bank is visible within building it must be visibly marked with permanent white retro-reflective paint, stating "DANGER-High Voltage Do Not Drill" signs over the concrete encased conduit bank's entire path within building to vault. Letters shall be 2 inches tall minimum. Install signs once per room and every 10 ft.
  - 12.3.5. High voltage or primary entrances into vaults are cables in conduits.
  - 12.3.6. Conduits entering the vault shall be supplied with closing plugs. See SCL 7345.7
  - 12.3.7. Conduit shall enter the vault perpendicular to the vault wall no more than 18 inches from the adjacent wall. Conduits shall be terminated flush to the wall.
  - 12.3.8. A minimum of 6 inches shall be required between the closest edge of the conduit and the adjacent ceiling or walls. A minimum of 18 inches shall be required between the closest edge of the conduit and the floor.
  - 12.3.9. Conduits entering the vault shall be provided and installed with end bells conforming to SCL 7055.09 and shall be grouted both inside and outside the vault per SCL U2-11.3/NDK-30.
  - 12.3.10. Conduits entering the same vault corner but on adjacent walls shall be staggered and shall not enter at the same elevation.
  - 12.3.11. Conduits entering through the floor shall extend 10 in above the floor.
  - 12.3.12. Conduits shall be effectively bonded prior to vault entry. Connect ground clamp (per SCL 6762.7) to a #2 AWG insulated copper bonding jumper and extend into the vault. Conductor shall extend into the vault and be long enough to reach the floor plus 5 feet of coiled conductor.

### 13. Customer's Service Connection (Service Entrance)

- 13.1 General Requirements
  - 13.1.1. Seattle City Light prefers that the customer provide NEC-sized bus duct into the in-building vault. NEC-sized cables in conduit are also acceptable.
  - 13.1.2. All service entrance penetrations shall be sealed, including bus duct, conduits, and cables.
  - 13.1.3. Rotation of service bus bars or cables shall be clearly identified by the customer and in case of multiple services, it shall be consistent across all services.
  - 13.1.4. Each service shall be labeled. Include the service ampacity, voltage, and phases. See 7651.25.
- 13.2 Service Entrance using Bus Duct
  - 13.2.1. Provide and install NEC-sized secondary bus duct into the vault per SCL 0474.08. Bus duct penetrations shall not exceed bus duct dimensions by more than 2 inches (width or height).
  - 13.2.2. Brace and support the bus duct.
  - 13.2.3. Label each bus bar for phasing.
  - 13.2.4. The bus duct is centered on the wall.
- 13.3 Service Entrance using Cables in Conduit
  - 13.3.1. Provide and install NEC-sized service conduits and cable from switchgear into vault per SCL 0473.50. For Network vaults, Customer shall furnish cable limiters. Conduit shall be rigid galvanized steel throughout the depth of the wall, floor, or ceiling. No more than 12 cables per phase or neutral are allowed. Grounding and bonding of conduits shall be external to the vault and is subject to inspection by the Authority Having Jurisdiction.
  - 13.3.2. Conduits entering the vault shall be supplied with closing plugs.
  - 13.3.3. Conduit shall enter the vault perpendicular to the vault wall, floor, or ceiling, no more than 18 inches from a corner.
  - 13.3.4. Conduits entering the vault shall be terminated with PVC end bells and shall be grouted both inside and outside the vault per SCL U2-11.3/NDK-30.
  - 13.3.5. Conduits entering the same vault corner but on adjacent walls shall be staggered and not enter on the same elevation.
  - 13.3.6. If conduit is entering through the floor, it shall extend 8–10 inches above the floor. Pour 4" concrete housekeeping pad flush to top of end bells. Chamfer corners and finish smooth. See SCL 7651.25.
  - 13.3.7. Label each cable to identify phasing.
  - 13.3.8. If multiple services, label each set of cables with the service being fed.
  - 13.3.9. Fire seal the cable installed in conduit for a three-hour rating using rockwool and rated grout or fire-barrier caulk in order to protect migration of fire, smoke, and gas.

---

### 14. Vault Document Enclosure

- 14.1 Install a permanent, weatherproof clear document enclosure box on the vault wall near the light switch or the thermostats.
- 14.2 The document enclosure shall be adequate for permanently storing 8-1/2 by 11-inch documents.

## 15. Requirements of Other Utilities

- 15.1 SCL construction standards and guidelines do not cover the installation of telecommunications or any other utility's equipment serving a project.
- 15.2 Seattle City Light does not coordinate with other utilities for installations in the public right-of-way.
- 

## 16. References

- SCL Construction Standard 0222.02**, "Requirements for Primary Conduits and Duct Banks"
- SCL Construction Standard 0224.07**; "Requirements for Secondary Conduit Installation"
- SCL Construction Standard 0224.34**; "Steel Conduit Risers"
- SCL Construction Standard 0468.90**; "Exothermic Connection System"
- SCL Construction Standard 0473.50**; "Looped Radial and Network Service Entrance Cables in Conduit"
- SCL Construction Standard 0474.08**, "Looped Radial and Network Dry Vault Service Entrance Bus Duct"
- SCL Construction Standard 0674.06**; "In-Building Vault Lighting and Receptacle Requirements, Looped Radial System"
- SCL Construction Standard 0751.00**; "Customer Requirements, In-Building Transformer Vaults, Network and Looped Radial Systems"
- SCL Construction Standard 0751.77**; "In-Building Vault Equipment Clearances"
- SCL Construction Guideline U2-11.3/NDK-30**, "Termination of Existing Ducts in New Vaults or Manholes"
- SCL Construction Guideline U2-11.40/NDK-40**; "Mandreling and Cleaning of Ducts and Conduits"
- SCL Material Standard 6762.25**; "Ground Rods, Copper-Covered, Sectional"
- SCL Material Standard 7050.05**; "Zinc-Coated Steel Conduit and Fittings"
- SCL Material Standard 7055.09**; "DB120, PVC Conduit Fittings"
- SCL Material Standard 7345.7**; "Fittings For Underground Use, PVC"
- SCL Material Standard 7651.25**; "Customer Requirements for Vault Signage"
- 

## 17. Sources

- Abbott, Jeremy**; SCL Electrical Reviewer and subject matter expert for 0751.60
- Edwards, Tommy**; SCL Electrical Reviewer and subject matter expert for 0751.60
- Hall, Alan**; SCL Engineer and subject matter expert for 0751.60
- NFPA-70**, National Electric Code (NEC); 2008 Edition, National Fire Protection Association, Quincy, MA, 2010
- Requirements for Electric Service Connection**; Seattle City Light
- SCL Construction Standard U2-10/NDK-50 (canceled)**; "Electrical Conduit and Facilities in Public Rights-of-Way"



**SCL Construction Guideline U2-8 (canceled);** "In-Building Transformer Vaults (Non-Network Area)"

**SCL Construction Guideline U7-10/NDK-70 (canceled);** "Conduit Risers on Poles"

**SCL Construction Standard U7-10.2/NDK-90 (canceled);** "Primary Conduit Riser Pole Base Detail"

**SCL Construction Guideline U10-2 (canceled);** "Transformer Service Vaults and Padmounts, Customer's Responsibility, Outside Network Area"

**SCL Construction Guideline U10-2.1 (canceled);** "Transformer Service Vault, In-Building, Dry, Outside Network Area"

**SCL Construction Guideline U10-2.2 (canceled);** "Transformer Service Vault In-Building, With Outdoor, Below Ground Access, Outside Network Area"

**SCL Construction Guideline U2-8 (canceled);** "In-Building Transformer Vaults (Non-Network Area)"

**SCL 2007-2008 In-Building Vault Subcommittee:** Shayan Arya, Ed Chu, Toni Gamble, Laurie Hammack, Bob Hansen, Gerard Legall, Eivind Perander, Uzma Siddiqi, Quang Ta, and Roger Tapp

**Siddiqi, Uzma;** SCL Standards Engineer, subject matter expert, and originator of 0751.60

## In-Building Vault Equipment Clearances



### 1. Scope

This standard covers the requirements for minimum working spaces around electrical equipment to be installed in Seattle City Light (SCL) Network and Looped Radial (URD) in-building vaults. This standard should be used to evaluate the site-specific equipment layout and size of in-building vaults.

### 2. Application

The intended audience for this standard is SCL engineers, electrical service engineers and representatives, and customer engineering consultants who are involved with the planning and construction of in-building vaults.

### 3. Discussion

SCL in-building vaults present arc flash and exposed live parts hazards to the crews that construct and maintain them. The purpose of this standard is to define working spaces for crews to perform work during three distinct phases of operation:

1. Initial vault construction
2. Periodic electrical equipment maintenance while the vault is energized
3. Major equipment maintenance or removal when the vault may or may not be energized

Acronyms used in this section include:

Acronym	Definition
CSB	Customer Service Bus (or bus duct)
WMB	Wall Mounted Bus
BTS	Bus Tie Switch
XFMR	Transformer (acronym used in tables but not in text)
IWCB	Integral Web Channel (or Collector) Bus
NP	Network Protector
HVAC	Heating Ventilation and Air Conditioning

### 3.1 Width of Working Space

Working space widths are summarized in Table 3.1. Distances are horizontal (regardless of elevation) and are given from the nearest edge of the equipment. This is because the CSB and WMB have exposed live parts on all sides.

If there are elevation changes within the vault that require stairs or landings, additional working space will be required.

**Table 3.1. Working Space Width (ft)**

	See Figure	CSB	WMB	Adjacent Wall	Column	HVAC Grille	Door	BTS	IWCB	Cables in Conduit	XFMR
<b>CSB</b>	3.3b, 3.3c	3	6	3	3	3	3	6	N/A	3	6
<b>WMB</b>	3.4b	6	N/A	6	6	3	6	6	N/A	4	6

### 3.2 Depth of Working Space

Working space depths are summarized in Table 3.2. Distances are horizontal (regardless of elevation) and are given from the nearest edge of the equipment because the CSB and WMB have exposed live parts on all sides. Transformers have exposed live parts at their ends where primary and secondary connections are made.

If there are elevation changes within the vault that require stairs or landings, additional working space will be required.

**Table 3.2. Working Space Depth (ft)**

	See Figure	CSB	WMB	Opposite Wall	Column	HVAC Grille	Door	BTS	IWCB	Cables in Conduit	XFMR
<b>CSB</b>	3.3b	6	6	6	6	3	1.5	6	6	6	6
<b>IWCB</b>	3.5b	6	6	6	6	6	6	6	N/A	6	6
<b>XFMR</b>	3.6b, 3.7b	6	6	4	4	4	4	6	6	4	3

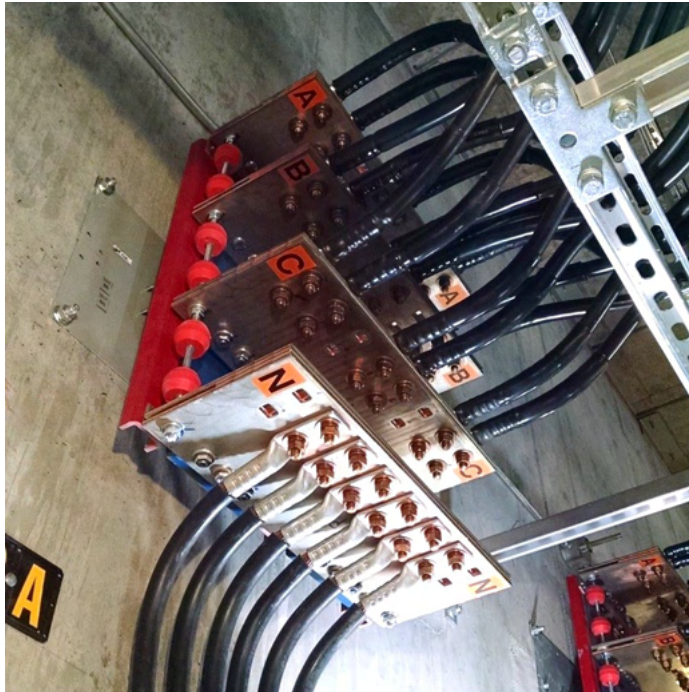
**3.3 Customer Service Bus (CSB) Working Space**

The CSB connects SCL’s in-building vault bus to the customer’s main switchboard for service. See Figure 3.3a.

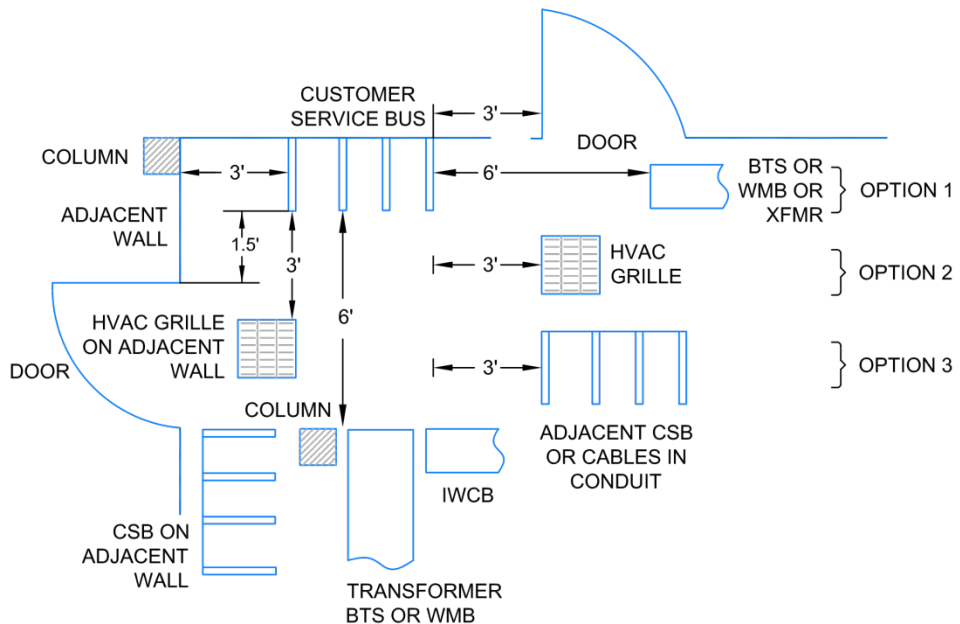
The CSB connects to the Integral Web Channel (or Collector) Bus (IWCB) using heavy cables overhead and requires a lift to train and connect the cables.

The CSB requires side access to make connections, so working space is required in Table 3.1 to enable a worker to stand next to the CSB. See Figures 3.3b and 3.3c.

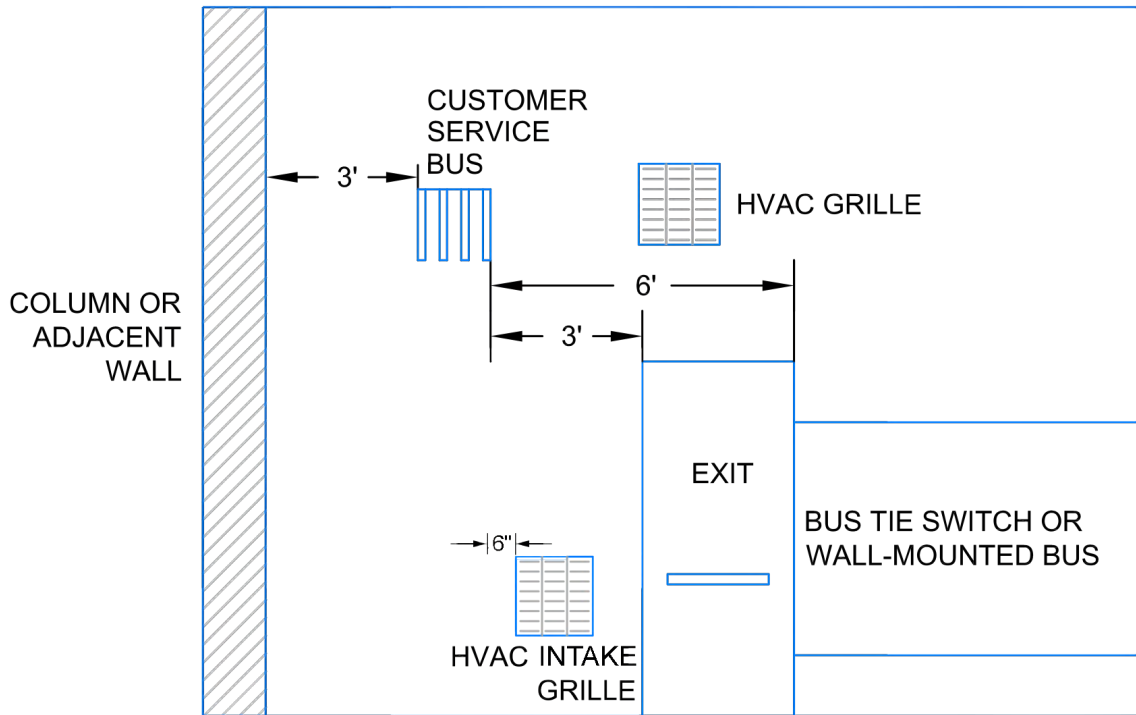
**Figure 3.3a. CSB**



**Figure 3.3b. CSB Working Space, Plan View**



**Figure 3.3c. CSB Working Space, Elevation**



Note: HVAC grille clearance can be reduced for intake grilles per the figure above. See additional requirements in SCL 0751.00.

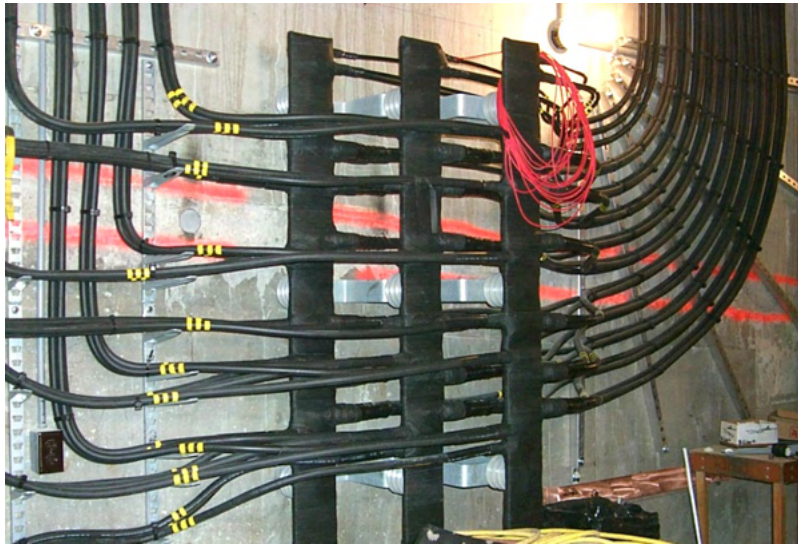
**3.4 Wall Mounted Bus (WMB) Working Space**

When only a small service is required, a WMB might be installed instead of an IWCB. The WMB connects SCL’s in-building vault transformers to the customer service bus using cables. See Figure 3.4a.

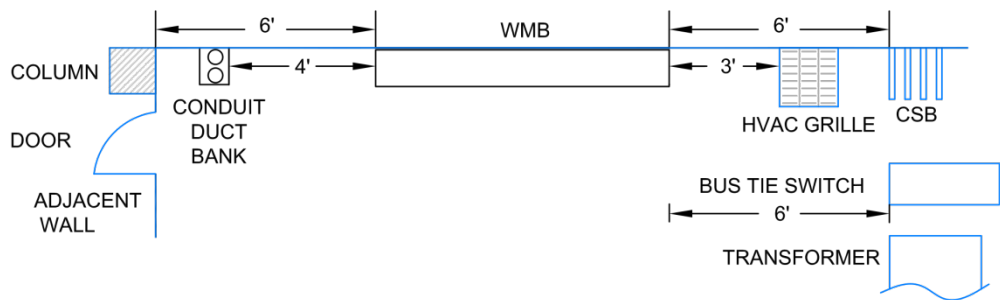
The WMB connects to the transformers and CSB using heavy cables overhead and requires a lift to train and connect the cables.

The WMB requires side access to make connections. Therefore, working space as defined in Table 3.1 is required to enable a worker to stand next to the WMB. See Figure 3.4b.

**Figure 3.4a. WMB**



**Figure 3.4b. WMB Working Space, Plan View**





### 3.5 Integral Web Channel Bus (IWCB) Working Space

The IWCB connects SCL's in-building vault transformers to the customer service bus using cables. See Figure 3.5a.

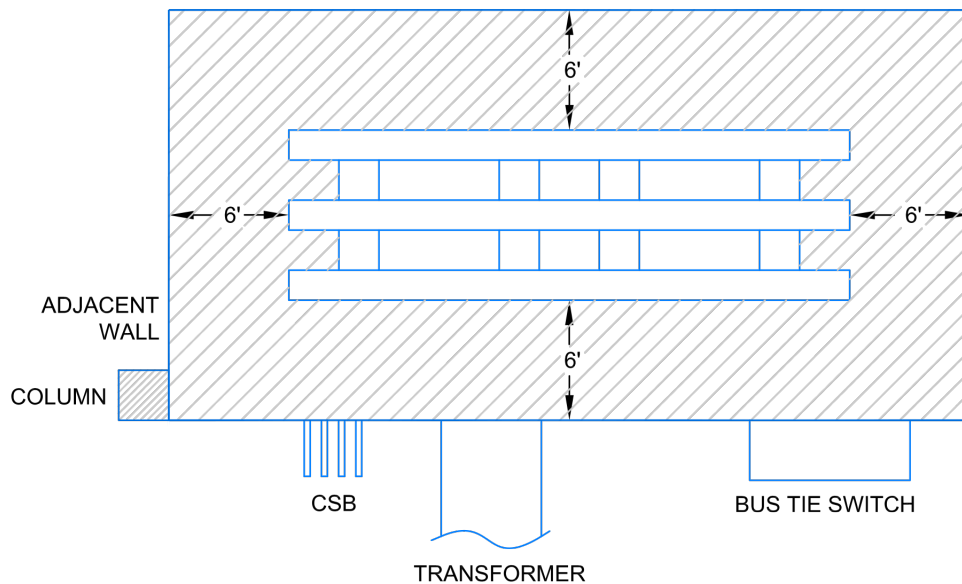
The IWCB connects to the transformers and CSB using heavy cables overhead and requires a lift to train and connect the cables.

The IWCB requires side access in each direction to make connections. Therefore, working space as defined in Table 3.1 is required to enable a worker to stand next to the IWCB. See Figure 3.5b.

**Figure 3.5a. IWCB**



**Figure 3.5b. IWCB Working Space, Plan View**



### 3.6 Network Transformer Working Space

The Network transformer connects SCL's in-building vault primary service to the customer 480 V or 208 V service bus using cables, WMB, or IWCB. See Figure 3.6a.

The transformer connects to the primary service and IWCB using heavy cables overhead and requires a lift to train and connect the cables. The primary side of the transformer contains a switch to disconnect the unit when it is de-energized. Therefore, workers need space in front of the switch to operate it.

The secondary side of a Network transformer has a Network Protector (NP) mounted to it. The NP is a three-phase breaker intended to disconnect power when a fault is detected. The NP has a door that swings out 90 degrees and components that rack out for periodic maintenance. Therefore, working space is required in front of it. See Table 3.2.

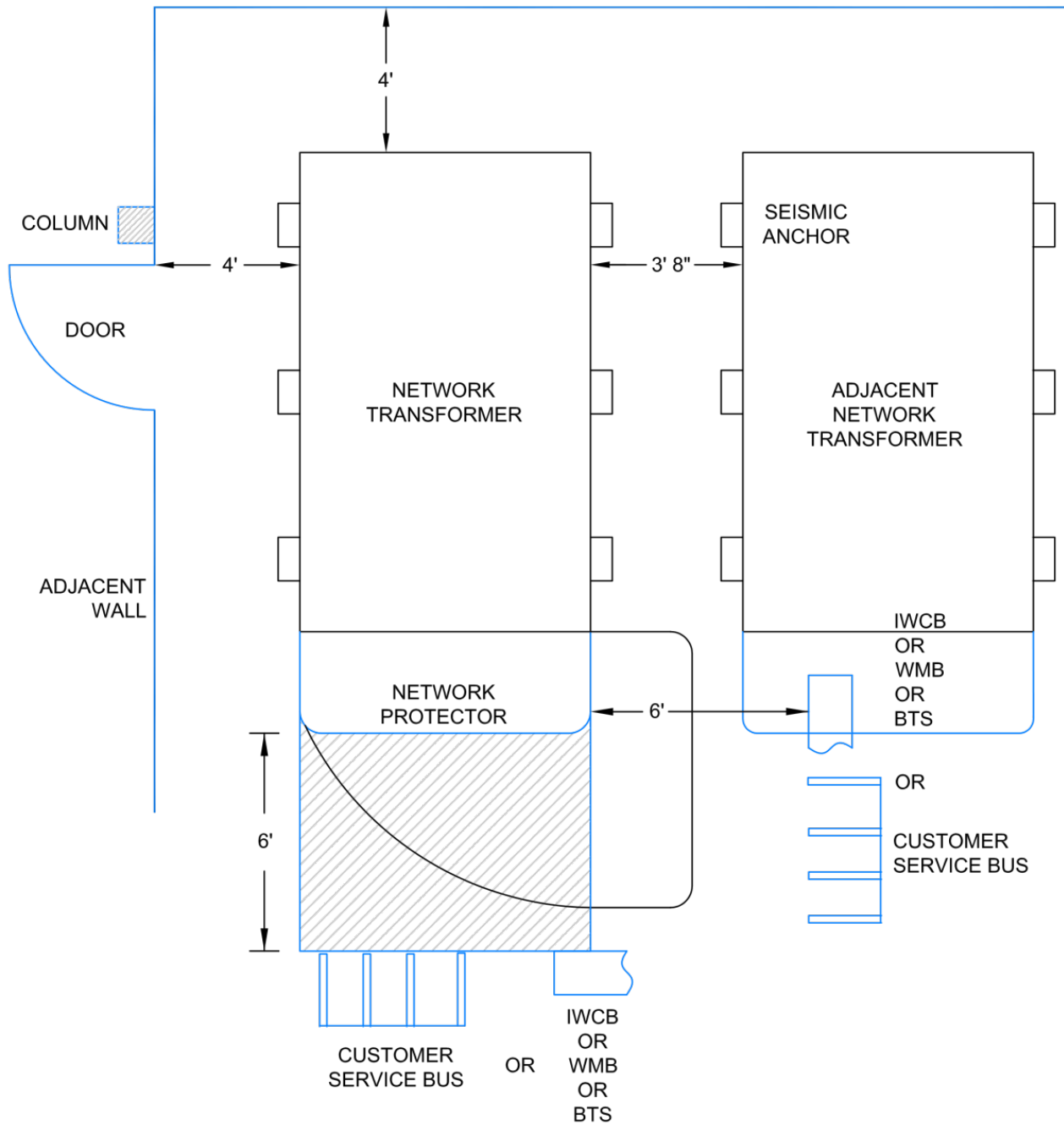
Each transformer is mounted to seismic rails which are anchored or welded to the floor in the vault to prevent movement or damage during a seismic event. These rails extend 4 inches past the case or radiator fins of the transformer. Three feet of clearance between transformers is required from anchor to anchor so that a lift can be moved between transformers. See Figure 3.6b.

**Figure 3.6a. Network Transformer**





**Figure 3.6b. Network Transformer Working Space, Plan View**



### 3.7 Looped Radial Transformer Working Space

Transformers connect the SCL in-building vault primary service to the customer 480 V or 208 V service bus using cables. See Figure 3.7a.

The transformer connects to the primary service and customer gear using heavy cables overhead and requires a lift to train and connect the cables.

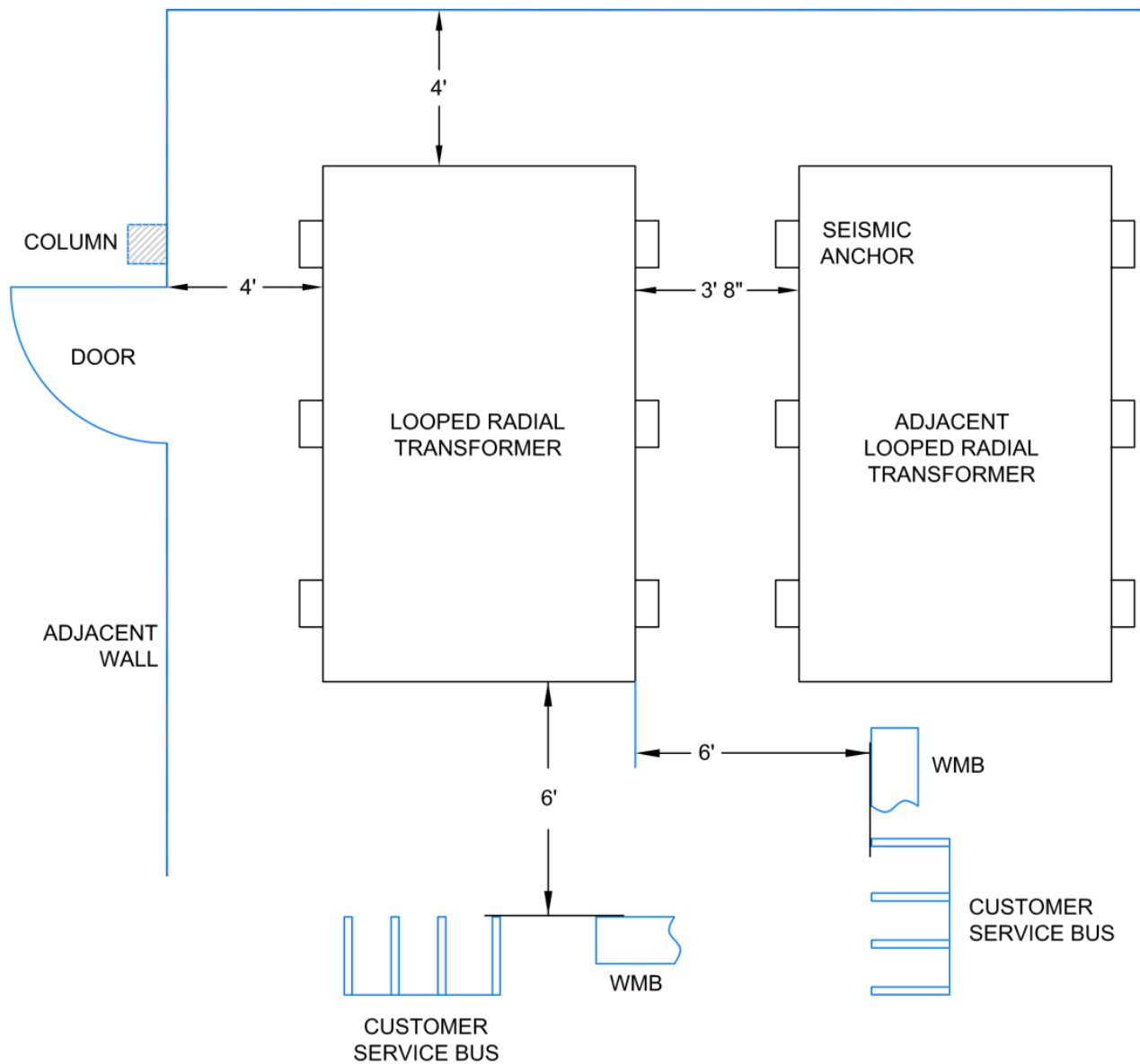
Each three-phase transformer is mounted to seismic rails, which are anchored or welded to the floor in the vault to prevent movement or damage during a seismic event. These rails extend 4 inches past the case or radiator fins of the transformer. Three feet of clearance between transformers is required from anchor to anchor so that a lift can be moved between transformers. See Figure 3.7b.

For single-phase (cylindrical type) transformer installations, see figures 3.7c and 3.7d.

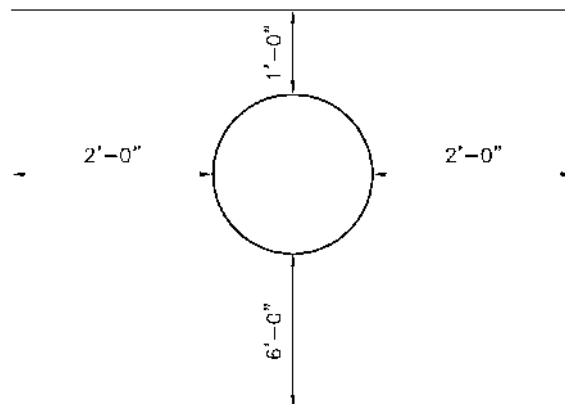
**Figure 3.7a. Looped Radial Three-Phase Transformer**



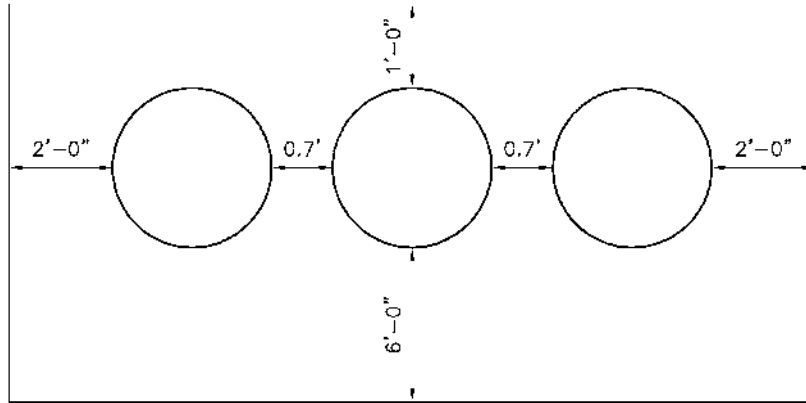
**Figure 3.7b. Looped Radial Three-Phase Transformer Working Space, Plan View**



**Figure 3.7c. Looped Radial Single-Phase Transformer Working Space, Plan View**



**Figure 3.7d. Looped Radial Multiple Single-Phase Transformer Working Space, Plan View**



#### 4. References

**SCL Construction Standard 0751.00**; "Customer Requirements, In-Building Transformer Vaults, Network and Looped Radial Systems"

#### 5. Sources

**Arya, Shayan**; SCL Network Engineer and subject matter expert for 0751.77

**Edwards, Tommy**; SCL Inspector, originator and subject matter expert for 0751.77

**Hanson, Brett**; SCL Standards Engineer, subject matter expert for 0751.77

**Kuhnly, Steve**; SCL Network Crew Chief and subject matter expert for 0751.77

**Legall, Gerard**; SCL Electrical Service Engineer and subject matter expert for 0751.77

---

## Meter Base and Socket Configurations

---

### 1. Scope

This standard covers the requirements for all meter base and socket configurations that are approved for installation in the Seattle City Light (SCL) electric distribution system.

---

### 2. Application

This standard is for customers and contractors who are adding new electric service.

---

### 3. Definitions

**ANSI/NEMA:** American National Standards Institute/National Electrical Manufacturers Association.

**EUSERC:** Electric Utility Service Equipment Requirements Committee.

**Instrument-Rated Services:** Services at or above 400 A that require the use of Current Transformers (CTs) and/or Potential Transformers (PTs).

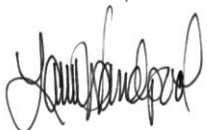
**Block Bypass Socket:** A type of continuous-duty meter socket that allows SCL meter electricians to shunt the current, so that a meter can be removed or installed without drawing an electric arc. See figures 3a and 3c.

**Safety Socket:** A type of meter socket that allows SCL meter electricians to shunt the current and remove the voltage from the meter jaws. See Figure 3b.

**Test Switch:** A device on the meter base for Instrument-rated services that allows for SCL meter electricians to work on the meter socket without service disruption. Test switches are provided and installed by SCL meter electricians. See Figure 3d.

---

Standards Coordinator  
Laura Vanderpool



Standards Supervisor  
John Shipek



Unit Director  
Andrew Strong

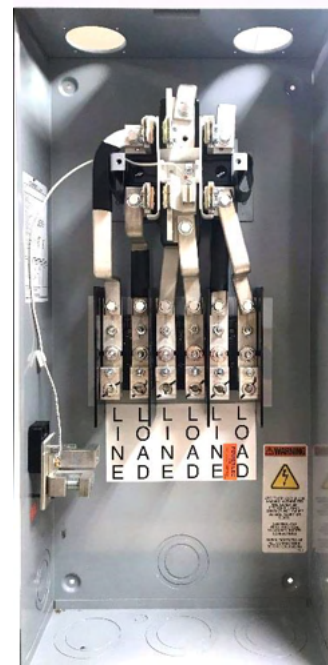


The figures below provide examples of sockets and test switch provisions.

**Figure 3a. Block Bypass Socket, 7-Jaw**



**Figure 3b. Safety Socket, 7-Jaw**



**Figure 3c. Class 320 Block Bypass Socket**



**Figure 3d. Meter Base with Test Switch Provisions**



**Note:** Socket pictured is for example only.  
Socket configuration is defined by service type.

#### 4. Requirements, General

All meter base and socket installations shall be EUSERC compliant and meet the applicable requirements of ANSI/NEMA standards C12.1, C12.16, and C12.20 and the UL 414 standard for meter sockets.

SCL does not allow automatic, lever type, or slide-link socket bypass devices.

All 120/208 V single-phase services shall have the fifth jaw (terminal) at the 9 o'clock position and wired to the neutral in the meter socket.

Block bypass sockets are required for commercial use and recommended for all residential use.

Conductors shall not impede access to block bypass or safety sockets. See Figure 4.

#### **Figure 4. Proper Wire Configuration for Safety and Block Bypass Sockets**



All 480 V services 225 A or less require a safety socket.

SCL does not allow ringless meter sockets or bases of any type.

The only metering taps allowed in meter sockets are: (1) the 5th and 7th terminal connections to the neutral, and (2) a 5th terminal connection to the unmetered leg, as in existing three phase, three-wire Delta services. See Section 6.

All services designated "Live Work" shall be metered to commercial standards.

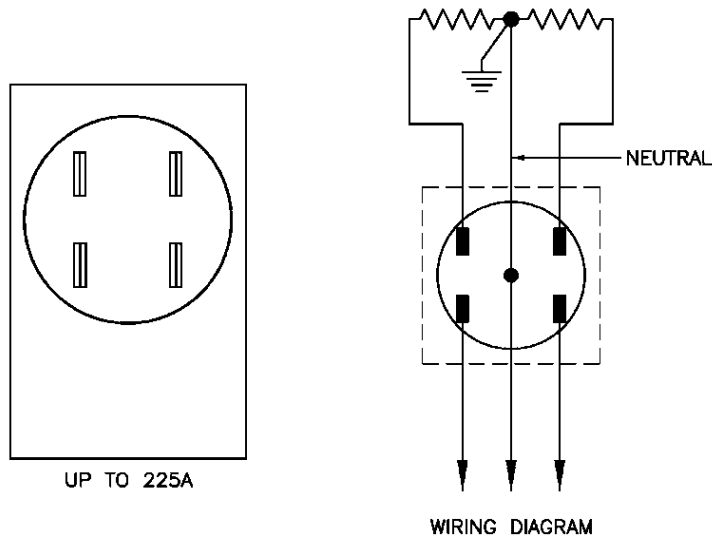
For instrument-rated wiring requirements, refer to the City Light Requirements for Electric Service Connection (RESC).

**5. Residential Meter Configurations**

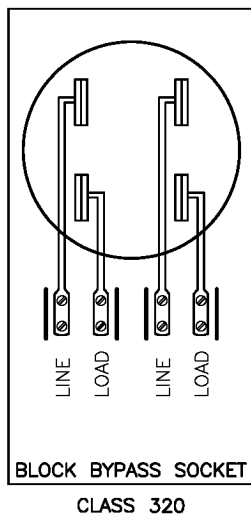
**5.1 Residential Meter Configurations, Metering Capacity Up to 400 A**

Figures 5.1a–c show the residential meter configurations for a metering capacity of up to 400 A.

**Figure 5.1a. Single-Phase, 3-Wire, 120/240 V, Up to 225 A**

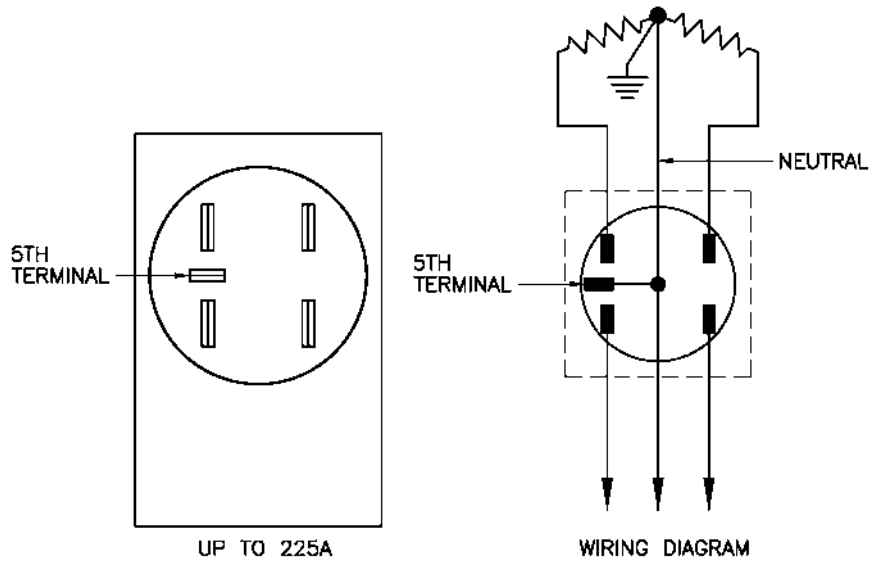


**Figure 5.1b. Single-Phase, 3-Wire, 120/240 V, Up to 400A, Class 320**





**Figure 5.1c. Single-Phase, 3-Wire, 120/208 V, Up to 225 A**

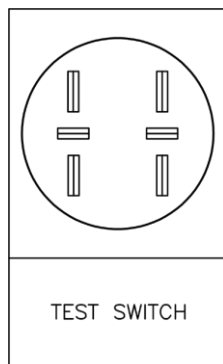


Note: 5th Terminal shall be at the 9 o'clock position.

**5.2 Residential Meter Configurations, Metering Capacity 400 A and Greater**

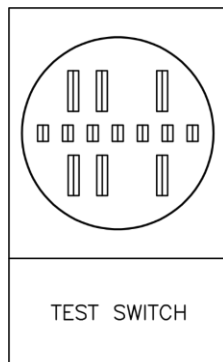
Figures 5.2a and 5.2b show the residential meter configurations for a metering capacity of 400 A and greater.

**Figure 5.2a. Single-Phase, 3-Wire, 120/240 V**



**Note:** Test switch provided by SCL.

**Figure 5.2b. Three-Phase, 4-Wire, 208/120 V**



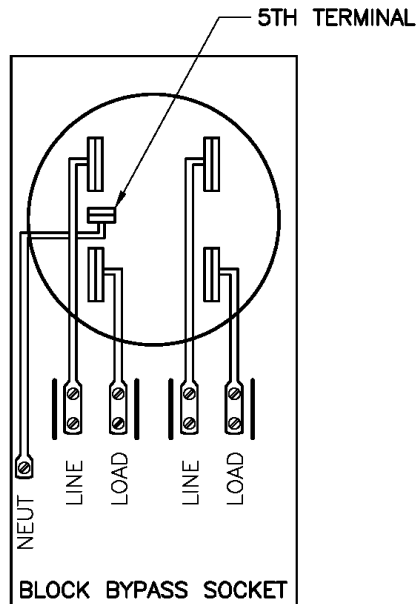
**Note:** Test switch provided by SCL.

**6. Commercial Meter Bases**

All commercial services 225 A or less and under 300 V shall have a block bypass socket. Services greater than 300 V shall have a safety socket.

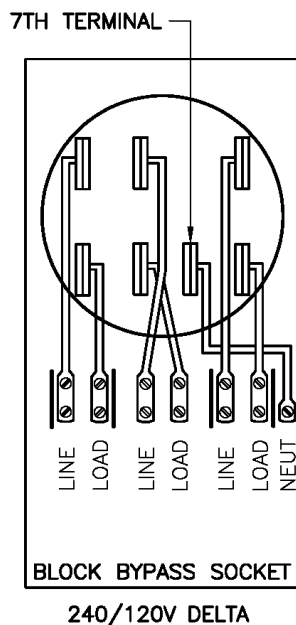
All commercial 120/208 V, single-phase services up to 225 A shall have the 5th terminal at the 9 o'clock position and wired to the neutral in the meter socket. See Figure 6a.

**Figure 6a. Commercial 120/208 V, Single-Phase Services up to 225 A**



All Delta services (240/120 V, three-phase, 4-wire) up to 225 A shall have the high leg on the right-hand jaws (or C phase) of the 7-terminal meter socket. See Figure 6b.

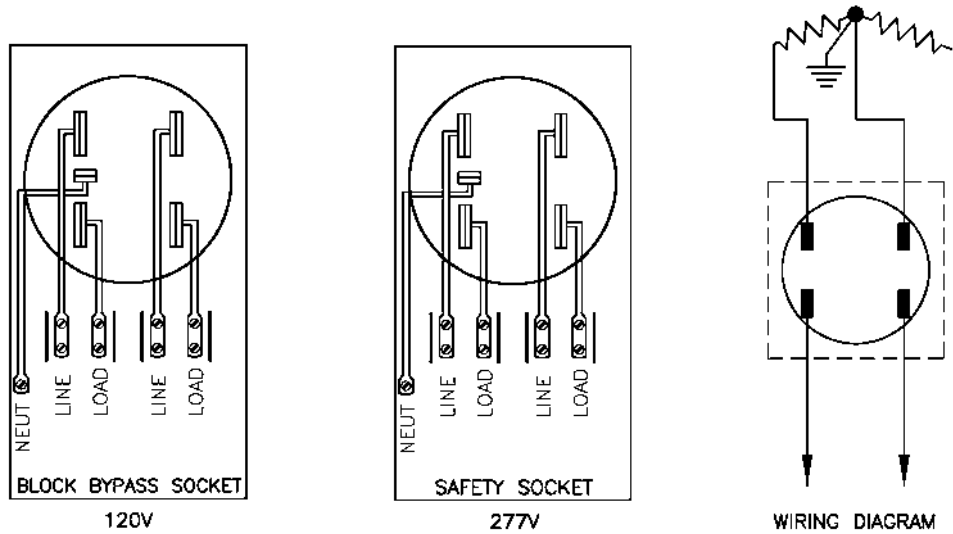
**Figure 6b. Delta Services Up to 225 A**



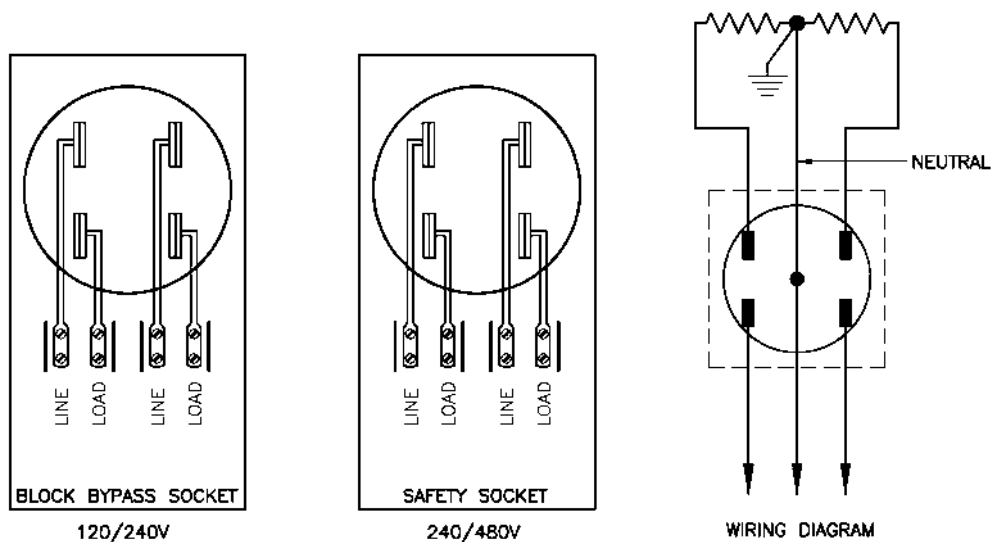
**6.1 Commercial Metering Bases with a Metering Capacity Up to 225 A**

Figures 6.1a–6.1d show all commercial meter base configurations with a maximum metering capacity of 225 A.

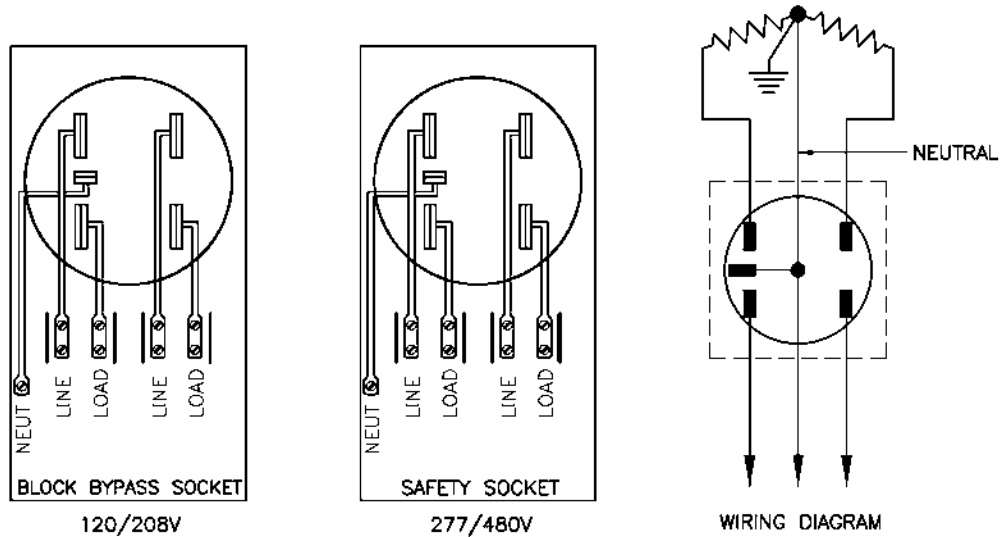
**Figure 6.1a. Single-Phase, 2-Wire, 120 V and 277 V**



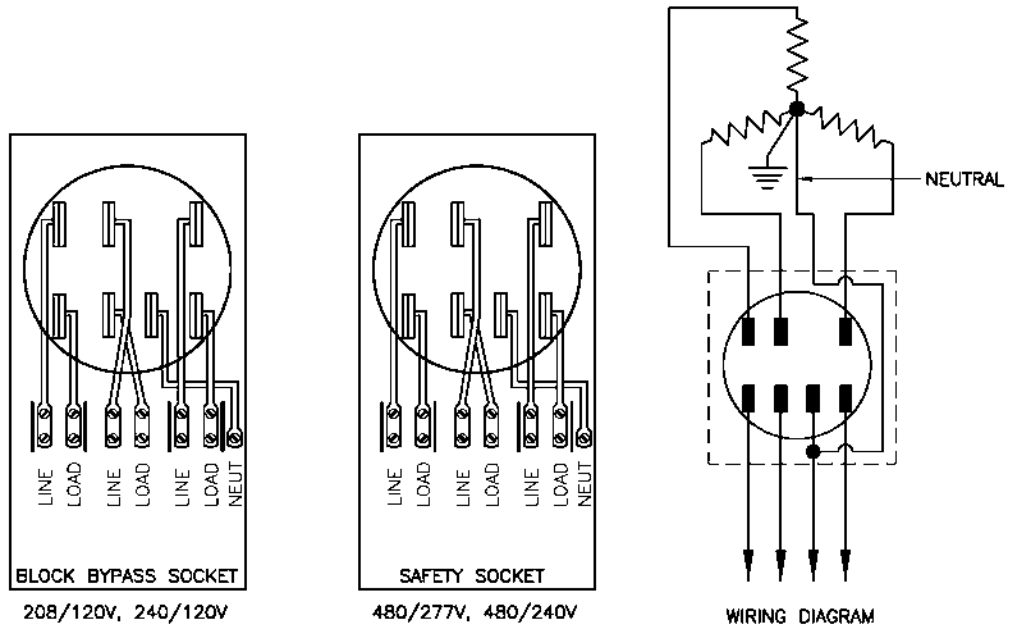
**Figure 6.1b Single-Phase, 3-Wire, 120/240 V and 240/480 V**



**Figure 6.1c Single-Phase, 3-Wire, 120/208 V and 277/480 V**



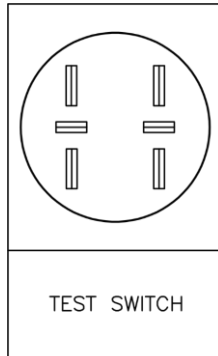
**Figure 6.1d Three-Phase, 4-Wire:**  
**208Y/120 V**  
**480Y/277 V**  
**480/240 V Delta**  
**240/120 V Delta**



## 6.2 Commercial Meter Bases with a Metering Capacity of Greater Than 225 A

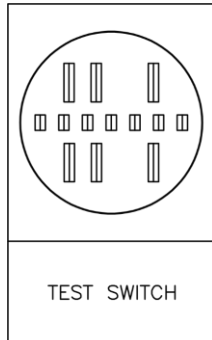
Figures 6.2a and 6.2b show the commercial meter base configurations with a metering capacity of greater than 225 A.

**Figure 6.2a Single-Phase, 3-Wire, 120/240 V and 240/480 V**



**Note:** Test switch provided by SCL.

**Figure 6.2b Three-Phase, 4-Wire**  
**208Y/120 V**  
**480Y/277 V**  
**480/240 V Delta**  
**240/120 V Delta**



**Note:** Test switch provided by SCL.

## 7. References

**ANSI/NEMA C12.1;** “Code for Electricity Metering”

**ANSI/NEMA C12.16;** “Solid-State Electricity Meters”

**ANSI/NEMA C12.20;** “Electricity Meters – 0.1, 0.2, and 0.5 Accuracy Classes”

**Underwriters Laboratories (UL) 414,** “Standard for Meter Sockets”

## 8. Sources

**Electric Utility Service Equipment Requirements Committee (EUSERC) Manual**

**Ellermeier, Todd;** Technical Metering Crew Chief and subject matter expert for 1553.03 (todd.ellermeier@seattle.gov)

**Kimball, Aimee;** Technical Metering Electrical Power Systems Engineer (EPSE), subject matter expert for 1553.03 (aimee.kimball@seattle.gov)

**Langdon, Dan**; Supervisor, Customer Engineering, co-ordinator and subject matter expert for 1553.03 (dan.langdon@seattle.gov)

**SCL Construction DU13-4/NMT-30**; "Meter Base Arrangements" (canceled)

**SCL Construction Standard U12-5/NMT-20**; "Meter Socket Connections and Conductor Identification, 200 Ampere Maximum" (canceled)

**Vanderpool, Laura**; Standards Technical Writer and co-ordinator of 1553.03 (laura.vanderpool@seattle.gov)

---

**Customer Requirements for Underground Residential Service Entrances,  
Single or Dual Meters**



---

**1. Scope**

This standard covers Seattle City Light (SCL) requirements for the permanent installation of underground residential service entrances to a single or dual meter, for 200 A and 320 A, on private property.

The service entrance includes risers, the meter socket, and the meter enclosure.

Refer to the SCL "Requirements for Electrical Service Connection" (RESC) for general information and request for underground secondary service.

Refer to SCL 0224.01 for additional information related to customer requirements for underground secondary service.

Service termination facilities for three or more meters are outside the scope of this standard. See SCL 1561.07.

---

**2. Application**

This standard is for use by SCL customers, engineers, electric service representatives, and operations personnel.

### 3. Conflict

Where conflict exists between requirements, the following order of precedence shall apply:

1. Project-specific Customer Requirements Package, including the service construction drawing
2. SCL 1561.05 (this standard)
3. SCL Requirements for Electric Service Connection (RESC)
4. National Electrical Code (NEC)
5. Other SCL standards

---

### 4. Requirements

#### 4.1 General

The legal service termination point shall be at the meter enclosure.

SCL shall determine the service point (the point in the right-of-way where the customer service conduit is terminated).

The customer shall provide and install one 3-inch conduit from the meter enclosure to the service point per SCL 0224.01.

The customer shall provide and install all service entrance equipment per this standard, the Customer Requirements Package, and the RESC.

The customer is responsible for ensuring against entry of water into the building, into or through service equipment, or other location where the entry of water could be considered a problem.

Direct buried conductors shall not be allowed.

All service secondary risers entering the meter enclosure shall be rigid galvanized steel (RGS).

All conduit shall be 3 inches in diameter.

All bends shall have a 36-inch radius.

Where the meter location presents a potential for damage, the meter shall be recessed in the wall or protected with bollards to meet the clearance requirement (see Section 4.3).

A pulling handhole shall be required to reduce length of conduit run to 150 feet or less, or to reduce the number of conduit bends to 270° (equivalent to three 90° bends) or fewer.

Mandreling and cleaning of conduit shall be done per SCL U2-11.40/NDK-40. This includes pulling-tape requirements.

Manual bypass meter sockets are encouraged but not required. If a manual bypass is installed, the bypass section shall be accessible to SCL.

Services with provisions for alternate power sources shall be designed to eliminate any possibility of back feed into the distribution power system.

Only 200 A and 320 A four-terminal meter bases shall be allowed.

Meters shall be installed only in sockets which are level, plumb, and secured to a structural wall or pedestal.



Meters mounted on concrete or masonry walls shall be fastened by stainless or galvanized metal machine screws in lead sleeves, wedge-type expansion anchors, or quick bolts.

The addition of customer owned equipment between the socket and utility-owned electric meter shall not be allowed.

Dual-meter enclosures shall be permanently labeled with the residential unit served.

## 4.2 Mounting Height

Mounting height requirements shall be as shown in Table 4.2.

**Table 4.2. Mounting Height Requirements**

Mounting Type	Height from Finish Grade to Center of Meter (in)	
	Minimum	Maximum
Recessed (wall)	48	72
Surface (wall)	48	72
Pedestal	36	60
Dual meter (wall)	48	72

## 4.3 Clearances

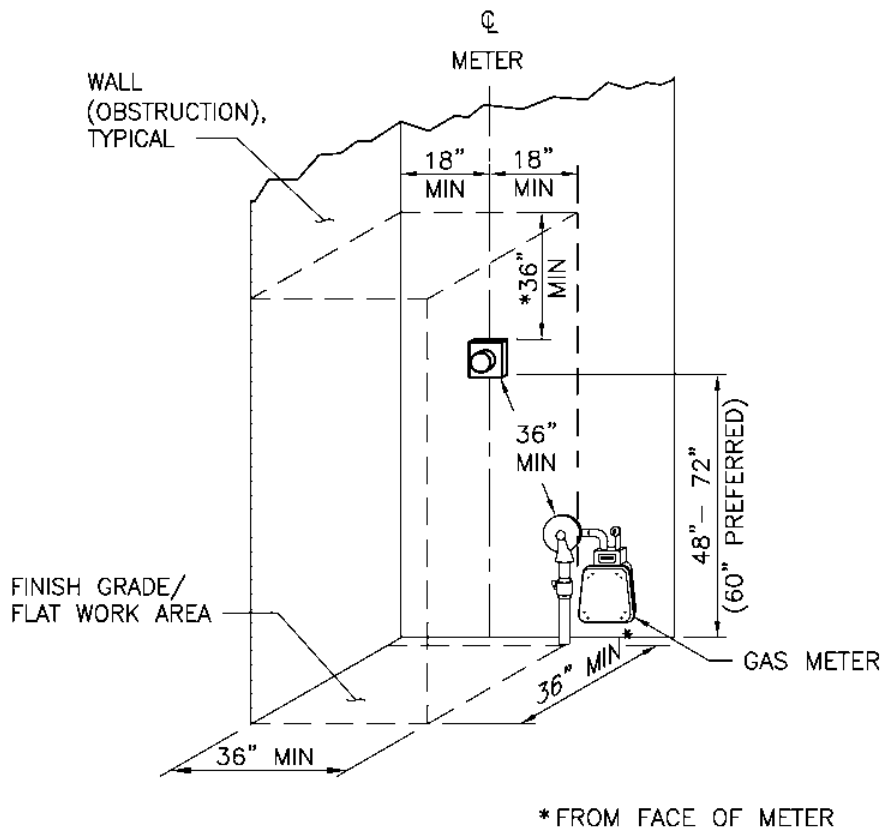
The following minimum clearances shall be maintained:

- Between either side of the electric meter and any walls or protrusions: 18 inches, regardless of elevation
- Above the center of the electric meter: 36 inches
- Between the top of the meter and any operable windows
- Between the closest edge of a gas meter vent and the closest edge of any electric utility enclosure, e.g. meter socket, CT cabinet, tap can, etc.: 36 inches, radial
- Between the closest edge of a hose bib and the closest edge of any electric utility enclosure, e.g. meter socket, CT cabinet, tap can, etc: 18 inches, horizontal

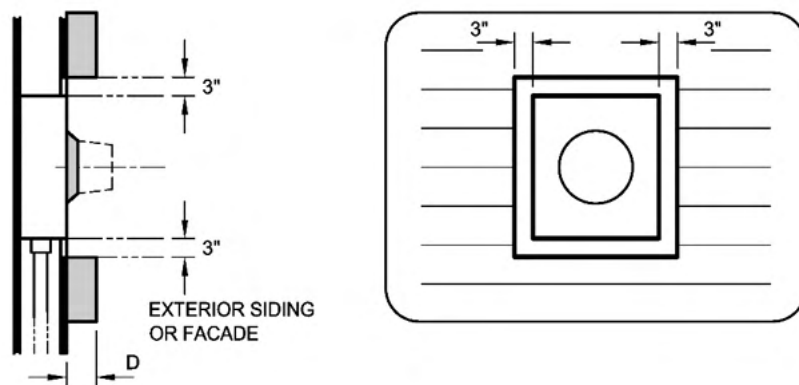
See Figure 4.3a. Meters shall also be installed with no less than 36 inches of flat work area in front of the meter or metering equipment (measured from the front of the meter face).

Recessed-mount meter bases shall be similar to those shown in Figure 4.3a with the additional clearances shown in Figure 4.3b.

**Figure 4.3a. Clearance Requirements**



**Figure 4.3b. Recessed-Mount Meter Additional Clearance Requirements**



**Notes:**

1. The depth (D) of the exterior siding or façade shall not exceed 9 inches.
2. All recessed openings shall provide a 3-inch minimum gap around the meter enclosure to the outer wall and façade. The sealing ring shall not contact the wall or façade.

#### 4.4 Wall-Mount Meters

Wall-mount meters include both surface-mount and recessed-mount types.

For single, 200 A meters, meter enclosure dimensions shall be, at a minimum, 11 in (W) by 14 in (H) by 4-1/2 in (D).

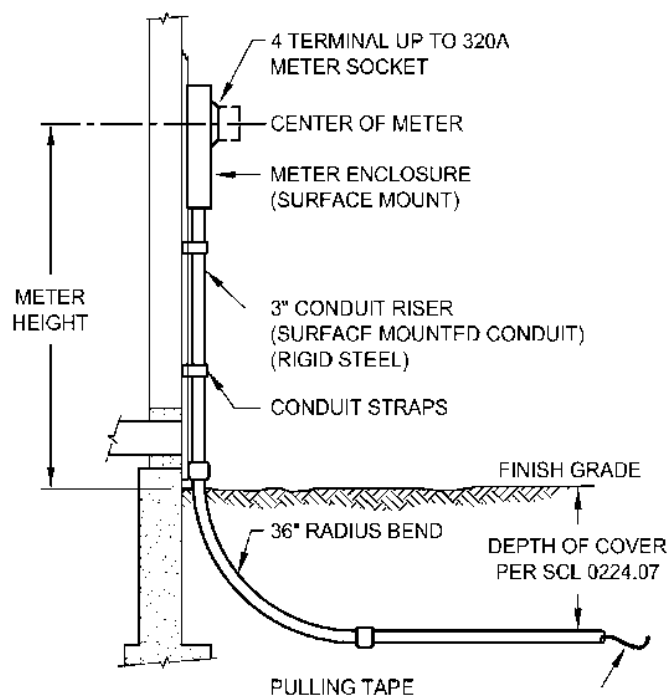
For single 320 A meters, meter enclosure dimensions shall be, at a minimum, 14 in (W) by 32 in (H) by 6 in.

##### 4.4.1. Surface-Mount Meters

A minimum of two conduit straps shall be required to secure riser conduit to the structural wall with 1/4-in lag screws or equivalent.

Surface-mount meter service entrances shall be installed as shown in Figure 4.4.1.

**Figure 4.4.1. Surface-Mount Meter Installation**



**Notes:**

1. For meter heights above finish grade, see Table 4.2.
2. For meter enclosure, conduit, and bend requirements, see Section 4.1.

##### 4.4.2. Recessed-Mount Meters

Recessed-mount meter service entrances shall be installed as shown in Figure 4.4.2.

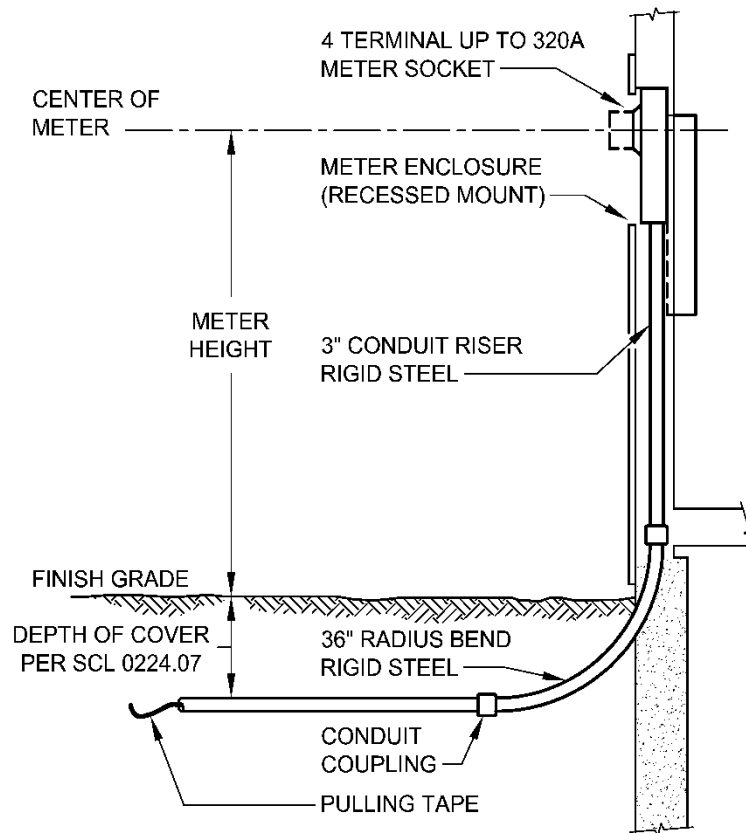
Siding or exterior finish shall not contact the meter enclosure or sealing ring.

The riser shall be 3-in rigid steel.

Recessed-mount meters shall be readily removable.

Recessed-mount meters shall be visible (not hidden, covered, obstructed, camouflaged, or painted).

**Figure 4.4.2. Recessed-Mount Meter Installation**



**Notes:**

1. For mounting heights above finish grade, see Table 4.2.
2. For meter enclosure, conduit, and bends requirements, see Section 4.1.

**4.5 Wiring, Grounding, and Conduit Termination**

For 200 A class sockets, the supply (line side) conduit shall enter through the left or the right knockout at the bottom of the meter enclosure.

The supply (line side) conductors to the meter socket shall be connected to the top terminals. The load conductors shall be connected to the bottom terminals. See Figure 4.5.

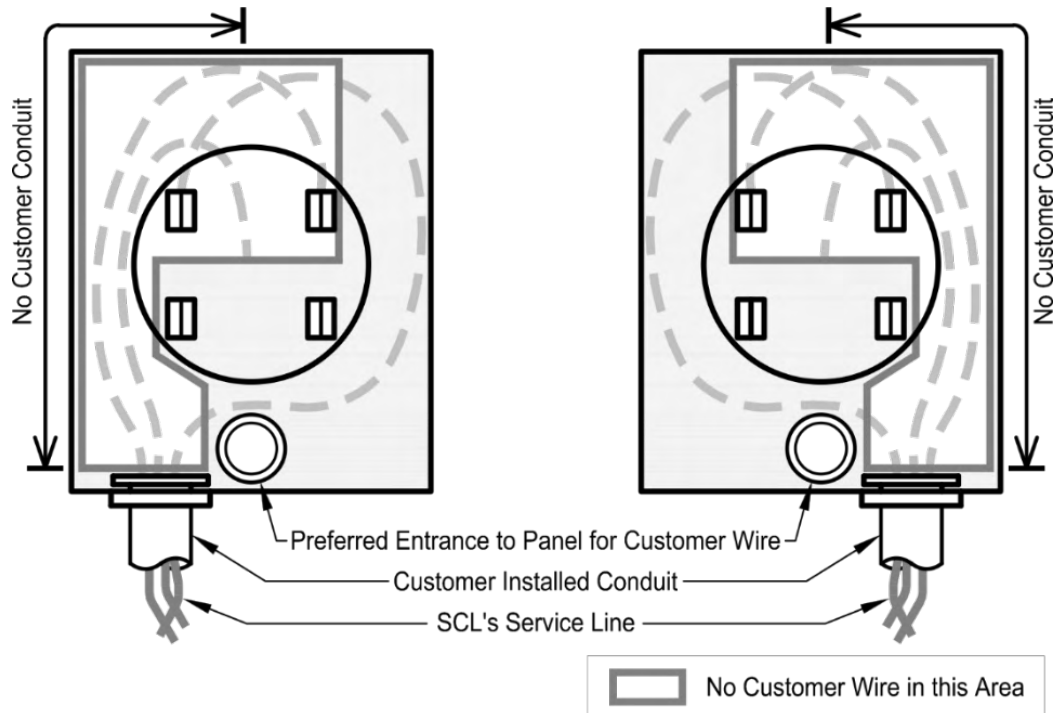
The load side wires shall enter through the side opposite to the supply conductor side and shall not block the path of the supply side conductors.

For 320 A class sockets, the supply conduit shall enter the center knockout at the bottom of the meter enclosure.

The neutral wire shall be grounded in the meter socket.

All meters, sockets, enclosures, and conduit shall be bonded and effectively grounded in accordance with NEC Article 250 and WAC 296-46B-250.

**Figure 4.5. Wiring and Conduit Termination into the Enclosure**



**4.6 Pedestal Mount Meters**

Pedestal mount meters consist of a 200 A configuration and a 320 A configuration.

This mounting option is for metering permanent residential loads where the meter location is NOT at the load location or structure. The conductors that run from the meter to the load location shall be installed, owned, and maintained by the property owner.

See Section 4.3 for clearance requirements.

Conduits straps shall be rigidly fastened to the post support with 1/4-in lag screws or equivalent.

A minimum of 4 inches of concrete shall be poured around the base of the pedestal. The poured concrete shall be crowned and tapered away from the post above finish grade.

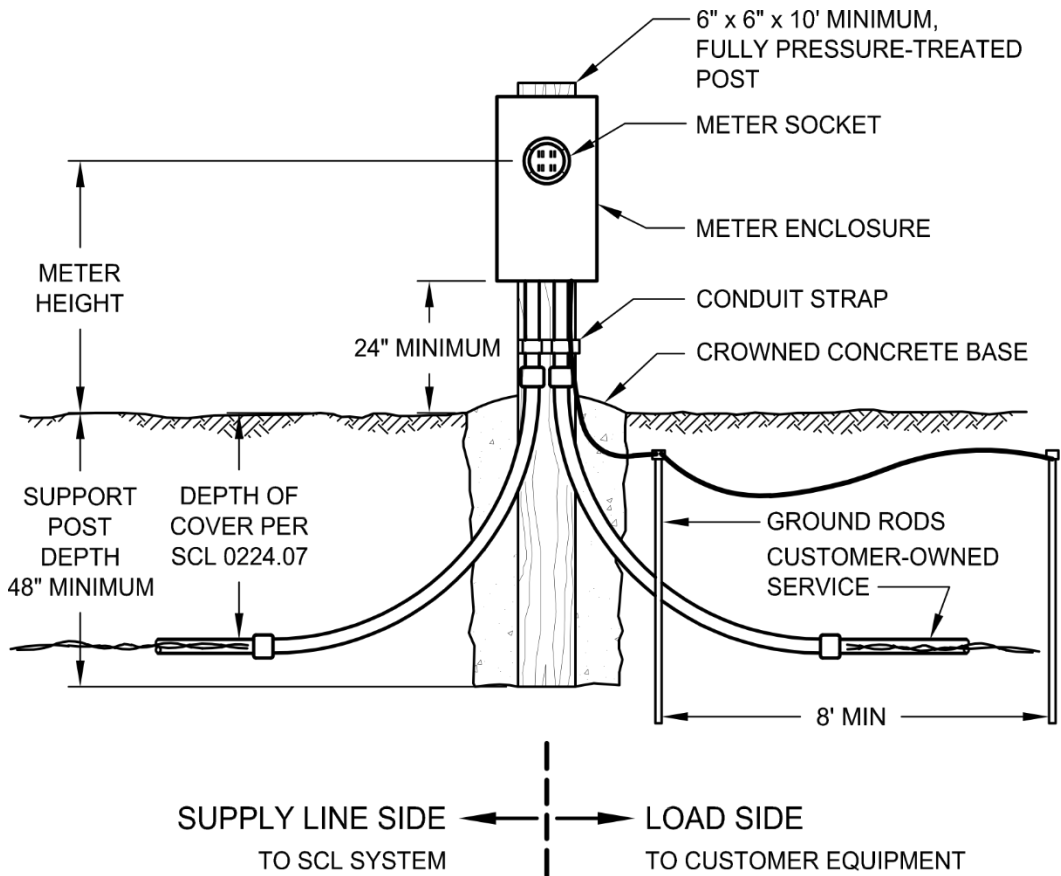
**4.6.1. Pedestal-Mount Meters, 200 A**

Meters shall be installed as shown in Figure 4.6.1.

The meter enclosure dimensions, shall be, at a minimum, 11 in (W) by 14 in (H) by 4-1/2 in (D).

The meter pedestal at a minimum, shall be a 6 in by 6 in by 10 ft fully pressure-treated wood post in a concrete-poured base.

**Figure 4.6.1. Pedestal-Mount Meter, 200 A**



**Notes:**

1. For mounting heights above grade, see Table 4.2.
2. For meter enclosure, conduit, and bends requirements, see Section 4.1.

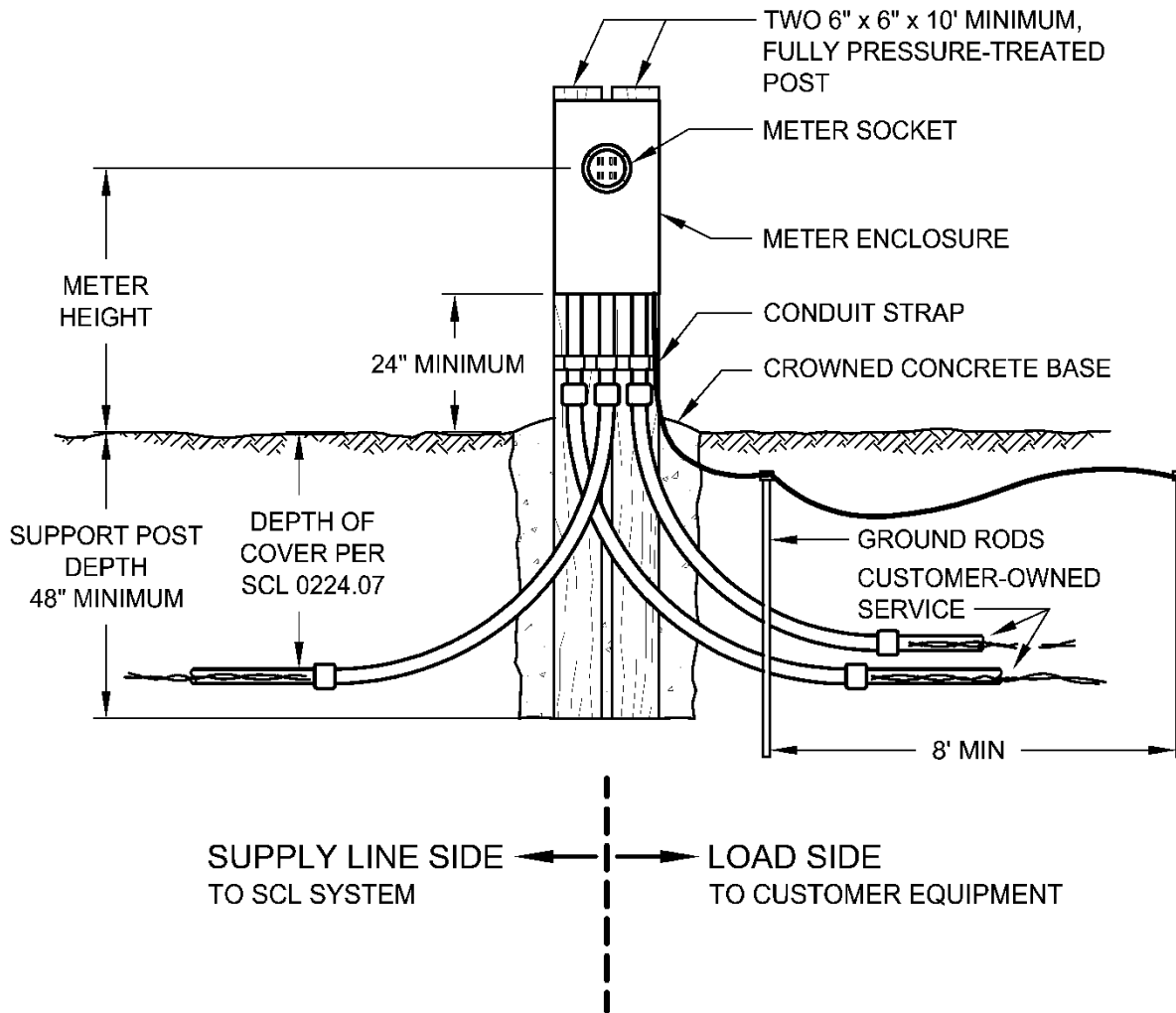
**4.6.2. Pedestal-Mount Meter, 320 A Configuration**

Pedestal-mount meters for a 320 A configuration shall be installed as shown in Figure 4.6.2.

The meter enclosure dimensions shall be, at a minimum, 14 in (W) by 32 in (H) by 6 in (D).

The meter pedestal, at a minimum, shall consist of two 6 in by 6 in by 10 ft fully pressure-treated, ground contact posts in a concrete-poured base.

**Figure 4.6.2. Pedestal-Mount Meter, 320 A**



- Notes:**
1. For mounting heights above grade, see Table 4.2.
  2. For meter enclosure, conduit, and bends requirements, see Section 4.1.

## 5. References

**NFPA 70**; National Electric Code (NEC); 2011 Edition, National Fire Protection Association, Quincy, MA, 2008

**Requirements for Electrical Service Connection (RESC)**; Seattle City Light, latest reversion

**SCL Construction Standard 0224.01**; "Customer Requirements for Underground Secondary Service, Looped Radial System"

**SCL Construction Standard 0224.07**; "Requirements for Secondary Conduit Installation"

**SCL Construction Standard 1561.07**; "Customer Requirements for Underground Secondary Service Termination Facilities"

**SCL Construction Standard U2-11.40/NDK-40**; Mandreling and Cleaning of Ducts"

**WAC 296-46B-250**; "Wiring and Protection—Grounding and Bonding", Washington Administrative Code

---

## 6. Sources

**Edwards, Tommy**; SCL Electrical Reviewer and subject matter expert for SCL 1561.05

**Electric Utility Service Equipment Requirement Committee (EUSERC)**; "EUSERC Drawing 300", [www.euserc.com](http://www.euserc.com)

**National Electrical Safety Code (NESC) C2-2017 Edition**; Institute of Electrical and Electronics Engineers (IEEE), 2016

**National Electrical Manufacturers Association (NEMA) TC 2-2013**; Electrical Polyvinyl Chloride (PVC) Conduit

**Neuansourinh, Ponet**; SCL Standards Engineer and originator of SCL 1561.05;

**Perander, Eivind**; SCL North Distribution Supervisor and subject matter expert for 1561.05

**SCL Construction Guideline U12-1.3/NMT-10** (canceled); "Meter Location and Conduit Entrance Details for Secondary Underground Residential Service, Class 320 Maximum"

**SCL Construction Standard 1553.03**; "Meter Base and Socket Configurations"

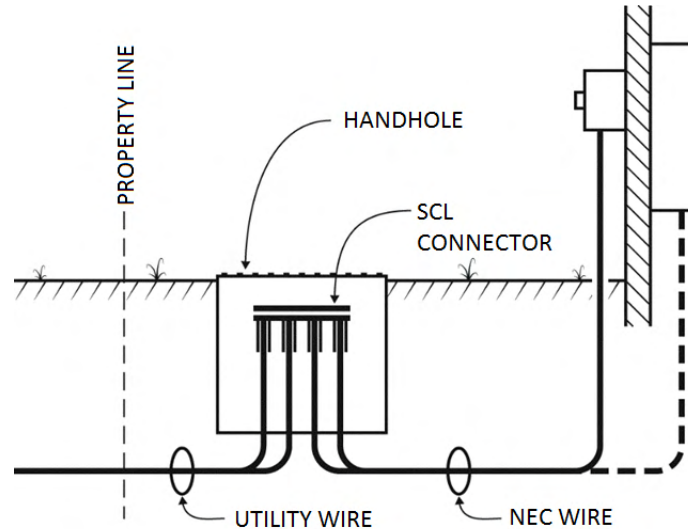
**SCL Work Practice 0035.13**; "Voltage Zones"

**UL414**; "Underwriters Laboratories Standard for Meter Sockets"

**WAC 296-45-325**; "Working on or Near Exposed Energized Parts"; Washington Administrative Code



## Customer Requirements for Underground Secondary Service Termination Facilities



### 1. Scope

This standard outlines Seattle City Light (SCL) requirements for the permanent installation of underground secondary service termination facilities, including:

- Service enclosures
- Current transformers (CT) enclosures
- Handholes

Underground secondary service termination points are only applicable to services located on private property, and where the SCL service point is located in the public right-of-way or SCL easement area.

Single- and dual-meter residential services up to 320 A are outside the scope of this standard. See SCL 1561.05.

Services where the customer provides a facility on private property to house SCL transformers are outside the scope of this standard.

### 2. Application

This standard is intended for use by customers and SCL engineering, electric service representatives (ESRs), and operations personnel.

Standard Coordinator  
Brett Hanson

Standards Engineering Supervisor  
John Shipek

Division Director  
Andrew Strong

### 3. Conflict

Where conflict exists between SCL requirements, the following order of precedence shall apply:

1. Project-specific Customer Requirements Package, including the Service Construction Drawing
2. SCL 1561.07
3. SCL Requirements for Electric Service Connection (RESC)

---

### 4. Requirements

All customer-installed equipment shall meet SCL requirements.

The service termination facility shall be provided and installed by the customer per the Customer Requirements Package and the RESC.

Customer-owned cable shall comply with the National Electrical Code (NEC) and shall be visibly marked at the point of termination (service point) to indicate phase and service being fed.

The service termination facility shall not be placed in depressions or low areas that tend to fill with water or silt. SCL strongly suggests that the service termination facility is located at an elevation above the elevation of the right-of-way in order to avoid water flowing into the building through service conduit(s). It is the customer's responsibility to install conduits and equipment at elevations that prevent water from entering the building.

Conduit entering the building shall be rigid galvanized steel (RGS) conforming to SCL 7050.05 beginning from one foot outside the building. Conduit shall be isolated from building steel.

The conduit riser on the building shall be rigid galvanized steel. The conduit shall be securely fastened to a wall by a minimum of two conduit straps.

All meters, sockets, enclosures, and conduit shall be bonded and effectively grounded in accordance with NEC Article 250 and WAC 296-46B-250.

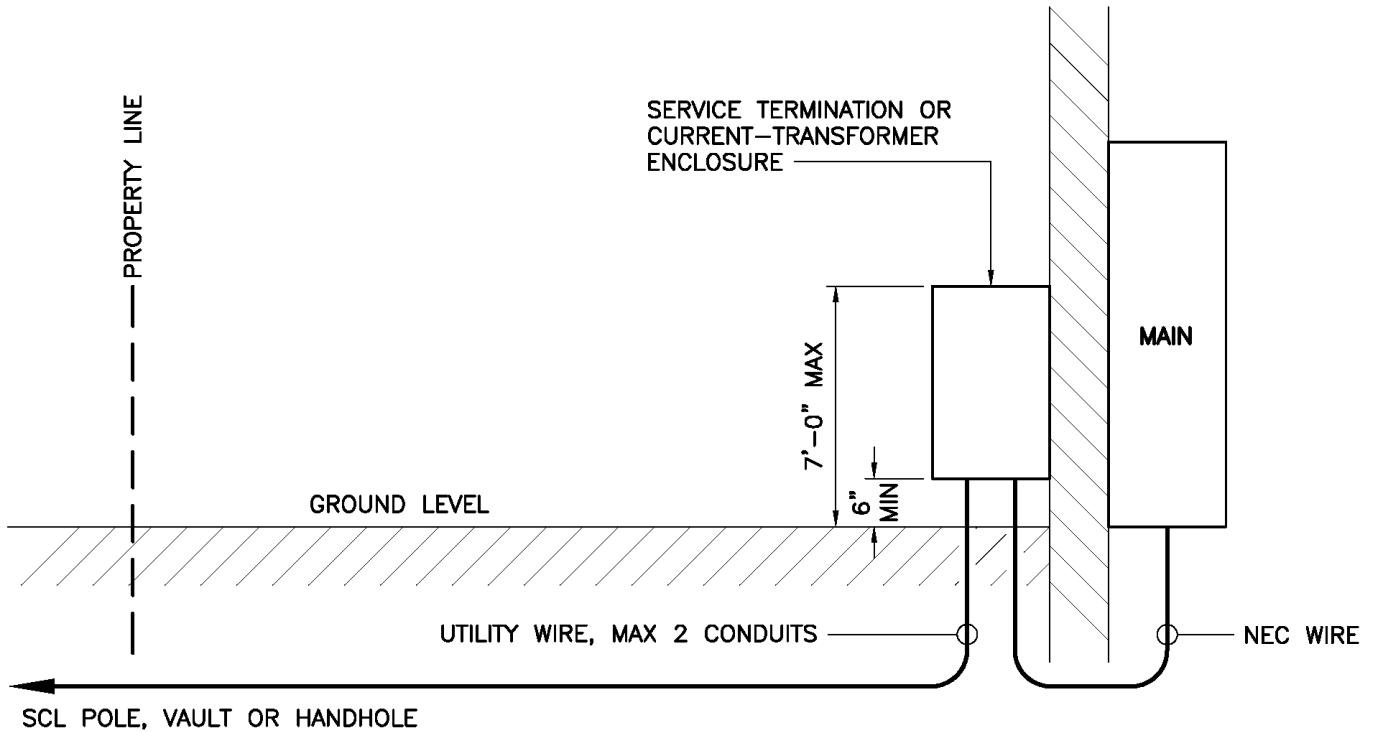
See the RESC for additional metering requirements.

---

### 5. Service Termination Requirements

Wall-mounted service termination facilities shall meet the requirements shown in Figure 5.

**Figure 5. Wall-Mounted Service Entrance Requirements**



**5.1 Multi-Unit Meter Bank**

A multi-unit meter bank is defined as three or more meters. These installations require a combination terminating enclosure and multi-meter panel for residential services per EUSERC 342. A service enclosure or handhole per sections 5.2 and 5.4 may be used with engineering approval prior to application.

**5.2 Service Enclosure**

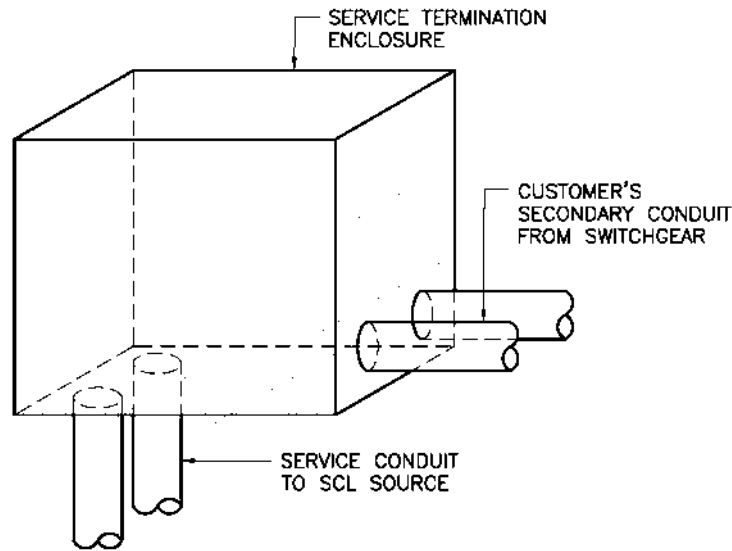
The minimum interior dimensions of a service enclosure are based upon the number of cables entering the enclosure. Table 5.2 shows required dimensions for service enclosures.

The enclosure shall have a hinged cover.

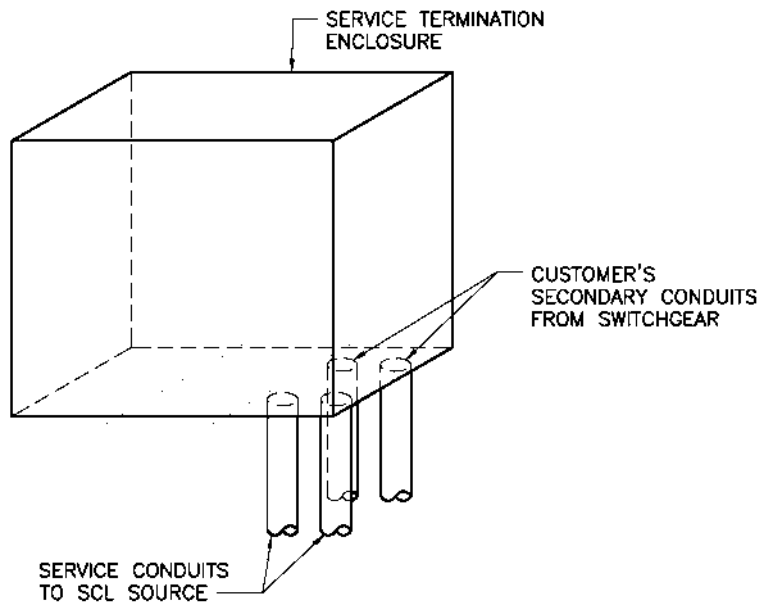
**Table 5.2. Service Enclosure Sizing**

Maximum Amps	Maximum NEC Wires from Customer			Termination Options
	# of Sets	AWG/kcmil	Size (W x H x D) (in)	
400	2	4/0	24 x 32 x 11	A or B
400	2	250	30 x 36 x 11	A or B
600	3	350	36 x 36 x 11	A
600	3	350	40 x 36 x 11	B
600	2	500	36 x 36 x 11	A or B
1000	4	500	48 x 48 x 11	A or B

**Figure 5.2a. Service Enclosure Termination Option A**



**Figure 5.2b. Service Enclosure Termination Option B**



Conduits shall enter near the corners of the service enclosure but not through the back of the enclosure. Conduits shall not enter the same corner of the enclosure from two directions. Conduits shall be terminated no more than one third of the width away from the adjacent wall.

Service enclosures installed inside a building shall be located so the service conduits from the SCL source do not enter the building more than 18 inches.

### 5.3 Current Transformer Enclosure

Install a CT enclosure that meets the requirements found in the RESC.

The minimum interior dimensions are based on the service size. Table 5.3 shows required dimensions for current transformer enclosures.

The enclosure shall have a hinged cover.

**Table 5.3. Current Transformer Enclosure Sizing**

Maximum Service	Size (W x H x D) (in)
Single-phase, 400 A	24 x 48 x 11
Single-phase, 600 A	36 x 48 x 11
Three-phase, 800 A	36 x 48 x 11

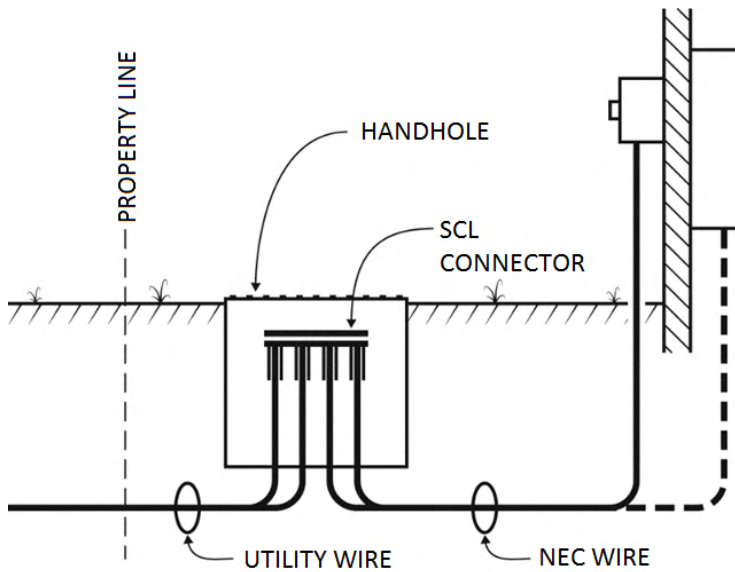
A switchboard termination is required for current transformers rated above 800 amperes.

### 5.4 Handhole

A handhole used as a service termination facility shall be installed at the location shown on the SCL Site Plan of the Customer Requirements Package.

The handhole type shall be provided, installed, and grounded by the customer per SCL 0224.01.

**Figure 5.4. Handhole**



The minimum interior dimensions are based upon the number of cables entering the handhole. Table 5.4 shows required dimensions for service termination handholes.

**Table 5.4. Handhole Sizing**

Maximum Service	Maximum Conduit Size (in)	Maximum NEC Wires from Customer			Size (W x L x D) (in)	Material	Material Std.
		# of Sets	AWG/kcmil				
Single-phase, 600 A	3	3	4/0		17 x 28 x 24	Concrete	7203.10
Single-phase, 600 A	3	3	4/0		17 x 30 x 24	Fiberglass	7203.12
Single-phase, 600 A	3	4	4/0		30 x 30 x 24	Concrete	7203.04
Three-phase, 1000 A	4	4	350		24 x 36 x 36	Concrete	7203.08
Three-phase, 1000 A	3	4	350		24 x 36 x 36	Fiberglass	7203.12
Three-phase, 1000 A	4	4	500		48 x 48 x 48	Concrete	7203.26

Precast concrete handholes are allowed in walkways, sidewalks, and areas subject to minor, incidental vehicular traffic.

Composite fiberglass handholes shall only be located in landscaped areas.

## 6. Conduits

Conduits shall be installed from the service termination point to an SCL distribution facility per SCL 0224.01. See the project-specific requirements package for the location of the distribution facility.

If the SCL distribution facility is located across the street, two conduits shall be required.

Customer shall provide conduits per Table 6.

**Table 6. Conduit Quantity and Size**

Maximum Service	No. of Conduits	Size (in)
Single-phase, 400 A	1	3
Single-phase, 600 A	1	4
Three-phase, 600 A	1	4
Three-phase, 1000 A	2	4

**7. Service Conduits and Cables**

Customers are responsible for providing National Electrical Code (NEC)-sized service conduits and cables from the service termination point to the customer’s switchgear. Table 7 shows allowable conductor sizes.

**Table 7. Allowable Conductors for Electrical Service Connection**

Conductor Size	Copper		Aluminum
	Concentric Round Stranded	Concentric Round Stranded and Compressed Stranded	Compact Stranded
#2 AWG	OK	OK	–
#1 AWG	–	OK	OK
1/0	OK	OK	OK
2/0	OK	OK	OK
3/0	OK	OK	OK
4/0	OK	OK	OK
250 kcmil	OK	OK	OK
300 kcmil	OK	OK	OK
350 kcmil	OK	OK	OK
400 kcmil	–	OK	OK
500 kcmil	OK	OK	OK

The customer shall extend eight feet of excess cable per conductor into the service enclosure or handhole for connection by SCL.

**8. References**

**EUSERC Electric Utility Service Equipment Requirement Committee (EUSERC);** “EUSERC Drawing 342”, [www.euserc.com](http://www.euserc.com)

**NFPA-70;** National Electric Code (NEC); National Fire Protection Association, Quincy, MA, 2017

**Requirements for Electrical Service Connection (RESC);** Seattle City Light

**SCL Construction Standard 0224.01;** “Customer Requirements for Underground Secondary Service, Looped Radial System”

**SCL Construction Standard 1561.05;** “Customer Requirements for Underground Single or Dual Meters, Residential Service”

**SCL Material Standard 7203.04;** “3030 Handhole, Precast, Secondary”

**SCL Material Standard 7203.08;** “231 and 233 Handholes, Precast, Secondary and Streetlight, Detailed”

**SCL Material Standard 7203.10;** “Type 1 and Type 2 Open Bottom Handhole, Precast, Secondary and Streetlight”

**SCL Material Standard 7203.12;** “Handhole, Secondary, Composite Fiberglass, Polymer Concrete”

**SCL Material Standard 7203.26;** “444 Electric Vault, Primary Service”

**Washington Administrative Code (WAC) 296-46B-250**

## 9. Sources

**Chao, Yaochiem**; SCL Standards Engineer, originator, and subject matter expert for 1561.07

**Franklin, Stephanie**; SCL Electrical Service Representative and subject matter expert for 1561.07

**Hanowell, Manny**; SCL North Distribution Engineer and subject matter expert for 1561.07

**Panomvana, Tanya**; SCL North Distribution Engineer and subject matter expert for 1561.07

**Perander, Eivind**; SCL North Distribution Supervisor and subject matter expert for 1561.07



## Customer Requirements for Underground Secondary Service Termination Handholes in the Public Right-of-Way



### 1. Scope

This standard covers the requirements for the construction and installation of underground secondary service terminations in the public right-of-way in the Seattle City Light (SCL) service territory. This standard only applies to underground service installations where the point of termination is in the right-of-way.

For underground secondary services on private property, refer to SCL 0224.01.

### 2. Application

This standard provides direction to engineers, consultants, contractors and customers about how to properly install an underground secondary service in the public right-of-way.

This standard also provides the details to be used for inspection by SCL electric service representatives/engineers, civil inspectors and electrical reviewers.

### 3. General Requirements

Customer shall meet underground secondary service requirements. See SCL 0224.01.

Customer shall meet clearances between SCL underground structures and other utility structures in the public right-of-way. See SCL 0214.00.

Customer shall meet termination handhole installation requirements. See SCL 0231.01.

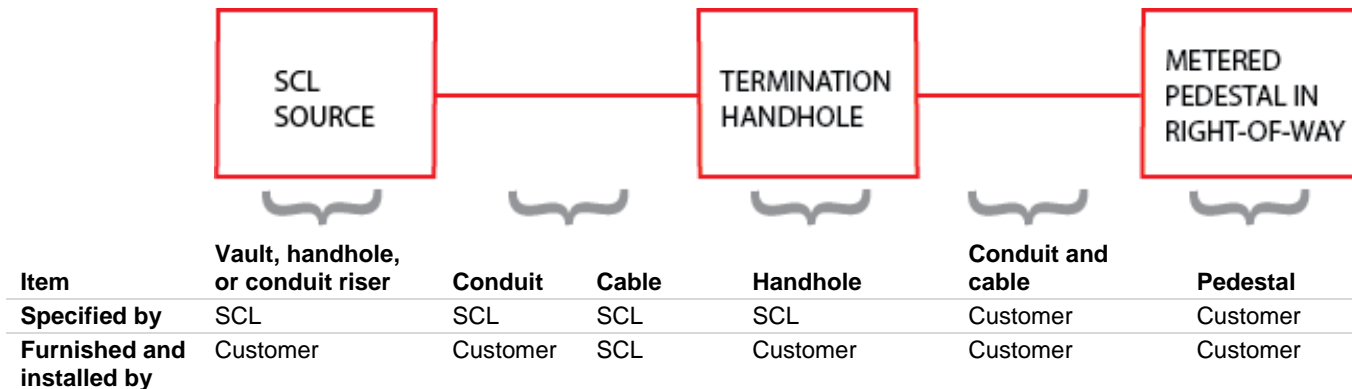
See Figure 3 for SCL and customer responsibilities.

Standards Coordinator  
Brett Hanson

Standards Supervisor  
John Shipek

Unit Director  
Darnell Cola

**Figure 3. Basic Infrastructure of a Customer System in the Right-of-Way**



**4. Detailed SCL Responsibilities**

SCL equipment, including the termination handhole, is covered by the NESC.

SCL shall designate service points for customer electrical services from a distribution source. Streetlight circuits shall not be tapped for customer equipment or loads.

An SCL electrical reviewer shall inspect and test systems before service connections are made.

**5. Detailed Customer Requirements**

Customer shall install a pedestal-mounted, external service disconnect or other approved service disconnect. The pedestal shall be above grade.

The service equipment pedestal or other approved service disconnect shall be located after the termination handhole (service point).

Meter requirements shall be determined by SCL Customer Engineering.

The Authority Having Jurisdiction (AHJ) shall inspect and approve each customer electrical installation before service connections are made by SCL.

All conductive components in termination handholes shall be bonded to the grounding electrode.

Connections to the grounding electrode shall be made by irreversible means. Above grade connections may be irreversibly bolted or exothermically welded. Below grade connections shall be exothermically welded.

Customer shall determine if service overcurrent protection will be either fuses or a circuit breaker. Customer overcurrent devices shall be installed in the customer service equipment pedestal.

Customer shall furnish and install NEC-sized conductors from the termination handhole to the customer service pedestal. SCL shall install conductors from the SCL source to the termination handhole and make all connections in the termination handhole and at the SCL source.

Customer equipment from the customer conductors in the termination handhole and downstream is covered by Seattle Electrical Code Article 80 and the NEC.

Customer service bond shall be located at the customer service metered pedestal or other approved disconnect.

## 6. References

**SCL Construction Standard 0214.00**; “Clearances between SCL Underground Structures and Other Utility Structures in the Public Right-of-Way”

**SCL Construction Standard 0224.01**; “Customer Requirements for Underground Secondary Service, Looped Radial System”

**SCL Construction Standard 0231.01**; “Secondary Handhole Installation”

---

## 7. Sources

**Hanson, Brett**; SCL Standards Engineer and originator of 1561.09  
(brett.hanson@seattle.gov)

**Chao, Yaochiem**; SCL Standards Engineer and subject matter expert for 1561.09  
(yaochiem.chao@seattle.gov)

**Borek, Tom**; SCL Streetlight Engineer and subject matter expert for 1561.09  
(tom.borek@seattle.gov)

**Perander, Eivind**; SCL Service Engineer and subject matter expert for 1561.09  
(eivind.perander@seattle.gov)

**SCL Construction Standard 0222.02**; “Requirements for Duct Banks in the Public Right-of-Way”

**SCL Construction Standard 0224.07**; “Requirements for Secondary Conduits in the Right-of-Way”

**SCL Construction Standard 0233.05**; “Secondary Handhole Grounding”

**SCL Construction Standard 0461.10**; “Grounding Electrodes for Handholes and Vaults”

**SCL Construction Standard 0468.90**; “Exothermic Connection System”

**SCL Construction Standard U2-11.40/NDK-40**; “Mandreling and Cleaning of Ducts and Conduits”

**Zhuang, Liman**; SCL Service Engineer and subject matter expert for 1561.09  
(liman.zhuang@seattle.gov)

## Excavation in the Vicinity of Underground Transmission Lines



### 1. Scope

This work practice covers the requirements for excavation in the vicinity of underground transmission lines within the Seattle City Light (SCL) service territory. “In the vicinity” constitutes work that is within 15 ft of SCL transmission line infrastructure.

### 2. Application

This work practice provides direction to SCL crews, inspectors, reviewers, and contractors (“excavators”) who are involved with excavation activities in the vicinity of underground transmission lines.

### 3. Requirements

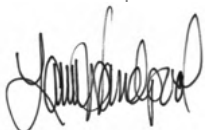
#### 3.1 General

Excavation shall meet the requirements of the latest revision of the City of Seattle Standard Specifications for Road, Bridge, and Municipal Construction, and all requirements listed in this standard. In cases of conflict, the most stringent requirements will prevail.

An SCL Safety Watch shall be onsite during the course of the excavation to oversee, inspect, and verify the excavator’s work.

The Safety Watch shall be either an underground Electrical Reviewer or Cable Splicer from the SCL Network Division. For details on the activities associated with the Safety Watch role, see Section 7.

Standards Coordinator  
Laura Vanderpool



Standards Supervisor  
John Shipek



Unit Director  
Andrew Strong



#### 4. Permits

The excavator shall obtain Right-of-Way permits as required by the Seattle Department of Transportation (SDOT).

---

#### 5. Financial Liability

The excavator shall be held financially responsible for any oil containment activities that result from excavation-related damage to SCL underground cables.

A Safety Watch shall be present for all work performed by excavator. The excavator shall be held liable for any damage found to SCL transmission line equipment in the event excavator performs any work without a Safety Watch present.

The excavator is solely responsible for avoiding SCL infrastructure, regardless of markings. As a warning to excavators, a yellow or red plastic tape with the message, "CAUTION Buried Electric Lines Below," may be present.

In some locations, a 3-in plastic communication conduit may be located 12 inches above the pipe cable transmission line and is considered part of the transmission line.

---

#### 6. Construction

##### 6.1 Prior to Start of Work

The excavator shall call the Utilities Underground Location Center (ULC) at 1-800-424-5555 to provide the location and the start date of the proposed work. Excavator shall call the ULC at least 10 working days in advance of the excavation.

The excavator shall also contact SCL directly to schedule a Safety Watch at least 10 working days in advance of the excavation at 206-684-4911 between 8 a.m. and 4 p.m. weekdays. For after-hours emergencies only, contact SCL at 206-684-4239.

The excavator shall submit a proposed plan and drawing for temporary support for the pipe cable or duct bank transmission line during excavation for review and approval by the Safety Watch. Temporary support shall:

- Provide isolation from vibration
- Be structurally adequate and provide non-conducting blocking for isolation and protection from damage
- Provide for adequate cooling and thermal expansion
- Have provisions for oil containment
- Include access for SCL along the transmission line for inspection and repair

##### 6.2 Start of Work

The foreman for the excavator shall warn their crew of the extreme danger to themselves by flash, explosion, electrocution, or fire likely to follow rupture of either the pipe or the duct bank. The pipe contains oil at up to 250 psi.

A tailgate meeting shall take place between the SCL Safety Watch and all crew working at the job site, on the first day of work, prior to start of work, and at least every workday thereafter, prior to start of work.

##### 6.3 Excavation Above the Transmission Line

The pavement above the pipe cable or duct bank may be opened using power-driven equipment.

#### 6.4 Excavation Near to and Below the Transmission Line

Excavation at this point shall be performed with hydro-excavation (vactor) methods only, using a suction hose with a soft tip.

##### **CAUTION!**

When excavating near a pipe-type transmission line, care should be taken to avoid spraying the pipe directly, which can cause significant damage to the coating! If the pipe is struck, SCL will test for any coating damage using a high voltage holiday detector. This test will be done just prior to thermal backfilling. Any coating repair will be made by SCL.

#### 6.5 Replacement of Thermal Backfill

In cases where underground marking tapes have not been encountered, the excavator shall install marking tape as part of the backfill operation, as follows: two strips, 18 inches below finish grade on opposite sides of the high-voltage line.

Two main scenarios exist for replacement of thermal backfill: backfill for pipe-type high-voltage lines and backfill for concrete-encased duct banks. Procedures for each are discussed in the following subsections.

##### 6.5.1. Backfill for Pipe-Type Transmission Lines

Pipe-type cable is completely encased in a special sand (thermal backfill) to ensure, as far as possible, uniform dissipation of the heat generated by the cables within the pipe. After the excavator has completed work in the vicinity of the pipe that disturbs the thermal backfill, and any needed repair of the coating has been made, the thermal backfill shall be replaced in accordance with the following procedure:

- Using Controlled Density Fill (CDF) trench backfill as described in SCL 7150.30, build up a foundation to a plane 12 inches below the bottom of the pipe. Compact the foundation.
- Using washed No. 2 sand, fill the trench until the lower half of the pipe is covered. Tamp (by hand) along the pipe on both sides until the sand underneath it supports the pipe. Discontinue tamping when the sand is firm and further tamping would tend to raise the pipe.
- Fill the trench with sand to at least 12 inches above the top of the pipe, tamping again for 96% compaction. The pipe should now be surrounded with 12 inches of sand in all directions extending from the pipe.
- Continue backfilling with CDF trench backfill to sub-grade.

##### 6.5.2. Backfill for Concrete-Encased Duct Bank-Type Transmission Lines

Backfill using low-strength fluidized thermal backfill (FTB) per SCL 7150.00.

---

#### 7. Inspection

The Safety Watch will inspect the following:

- Temporary support of pipe cable or duct bank transmission line
- Backfill materials and procedures
- Use of equipment at each phase of the excavation and installation of equipment
- Protective barriers

The Safety Watch will also inspect damage in the event the excavator strikes a pipe or duct bank, oversee testing of pipe coating, and coordinate repairs as necessary.

## 8. References

**City of Seattle Standard Specifications for Road, Bridge, and Municipal Construction**

**SCL Material Standard 7150.00**; “Fluidized Thermal Backfill”

**SCL Material Standard 7150.30**; “Controlled Density Fill”

---

## 9. Sources

**Abbott, Jeremy**; SCL Electrical Reviewer and subject matter expert for 1611.05

**Edwards, Tommy**; SCL Electrical Reviewer and subject matter expert for 1611.05

**SCL Construction Standard 0222.02**; “Requirements for Primary Conduit and Duct Bank Installation”

**Vanderpool, Laura**; SCL Technical Writer and Originator of 1611.05

# CONSTRUCTION STANDARD

## Clearances from Structures and Ground

**Notes:**

- 1 This standard covers only clearances from structures/objects. For working clearances for qualified workers, see WAC 296-5. For working clearances for unqualified workers, see WAC 296-155-428 and WAC 296-24-960.
- 2 For transmission lines, in addition to the additional clearance required by NESC-2002 Rule 232C1, Seattle City Light requires designs to add an extra 2 feet for construction tolerances.
- 3 Seattle City Light overhead triplex and quadruplex conductors are governed by NESC rule 230C3.

**Vertical Clearance of Wires, Conductors, and Cables Above Ground, Roadway, Rail, or Water Surfaces<sup>25</sup> (with final unloaded sag).**

Voltages are phase-to-ground for effectively grounded circuits and those other circuits where all ground faults are cleared by promptly de-energizing the faulted section, both initially and following subsequent breaker operations. See the definitions section for voltages of other systems. See Rules 232B1, 232C1a, and 232D4.

*References:*

NESC-2002, Table 232-1, Rule 232

nature of surface underneath wires, conductors, or cables	cables	triplex & quadruplex	supply	SCL nominal Ø-Ø system voltage: 26 kV & 34 kV	trolley and electrified railroad contact conductors and associated span or messenger wires	
	insulated communication conductors and cable; messengers; surge-protection wires; grounded guys; ungrounded guys exposed to 0 to 300 V <sup>11, 15</sup> ; neutral conductors meeting Rule 230E1; supply cables meeting Rule 230C1 ft.	non-insulated communication conductors; supply cables of 0 to 750 V meeting Rules 230C2 or 230C3 ft.	supply cables over 750 V meeting Rules 230C2 or 230C3; open supply conductors, 0 to 750 V; ungrounded guys exposed to over 300 V to 750 V <sup>14</sup> ft.	open supply conductors, over 750 V to 22 kV; ungrounded guys exposed to 750 V to 22 kV <sup>14</sup> ft.	0 to 750 V to ground ft.	over 750 V to 22 kV to ground ft.
<b>Where wires, conductors, or cables cross over or overhang</b>						
1. Track rails of railroads (except electrified railroads using overhead trolley conductors) <sup>2,16,22</sup>	23.5	24.0	24.5	26.5	22.0 <sup>4</sup>	22.0 <sup>4</sup>
2. Roads, streets, and other areas subject to truck traffic <sup>23</sup>	15.5	16.0	16.5	18.5	18.0 <sup>5</sup>	20.0 <sup>5</sup>
3. Driveways, parking lots, and alleys <sup>23</sup>	15.5 <sup>7,13</sup>	16.0 <sup>7,13</sup>	16.5 <sup>7</sup>	18.5	18.0 <sup>5</sup>	20.0 <sup>5</sup>
4. Other land traversed by vehicles, such as cultivated, grazing, forest, orchards, etc. <sup>26</sup>	15.5	16.0	16.5	18.5	–	–
5. Spaces and ways subject to pedestrians or restricted traffic only <sup>9</sup>	9.5	12.0 <sup>8</sup>	12.5 <sup>8</sup>	14.5	16.0	18.0

Standards Coordinator  
Curtis Lu

Standards Supervisor  
John Shipek

Unit Director  
Darnell Cola







**CONSTRUCTION STANDARD**

Clearances from Structures and Ground

standard number: **D2-3**

superseding: April 6, 2016

effective date: January 30, 2018

page: 2 of 8

**Vertical Clearance of Wires, Conductors, and Cables Above Ground, Roadway, Rail, or Water Surfaces<sup>25</sup> (with final unloaded sag).**

*References:*

*NESC-2002, Table 232-1, Rule 232*

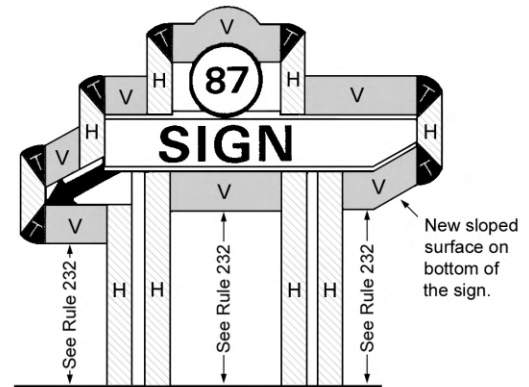
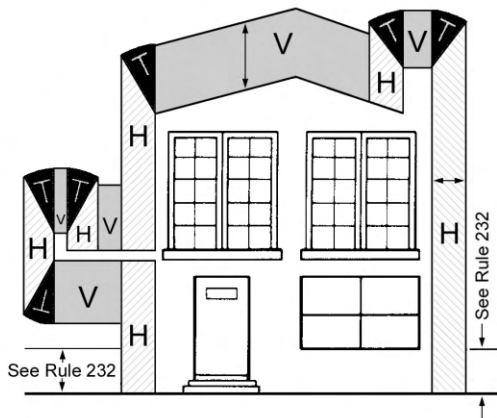
nature of surface underneath wires, conductors, or cables	cables	triplex & quadruplex	supply	SCL nominal Ø-Ø system voltage: 26 kV & 34 kV	trolley and electrified railroad contact conductors and associated span or messenger wires	
	insulated communication conductors and cable; messengers; surge-protection wires; grounded guys; ungrounded guys exposed to 0 to 300 V <sup>11, 15</sup> ; neutral conductors meeting Rule 230E1; supply cables meeting Rule 230C1 ft.	noninsulated communication conductors; supply cables of 0 to 750 V meeting Rules 230C2 or 230C3 ft.	supply cables over 750 V meeting Rules 230C2 or 230C3; open supply conductors, 0 to 750 V; ungrounded guys exposed to over 300 V to 750 V <sup>14</sup> ft.	open supply conductors, over 750 V to 22 kV; ungrounded guys exposed to 750 V to 22 kV <sup>14</sup> ft.	0 to 750 V to ground ft.	over 750 V to 22 kV to ground ft.
<b>Where wires, conductors, or cables cross over or overhang</b>						
6. Water areas not suitable for sailboating or where sailboating is prohibited <sup>21</sup>	14.0	14.5	15.0	17.0	–	–
7. Water areas suitable for sailboating including lakes, ponds, reservoirs, tidal waters, rivers, streams, and canals with an unobstructed surface area of <sup>17, 18, 19, 20, 21</sup>						
a. Less than 20 acres	17.5	18.0	18.5	20.5	–	–
b. Over 20 to 200 acres	25.5	26.0	26.5	28.5	–	–
c. Over 200 to 2000 acres	31.5	32.0	32.5	34.5	–	–
d. Over 2000 acres	37.5	38.0	38.5	40.5	–	–
8. Established boat ramps and associated rigging areas; areas posted with sign(s) for rigging or launching sailboats	Clearance above ground shall be 5 ft greater than in 7 above, for the type of water areas served by the launching site					
<b>Where wires, conductors, or cables run along and within the limits of highways or other road rights-of-way but do not overhang the roadway</b>						
9. Roads, streets, or alleys	15.5 <sup>24</sup>	16.0	16.5	18.5	18.0 <sup>5</sup>	20.0 <sup>5</sup>
10. Roads in rural districts where it is unlikely that vehicles will be crossing under the line	13.5 <sup>10, 12</sup>	14.0 <sup>10</sup>	14.5 <sup>10</sup>	16.5	18.0 <sup>5</sup>	20.0 <sup>5</sup>

**Notes for tables on pages 1 and 2**

- 1** Where subways, tunnels, or bridges require it, less clearance above ground or rails than required by Table 232-1 may be used locally. The trolley and electrified railroad contact conductor should be graded very gradually from the regular construction down to the reduced elevation.
- 2** For wires, conductors, or cables crossing over mine, logging, and similar railways that handle only cars lower than standard freight cars, the clearance may be reduced by an amount equal to the difference in height between the highest loaded car handled and 20 ft, but the clearance shall not be reduced below that required for street crossings.
- 3** This footnote not used in this edition.
- 2** In communities where 21 ft has been established, this clearance may be continued if carefully maintained. The elevation of the contact conductor should be the same in the crossing and next adjacent spans. (See Rule 225D2 for conditions that must be met where uniform height above rail is impractical.)
- 5** In communities where 16 ft has been established for trolley and electrified railroad contact conductors 0 to 750 V to ground, or 18 ft for trolley and electrified railroad contact conductors exceeding 750 V, or where local conditions make it impractical to obtain the clearance given in the table, these reduced clearances may be used if carefully maintained.
- 6** This footnote not used in this edition.
- 7** Where the height of a building or other installation does not permit service drops to meet these values, the clearances over residential driveways only may be reduced to the following:
- |  | (feet) |
|--|--------|
| (a) Insulated supply service drops limited to 300 V to ground                                    | 12.5   |
| (b) Insulated drip loops of supply service drops limited to 300 V to ground                      | 10.5   |
| (c) Supply service drops limited to 150 V to ground and meeting Rules 230C1 or 230C3             | 12.0   |
| (d) Drip loops only of service drops limited to 150 V to ground and meeting Rules 230C1 or 230C3 | 10.0   |
| (e) Insulated communication service drops  | 11.5   |
- 8** Where the height of a building or other installation does not permit service drops to meet these values, the clearances may be reduced to the following:
- |   | (feet) |
|---|--------|
| (a) Insulated supply service drops limited to 300 V to ground   | 10.5   |
| (b) Insulated drip loops of supply service drops limited to 300 V to ground                             | 10.5   |
| (c) Supply service drops limited to 150 V to ground and meeting Rules 230C1 or 230C3                    | 10.0   |
| (d) Drip loops only of supply service drops limited to 150 V to ground and meeting Rules 230C1 or 230C3 | 10.0   |
- 9** Spaces and ways subject to pedestrians or restricted traffic only are those areas where riders on horses or other large animals, vehicles, or other mobile units exceeding a total height of 8 ft are prohibited by regulation or permanent terrain configurations, or are otherwise not normally encountered nor reasonably anticipated.
- 10** Where a supply or communication line along a road is located relative to fences, ditches, embankments, etc., so that the ground under the line would not be expected to be traveled except by pedestrians, the clearances may be reduced to the following values: (see top of next column)
- |   | (feet) |
|---|--------|
| (a) Insulated communication conductor and communication cables.   | 9.5    |
| (b) Conductors of other communication circuits  | 9.5    |
| (c) Supply cables of any voltage meeting Rule 230C1, supply cables limited to 150 V to ground meeting Rules 230C2 or 230C3, and neutral conductors meeting Rule 230E1 | 9.5    |
| (d) Insulated supply conductors limited to 300 V to ground  | 12.5   |
| (e) Guys  | 9.5    |
- 11** No clearance from ground is required for anchor guys not crossing tracks, rails, streets, driveways, roads, or pathways.
- 12** This clearance may be reduced to 13 ft for communication conductors and guys.
- 13** Where this construction crosses over or runs along alleys, driveways, or parking lots not subject to truck traffic this clearance may be reduced to 15 ft.
- 14** Ungrounded guys and ungrounded portions of span guys between guy insulators shall have clearances based on the highest voltage to which they may be exposed due to a slack conductor or guy.
- 15** Anchor guys insulated in accordance with Rule 279 may have the same clearance as grounded guys.
- 16** Adjacent to tunnels and overhead bridges that restrict the height of loaded rail cars to less than 20 ft, these clearances may be reduced by the difference between the highest loaded rail car handled and 20 ft, if mutually agreed to by the parties at interest.
- 17** For controlled impoundments, the surface area and corresponding clearances shall be based upon the design high-water level.
- 18** For uncontrolled water flow areas, the surface area shall be that enclosed by its annual high-water mark. Clearances shall be based on the normal flood level; if available, the 10-year flood level may be assumed as the normal flood level.
- 19** The clearance over rivers, streams, and canals shall be based upon the largest surface area of any 1-mile-long segment that includes the crossing. The clearance over a canal, river, or stream normally used to provide access for sailboats to a larger body of water shall be the same as that required for the larger body of water.

- 20 Where an overwater obstruction restricts vessel height to less than the applicable reference height given in Table 232-3, the required clearance may be reduced by the difference between the reference height and the overwater obstruction height, except that the reduced clearance shall be not less than that required for the surface area on the line-crossing side of the obstruction.
- 21 Where the US Army Corps of Engineers, or the state, or surrogate thereof has issued a crossing permit, clearances of that permit shall govern.
- 22 See Rule 234I for the required horizontal and diagonal clearances to rail cars.
- 23 For the purpose of this Rule, trucks are defined as any vehicle exceeding 8 ft in height. Areas not subject to truck traffic are areas where truck traffic is not normally encountered nor reasonably anticipated.
- 24 Communication cables and conductors may have a clearance of 15 ft where poles are back of curbs or other deterrents to vehicular traffic.

- 25 The clearance values shown in this table are computed by adding the applicable Mechanical and Electrical (M & E) value of Table A-1 to the applicable Reference Component of Table A-2a of Appendix A.
- 26 When designing a line to accommodate oversized vehicles, these clearance values shall be increased by the difference between the known height of the oversized vehicle and 14 ft.



**Legend**

regions where conductors are prohibited	controlling clearance
H	Horizontal
V	Vertical
T	Transitional = Vertical (Arc)

**control criteria**

With wire, conductor, or cable displaced from the rest by a six-pound-per-square-foot wind force at final sag at 60° F.

With final unloaded sag in the wire, conductor, or cable.

Reference: NESC-2002 Fig. 234-1

**CONSTRUCTION STANDARD**

Clearances from Structures and Ground

**Clearance of Wires, Conductors, Cables, and Unguarded Rigid Live Parts Adjacent but Not Attached to Buildings and Other Installations Except Bridges<sup>12</sup>**

Voltages are phase to ground for effectively grounded circuits and those other circuits where all ground faults are cleared by promptly de-energizing the faulted section, both initially and following subsequent breaker operations. See the definitions section for voltages of other systems. Clearances are with no wind displacement except where stated in the footnotes below. See Rules 234C1a, 234C2, and 234H4.

References: NESC-2002,  
Table 234-1, Rule 234

clearance of	insulated communication conductors and cables; messengers; surge-protection wires; grounded guys; ungrounded guys exposed to 0 to 300 V <sup>12</sup> ; neutral conductors meeting Rule 230E1; supply cables meeting Rule 230C1 <sup>5</sup> ft.	Triplex & Quadplex				SCL nominal Ø-Ø system voltage
		under 750 V plus	over 750 V plus	under 750 V plus	over 750 V plus	
		supply cables of 0 to 750 V meeting Rules 230C2 or 230C3 ft.	unguarded rigid live parts 0 to 750 V; non-insulated communication conductors; ungrounded equipment cases, 0 to 750V; ungrounded guys exposed to open supply conductors of over 300 V to 750 V <sup>5</sup> ft.	supply cables over 750 V meeting Rules 230C2 or 230C3; open supply conductors, 0 to 750 V ft.	unguarded rigid live parts, over 750 V to 22 kV; ungrounded equipment cases, 750 V to 22 kV; ungrounded guys exposed to over 750 V to 22 kV <sup>5</sup> ft.	Open supply conductors, over 750 V to 22 kV ft.  26 kV & 34 kV
<b>1. Buildings</b>						
<b>a. Horizontal</b>						
(1) To walls, projections, and guarded windows	4.5 <sup>1, 2, 7</sup>	5.0 <sup>1, 2</sup>	5.0 <sup>1, 2</sup>	5.5 <sup>1, 2, 9</sup>	7.0 <sup>1, 2</sup>	14.0 <sup>14</sup>
(2) To unguarded windows <sup>8</sup>	4.5	5.0	5.0	5.5 <sup>9</sup>	7.0	14.0 <sup>14</sup>
(3) To balconies and areas readily accessible to pedestrians <sup>3</sup>	4.5	5.0	5.0	5.5 <sup>9</sup>	7.0	14.0 <sup>14</sup>
<b>b. Vertical<sup>14</sup></b>						
(1) Over or under roofs or projections not readily accessible to pedestrians <sup>3</sup>	3.0	3.5	10.0	10.5	12.0	14.0 <sup>14</sup>
(2) Over or under balconies and roofs readily accessible to pedestrians <sup>3</sup>	10.5	11.0	11.0	11.5	13.0	14.0 <sup>14</sup>
(3) Over roofs accessible to vehicles but not subject to truck traffic <sup>6</sup>	10.5	11.0	11.0	11.5	13.0	14.0 <sup>14</sup>
(4) Over roofs accessible to truck traffic <sup>6</sup>	15.5	16.0	16.0	16.5	18.0	18.5
<b>2. Other Installations not classified as buildings or bridges</b>						
<b>a. Horizontal<sup>4</sup></b>						
(1) To portions that are readily accessible to pedestrians <sup>3</sup>	4.5	5.0	5.0 <sup>1, 2</sup>	5.5 <sup>9</sup>	7.0 <sup>1, 2</sup>	14.0 <sup>14</sup>
(2) To portions that are not readily accessible to pedestrians <sup>3</sup>	3.0	3.5	5.0 <sup>1, 2</sup>	5.5 <sup>1, 2, 9</sup>	7.0 <sup>1, 2</sup>	14.0 <sup>14</sup>
<b>b. Vertical</b>						
(1) Over or under catwalks and other surfaces upon which personnel walk	10.5	11.0	11.0	11.5	13.0	14.0 <sup>14</sup>
(2) Over or under other portions of such installations <sup>4</sup>	3.0	3.5	5.5	6.0 <sup>1</sup>	7.5	14.0 <sup>14</sup>

**CONSTRUCTION STANDARD**

Clearances from Structures and Ground

standard number: **D2-3**

superseding: April 6, 2016

effective date: January 30, 2018

page: 6 of 8

**Notes for table on page 5**

- 1 Where building, sign, chimney, antenna, tank, or other installation does not require maintenance such as painting, washing, changing of sign letters, or other operations that would require persons to work or pass between wires, conductors, cables or unguarded rigid live parts and structure, the clearance may be reduced by 2 ft.
- 2 Where available space will not permit this value, the clearance may be reduced by 2 ft provided the wires, conductors, or cables, including splices and taps, and unguarded rigid live parts have a covering that provides sufficient dielectric strength to limit the likelihood of a short circuit in case of momentary contact with a structure or building.
- 3 A roof, balcony, or area is considered readily accessible to pedestrians if it can be casually accessed through a doorway, ramp, window, stairway, or permanently mounted ladder by a person on foot who neither exerts extraordinary physical effort nor employs special tools or devices to gain entry. A permanently mounted ladder is not considered a means of access if its bottom is 8 ft or more from the ground or other permanently installed accessible surface.
- 4 The required clearances shall be to the closest approach of motorized signs or moving portions of installations covered by Rule 234C.
- 5 Ungrounded guys and ungrounded portion of guys between guy insulators shall have clearances based on the highest voltage to which they may be exposed to a slack conductor or guy.
- 6 For the purpose of this rule, trucks are defined as any vehicle exceeding 8 ft in height.
- 7 This clearance may be reduced to 3 in for the grounded portions of guys.
- 8 Windows not designed to open may have the clearances permitted for walls and projections.
- 9 The clearance at rest shall be not less than the value shown in this table. Also, when the conductor or cable is displaced by wind, the clearance shall be not less than 3.5 ft; see Rule 234C1b.
- 10 Where available space will not permit this value, the clearance may be reduced to 7.0 ft for conductors limited to 8.7 kV to ground.
- 11 The clearance values shown in this table are computed by adding the applicable Mechanical and Electrical (M & E) value of Table A-1 to the applicable Reference Component of Table A-2b of Appendix A.
- 12 The anchor end of guys insulated in accordance with Rule 279 may have the same clearance as grounded guys.
- 13 For clearances above railings, walls, or parapets around balconies or roofs, use the clearances required for row 1b (1). For such clearances where an outside stairway exists, use the clearances required for row 2b (2).
- 14 Seattle City Light policy is that the clearance shall be 10 feet (WAC 296-155-428) plus 4 feet for maintenance and construction of building surfaces.

**Clearance of Wires, Conductors, Cables, and Unguarded Rigid Live Parts from Bridges**

Voltages are phase to ground for effectively grounded circuits and those other circuits where all ground faults are cleared by promptly de-energizing the faulted section, both initially and following subsequent breaker operations. See the definitions section for voltages of other systems. Clearances are with no wind displacement except where stated in the footnotes below. See Rules 234D1a and 234H4.

References: NESC-2002,  
Table 234-2, Rule 234

clearance	triplex & quadruplex	supply	unguarded or ungrounded plus	SCL nominal Ø-Ø system voltage
	unguarded rigid live parts 0 to 750 V; non-insulated communication conductors; supply cables of 0 to 750 V meeting Rules 230C2 or 230C3 <sup>7</sup>		unguarded rigid live parts, over 750 V to 22 kV; ungrounded equipment cases, 750 V to 22 kV; ungrounded guys exposed to open supply conductors of over 750 V to 22 kV <sup>4</sup> ft.	open supply conductors, over 750 V to 22 kV
	ungrounded equipment cases, 0 to 750V; ungrounded guys exposed to open supply conductors over 300 V to 750 V <sup>4</sup> ft.	supply cables over 750 V meeting Rules 230C2 or 230C3 <sup>7</sup> , open supply conductors, 0 to 750 V ft.		26 kV & 34 kV ft.
<b>1. Over bridges <sup>1</sup></b>				
<b>a. Attached <sup>3</sup></b>	3.0	3.5	5.0	14.0 <sup>10</sup>
<b>b. Not attached</b>	10.0	10.5	12.0	14.0 <sup>10</sup>
<b>2. Beside, under, or within bridge structure <sup>6</sup></b>				
<b>a. Readily accessible portions of any bridge including wing, walls, and bridge attachments <sup>1</sup></b>				
(1) Attached <sup>3</sup>	3.0	3.5 <sup>8</sup>	5.0	14.0 <sup>10</sup>
(2) Not attached	5.0	5.5 <sup>8</sup>	7.0	14.0 <sup>10</sup>
<b>b. Ordinarily inaccessible portions of bridges (other than brick, concrete, or masonry) and from abutments <sup>2</sup></b>				
(1) Attached <sup>3,5</sup>	3.0	3.5 <sup>8</sup>	5.0	14.0 <sup>10</sup>
(2) Not attached <sup>4,5</sup>	4.0	4.5 <sup>8</sup>	6.0	14.0 <sup>10</sup>

- 1 Where over traveled ways on or near bridges, the clearances of Rule 232 apply also.
- 2 Bridge seats of steel bridges carried on masonry, brick, or concrete abutments that require frequent access for inspection shall be considered as readily accessible portions.
- 3 Clearance from supply conductors to supporting arms and brackets attached to bridges shall be the same as specified in Table 235-6 (Rule 235E1) if the supporting arms and brackets are owned, operated, or maintained by the same utility
- 4 Ungrounded guys and ungrounded portions of guys between guy insulators shall have clearances based on the highest voltage to which they may be exposed due to a slack conductor or guy.
- 5 Where conductors passing under bridges are adequately guarded against contact by unauthorized persons and can be de-energized and grounded per Rule 444D for maintenance of the bridge, clearances of the conductors from the bridge, at any point, may have the clearances specified in Table 235-6 for clearance from surfaces of

- support arms plus one-half the final unloaded sag of the conductor at that point.
- 6 Where the bridge has moving parts, such as a lift bridge, the required clearances shall be maintained throughout the full range of movement of the bridge or any attachment thereto.
- 7 Where permitted by the bridge owner, supply cables may be run in rigid conduit attached directly to the bridge. Refer to Part 3 for installation rules.
- 8 The clearance at rest shall be not less than the value shown in this table. Also, when the conductor or cable is displaced by wind, the clearance shall be not less than 3.5 ft; see Rule 234D1b.
- 9 The clearance at rest shall be not less than the value shown in this table. Also, when the conductor or cable is displaced by wind, the clearance shall be not less than 4.5 ft; see Rule 234D1b.
- 10 Seattle City Light policy is that the clearance shall be 10 feet (WAC 296-155-428) plus 4 feet for maintenance and construction of building surfaces.

**CONSTRUCTION STANDARD**

Clearances from Structures and Ground

standard number: **D2-3**

superseding: April 6, 2016

effective date: January 30, 2018

page: 8 of 8

**Clearances - State Highways**

The vertical clearance for overhead power and communication lines above the highway and the lateral and vertical clearance from bridges shall conform with the National Electrical Safety Code and/or with the clearances as shown below, whichever is greater.

Reference: WAC 468-34-290 (Wash. DOT - Utility Lines - Franchises and Permits)

type of utility line	vertical clearance	
	lines crossing roadways, ft.	longitudinal, ft.
Communications and Cable Television	24	20
Communications and/or Cable Television Joint Usage with Electrical	20	20

Reference: WAC 468-34-290 (Wash. DOT - Utility Lines - Franchises and Permits)

electrical phase-to-ground voltage	SCL nominal Ø-Ø system voltage	vertical clearance	
		lines crossing roadways, ft.	longitudinal, ft.
0 - 750 volts	–	24	24
751 - 15,000 volts	–	30	27
15,001 - 50,000 volts	26 kV & 34 kV	32	32
50,001 volts and over	–	34	32

**Notes for State highway clearances**

- 1 The minimum height of highway crossings shall be measured from the point of the roadway directly under the crossing.
- 2 The minimum height of longitudinal lines shall be measured from ground line.
- 3 All clearances shall be at State Electrical Construction Code temperature and loading standards, and comply with all other requirements of this code.

**Definition of terms**

Reference: WAC 468-34-110

Unless otherwise stated, words and phrases used herein shall have the following meaning:

- 1 Highway – A general term denoting a street, road or public way for purposes of vehicular travel, including the entire area within the right of way.
- 2 Roadway – The portion of a highway including shoulders, for vehicular use. A divided highway has two or more roadways.
- 3 SCL – Seattle City Light

## Pulling Iron Installation for In-Building Vaults, Network System



### 1. Scope

This standard covers proper installation of pulling irons during construction of in-building vaults to facilitate pulling Seattle City Light (SCL) electrical cable. The number, location, and height shall be determined for each project by the SCL engineer. The pulling irons are not intended to be used to pull out lodged cable or to move heavy equipment.

### 2. Application

This standard provides requirements for the installation of pulling irons (also known as pulling eyes, item 1 in the material list).

A form (item 2 in the material list) is used to create the pulling iron recess.

A cover (item 3 in the material list) is used to conceal the floor-mounted pulling irons.

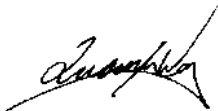
This standard is intended for use by SCL engineers, SCL inspectors, SCL civil crews, and contractors who approve, inspect, build, and construct in-building and cast-in-place vaults.

Additional Network vault requirements are found in SCL NVH-80. SCL U1-4.11/NCI-60 describes cable pulling tension calculations.

### 3. Material List

Item	Description	Stock No.	Quantity
1	Pulling iron, stainless steel	720235	Project specific
2	Form for embedded pulling iron	013525	"
3	Pulling iron cover	720236	"

Standards Coordinator  
Quan Wang



Standards Supervisor  
John Shipek



Unit Director  
Andrew Strong





#### 4. SCL Civil Engineering Review Requirement

SCL Civil Engineering needs to review the pulling iron design if:

1. It is a retrofit (pulling iron installed on existing wall/ceiling/floor). If so, design calculation and pull test are both required.
2. The pulling iron is other than SCL stock number 720235. Other pulling irons will require design calculation and pull test for new and retrofit installation.

#### 5. Installation Notes

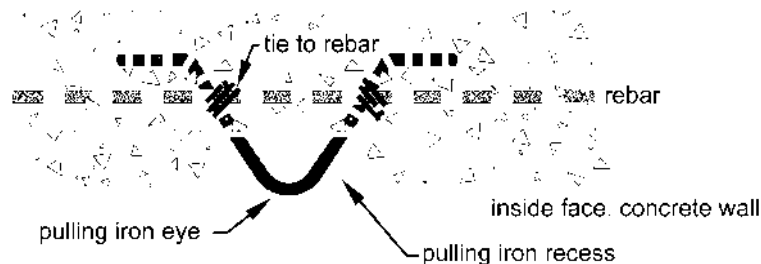
##### 5.1 General

The following requirements shall be met when installing pulling irons:

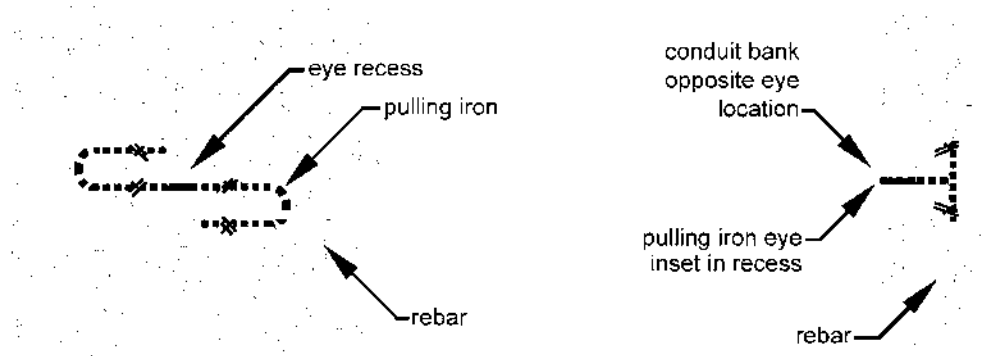
- Pulling irons shall be installed behind concrete reinforcing steel (rebar). See Figure 5b.
- Spacing and size of rebar shall be determined by a licensed civil engineer.
- Pulling irons shall be tied to the rebar.
- Pulling iron installation shall be rated and labeled in the vault as 5000 lb maximum working tension.
- The vault wall, ceiling, and floor shall be designed so that each pulling iron obtains a 10,000-lb ultimate strength.
- Rubber forms shall be used to create the pulling iron recess shown in Figure 5a.
- If a pulling iron is installed in the floor, install a recessed pulling iron cover to avoid a tripping hazard.
- Pulling iron embedment detail is required in the vault layout drawings for new and retrofit installation.

Figures 5a and 5b show a pulling iron embedded in a concrete vault, behind and tied to rebar. Pulling irons are typically opposite the entry or conduit entrance.

**Figure 5a. Pulling Iron, Inset View**



**Figure 5b. Pulling Iron, Vault Interior, Front and Side Views**



## 5.2 Installation in New Construction

Pulling irons for rigging equipment shall be installed minimally, without duplication, and as follows:

- Opposite each conduit entrance at approximately the same height.
- Inset into a recess in the vault wall so that the eye is exposed and flush with the interior wall. See Figure 5b.

Locations for pulling irons can vary depending on the vault plan and configuration (entry door, conduit entrance, hatch, and transformer locations). SCL prefers that pulling irons on walls shall optimally match the height of the conduits, or as the next preferred option, the pulling iron shall be just below the conduit entrance.

If the vault is constructed of concrete blocks, with engineering pre-approval irons may be floor-mounted. One pulling iron cover shall be provided for each pulling iron installed in the vault floor.

## 5.3 Installation on an Existing Wall (Retrofit)

Installation of a pulling iron on an existing vault wall shall meet the following requirements:

- Pulling iron and wall design calculation and drawings shall be stamped by a licensed Civil Engineering PE. These calculations and drawings shall be submitted to SCL for review and approval.
- Drawing detail shall include pulling iron detail, anchor detail, and existing wall details, as well as layout of the pulling iron and the cable entrance.
- The concrete masonry unit (CMU) wall that a pulling iron will be anchored to shall be fully grouted.
- A pulling test shall be required for any pulling iron installed on an existing wall.
- Pulling iron installation shall meet a minimum testing load of 7500 lb.

---

## 6. Labeling

Using a stencil, paint 2-inch tall letters near the pulling iron indicating “5000 LB MAX. WORKING.”

---

## 7. References

**SCL Construction Guideline U1-4.11/NCI-60**; “Cable Pulling Calculations: Maximum Pulling Tensions for Installing Electrical Wire and Cables (Underground)”

**SCL Construction Guideline NVH-80**; “Network Area Requirements for Panel or Cast-In-Place Vaults”

---

## 8. Sources

**Lee, Dennis**; Network Service Supervisor, subject matter expert, and originator of NCI-62 (dennis.lee@seattle.gov)

**Ng, Sharon**; Sr. Civil Engineer and subject matter expert for NCI-62 (sharon.ng@seattle.gov)

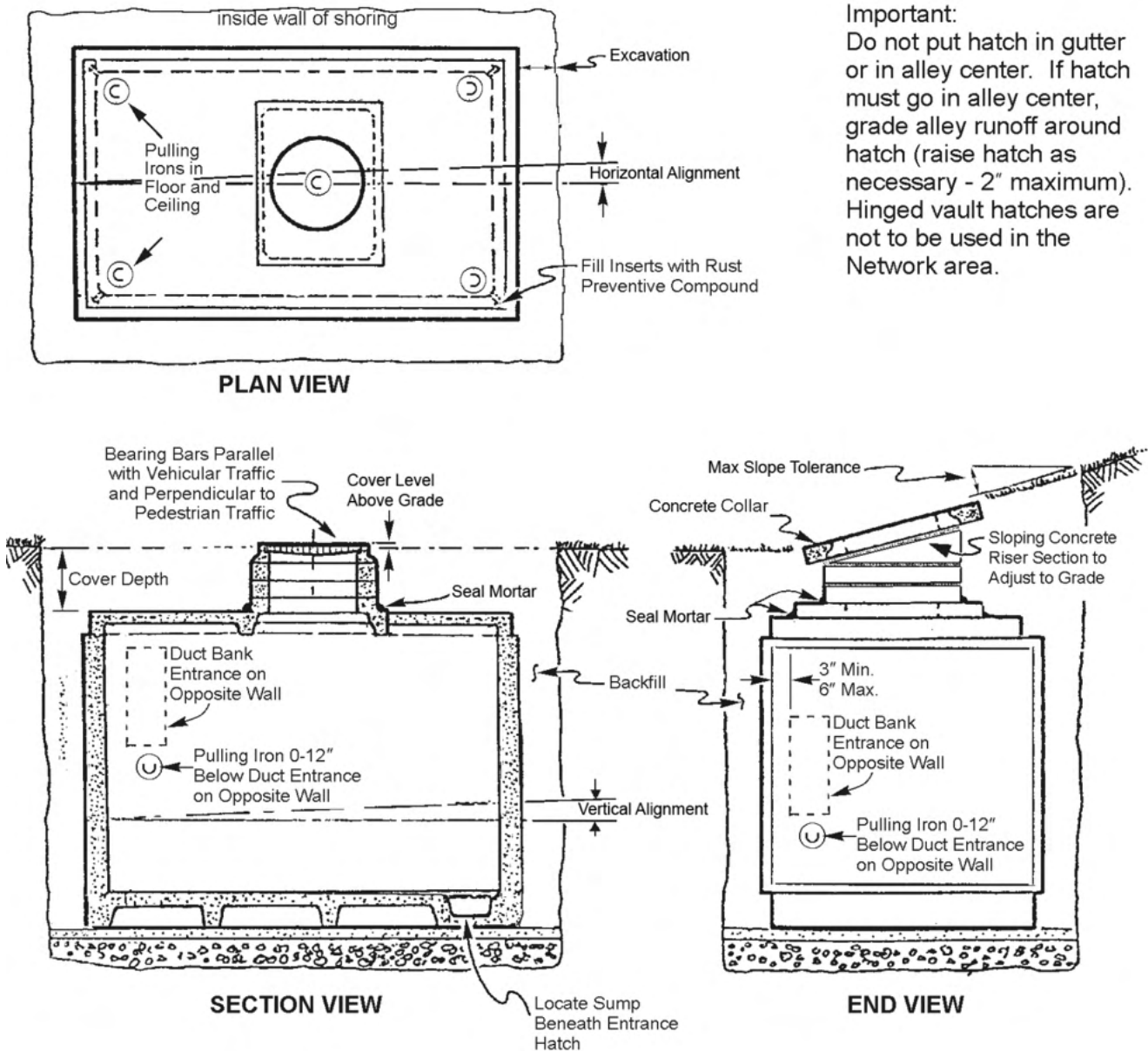
**Siddiqi, Uzma**; SCL Standards Engineer and subject matter expert for NCI-62 (uzma.siddiqi@seattle.gov)

**Youngs, Rob**; Crew Chief and subject matter expert for NCI-62 (rob.youngs@seattle.gov)

## Network Area Requirements for Panel or Cast-in-Place Vaults

**Figure 1, Typical Vault Installation**

Vault configurations vary. Ring vaults are not acceptable in the Network area.



Standard Coordinator  
 Brett Hanson

Standards Engineering Supervisor  
 John Shipek

Division Director  
 Andrew Strong

## 1. Codes

All work, including shoring and bracing, shall be in compliance with the latest editions of:

- 1.1 State of Washington Department of Labor and Industries WAC Chapter 296-46B-450, "Equipment for General Use – Transformers and Transformer Vaults"
- 1.2 State of Washington Department of Labor and Industries Chapter 296-155 WAC "Safety Standards for Construction Work"
- 1.3 Seattle Building Code Section 422 "Private and Utility Transformer Vaults"
- 1.4 SDOT Director's Rule 2004 – 02, "Street and Sidewalk Pavement Opening and Restoration Rules"

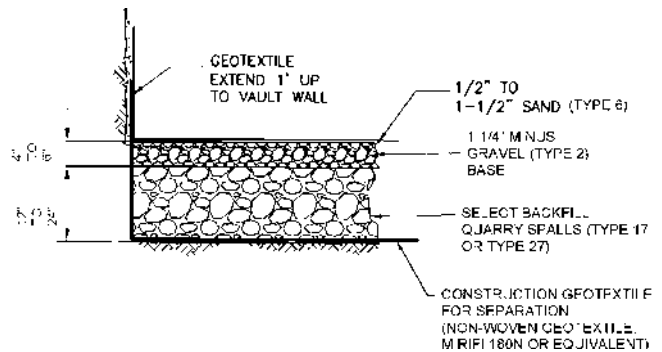
## 2. Excavation

- 2.1 Excavate so there is 36 inches between ends and sides of vault and the vertical sides of excavation or shoring unless larger excavation is authorized by the Engineer.
- 2.2 Remove shoring before backfilling.
- 2.3 If excavation bottom is saturated prior to placing bedding material, then over-excavate area as directed by the Engineer and place cobbles (3-inch to 8-inch stone — no broken concrete).

## 3. Bedding

- 3.1 The bedding material shall consist of 4 inches to 12 inches of stable base material, 1-1/4 inch minus gravel (Type 2).
- 3.2 If the excavation bottom is saturated or consists of inadequate bearing material, then over-excavate area as directed by the SCL engineer and place a construction geotextile at the bottom, then 12 to 24 inches of quarry spalls (Select backfill Type 17 or 27). See Figure 3.
- 3.3 If excavation bottom is not saturated and consists of adequate bearing material prior to placing bedding material, compact bottom of excavation with two full compacting operations at right angles to each other with a mechanical compactor.
- 3.4 Place a layer of crushed rock 1-1/4 inch minus gravel (Type 2), screed and compact to a minimum thickness of 4 inches and add 1/2 to 1-1/2 inches of sand (Type 6) to create a level surface.

**Figure 3. Over-Excavation Detail**



## 4. Vault Entrance

### 4.1 Hatch

- 4.1.1 For transformer vaults, the hatch shall be specified.
- 4.1.2 Personnel hatches shall be 42 inches-round.
- 4.1.3 Covers for non-transformer vaults shall be H-20 solid unless otherwise specified.
- 4.1.4 Entrance and transformer openings for future transformer vaults shall be covered with H-20 solid covers until the transformers are installed.
- 4.1.5 Do not install hinged covers on permanent installations.
- 4.1.6 All covers (other than vented grates) shall have a slip-resistant surface, which has been approved by City Light Standards.
- 4.1.7 Where pulling problems are anticipated, such as pulling from both ends, it may be useful to design the vault with two hatches.

### 4.2 Hatch Location

- 4.2.1 Hatches shall not be in the gutter line or center of alley to protect electrical workers from surface water draining into the vault.
- 4.2.2 Put hatch 18 inches minimum away from curb line.

### 4.3 Hatch Relation to Vault Wall

- 4.3.1 The edge of the hatch openings shall be 36 inches from any vault wall, minimum.
- 4.3.2 Hatches shall be centered in vault ceiling if possible.

**4.4 Grade and Risers**

- 4.4.1 When adjusting the vault entrance to a sloping grade, install a sloping riser section and a poured-in-place collar. Do not use brick and mortar slope adjustments if possible. Minimize the use of mortar adjustments and in no case shall the mortar thickness exceed one inch. For in-street use, a properly engineered sloping riser section is required.
- 4.4.2 Whenever the final grade of the hatch exceeds 10% (6 degree slope), the hinge side of the personnel hatch shall be located on the downhill side.
- 4.4.3 Maximum slope of frame and grate shall not exceed 2 inches in 12 inches without permission of Engineer.
- 4.4.4 Set on riser in one inch of mortar (1 part cement to three parts sand with polyvinyl acetate bonding agent).
- 4.4.5 Where the riser section is specified at 12 inches deep or more, order a length of Unistrut cast into the side wall of the riser.

- 4.4.6 Adjust between 1/4 inch and 3/8 inch above grade to prevent water from entering vault, but not to cause a hazard. Ramp concrete to top of frame for gradual transition.

**4.5 Frame**

- 4.5.1 For transformer vaults the frame shall be specified.
- 4.5.2 Frames shall be H-20+ (extra heavy) suitable for bus traffic and special applications.

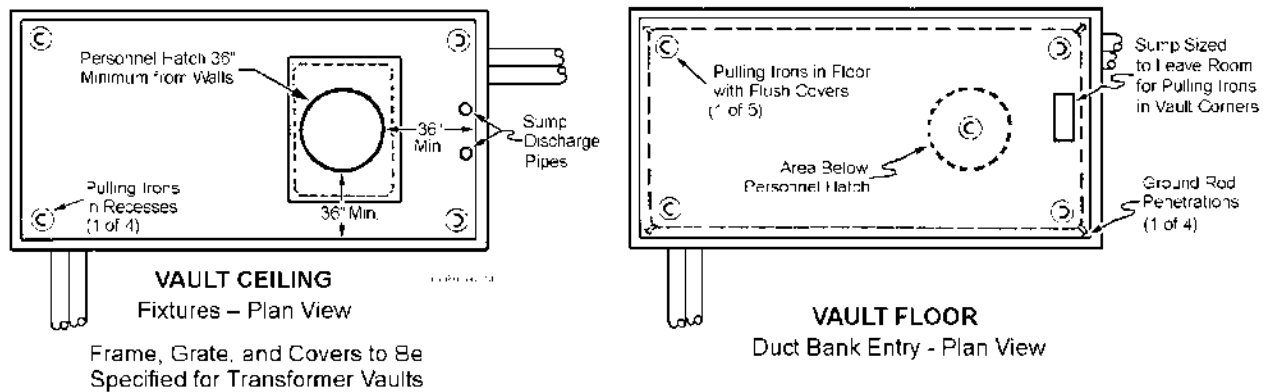
**4.6 Concrete Collar**

See SCL 0223.33.

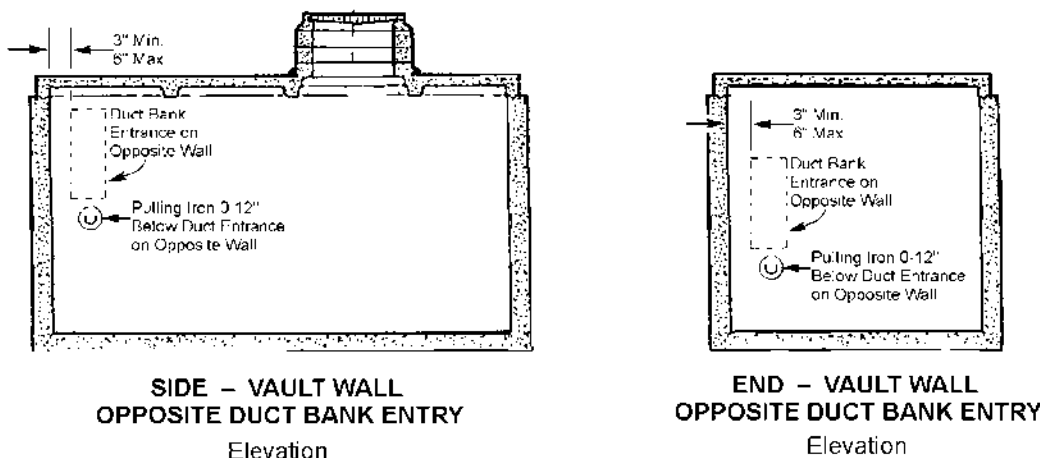
**5. Pulling Irons**

- 5.1 All pulling irons shall be stainless steel.
- 5.2 All pulling irons shall be recessed; pulling irons in the vault floor shall be equipped with a flush removable cover.
- 5.3 If the vault has more than one personnel hatch, place pulling irons beneath each personnel hatch.
- 5.4 If a floor section seam is below the personnel hatch, place one pulling iron in each floor section.

**Figure 5.1, plan views**



**Figure 5.2, elevation views**



## 5. Pulling Irons, continued

- 5.5** Install pulling irons in the following locations:
- 5.5.1 Each corner of the vault ceiling: 10,000 lb. working tension (40,000 lb. ultimate).
  - 5.5.2 Each corner of the vault floor: 10,000 lb. working tension (40,000 lb. ultimate)
  - 5.5.3 Below the personnel hatch: 10,000 lb. working tension (40,000 lb. ultimate).
  - 5.5.4 On each wall directly opposite a duct bank entry; place a pulling iron. These pulling irons shall be below, but not more than 12 inches below, the duct bank on the opposite wall. See illustration, above.
- 5.6** Pulling irons installed in walls shall have their working tension ratings stamped on the wall near them. Where possible, wall irons shall be rated at or above 10,000 pounds working tension.

## 6. Vault Installation

### 6.1 Vault Type

- 6.1.1 **Footprint:** No network vaults shall be specified smaller than 8 feet wide by 18 feet long (the size of a ring vault). Vaults and other facilities should be built to dimensions large enough to accommodate projected needs and not to the absolute immediate minimum.
- Below grade, cast-in-place, **transformer vaults** shall be 10 feet by 20 feet, minimum.
- 6.1.2 Precast, "Ring," or "Section" vaults shall not be installed in network areas.
- 6.1.3 **Cable Accommodation:** Where transformer vaults are designed with primary cable conduits entering the vault side wall (90° to the length of the vault), add two feet to the width of the vault to allow extra distance between the cable penetration wall and the transformer.
- Where vaults are designed for primary cables of 1,000 kcmil or greater, **no** vault shall be smaller than 10 feet wide by 18 feet long.
- 6.1.4 **Special Height Requirements:** To allow for setting transformers and network protectors, the height of vaults designed for 13 kV transformers shall be a minimum of 9 feet. For 26 kV transformers, the height minimum shall be 10 feet.

## 6.2 Setting Tolerances

- 6.2.1 Precast Panel Vault:
- a. Horizontal alignment: End to end  $\pm 1/8$  in per 1 ft length of vault.
  - b. Vertical alignment: Precast panel vault floor shall be sloped toward the sump when possible. If vault floor cannot be sloped, bedding shall be even and slope toward the sump to insure proper drainage. Vertical slope downward  $1/4 \pm 1/8$  in per 10 ft toward the sump.
- 6.2.2 Cast-In-Place Vault Floor:
- a. Horizontal alignment: End to end  $\pm 1/8$  in per 1 ft length of vault.
  - b. Vertical alignment: Cast in place vault shall be designed and poured with a slope floor towards the sump. Bedding shall be level. Vertical slope tolerance shall be  $3/8$  in per 10 ft length toward the sump.

## 6.3 Vault Parts

- 6.3.1 Do not install parts cracked or otherwise damaged so that watertightness may be impaired.
- 6.3.2 Do not install parts cracked or otherwise damaged so that reinforcing is exposed.

## 6.4 Depth

The dimension from the vault top at the point of least depth to the pavement or ground above shall be as specified by Seattle City Light Work Order and/or construction drawings. Any deviation from this specification shall have the prior approval of the Seattle City Light Engineer.

## 6.5 Seal Mortar

Place approximate 2-inch mortar fillets to seal out water at joints between vault top, cover slab, risers, and frame.

## 6.6 Filling Spaces

Fill spaces through walls, tops, and slabs with dry pack mortar mixed with "Weldcrete" polyvinyl acetate bonding agent in accordance with the manufacturer's directions.

## 6.7 Ladder

Install a permanent ladder in the vault if the distance from the top of the grate to the vault floor exceeds 14 feet 5 inches. See Seattle City Light Drawing D-28304.

## 6.8 Wall Channels

- 6.8.1 Three lengths of galvanized "C" channel shall be embedded flush in each wall.
- 6.8.2 The end of the channel shall be 12 inches from the corner or duct window, whichever is closer.
- 6.8.3 The lowest channel length shall be 18 inches above the vault floor.
- 6.8.4 Channel spacing shall be 28-1/2 inches center-to-center starting from the bottom channel.

## 7. Duct Bank

- 7.1 Engineers shall specify the locations where the duct bank enters the vault on the work order.
- 7.2 Contractors/installers shall verify duct bank location before installation.
- 7.3 Duct bank knockout locations shall be marked by concrete impression on the inside wall for identification.
- 7.4 If possible, windows for duct runs on opposite walls shall be in alignment with each other so cable can be pulled through.
- 7.5 The edge of the ducts shall be from 3 inches (preferred) to no more than 6 inches from corner wall.
- 7.6 Duct runs that come in the same corner on adjacent walls shall be offset vertically so they don't interfere with each other.
- 7.7 Duct termination shall be recessed 6 inches with a 45° angled window edge.

## 8. Sump and Sump Discharge

- 8.1 Size and position the sump as necessary to leave room in the vault corners for pulling irons.
- 8.2 Trench sumps shall be minimum 12 inches deep with flush galvanized cover grate.
- 8.3 Locate sump at same end (below) as personnel hatch.
- 8.4 See NVH-60 for sump pump discharge pipe installation.

## 9. Grounding Electrode System

Install and test grounding electrodes per SCL 0461.10.

## 10. Backfill

Prior to backfilling, install all gaskets at top, bottom, and between walls and grout all seams and wall connections. Grout shall be non-shrink and reach 3000 psi minimum before backfilling.

Backfill with trench-type, controlled-density fill (CDF) that conforms to the City of Seattle Standard Specifications. Place backfill so that no voids are left under the reinforcing ribs or riser sections. The contractor/installer with the assistance of a Licensed Professional Engineer shall consult with the vault manufacturer to assure proper installation of the vault. Backfilling with some specified materials may require a multi-stage compaction processes to avoid damage to vault walls.

## 11. Vault Damage

Structurally damaged vaults shall be replaced or repaired. If the vault is to be repaired then a Washington State licensed professional engineer shall certify that the vault meets the original structural design parameters. For this Guideline, vaults with exposed rebar are considered to be damaged under any circumstances.

## 12. Proximity to Sewers

Vaults set within 5 feet 0 inches of, or over, sewers, will require replacement of the sewer pipe with ductile iron. The new ductile iron pipe must be placed beyond the vault at each end to a minimum of 3 feet 0 inches and/or into undisturbed soil to at least 2 feet 0 inches. Contractor shall do excavation, backfill, and restoration. Installation of the pipe will be made by the Seattle Public Utilities Department.

## 13. References

See Section 1 for code references.

## 14. Sources

**Detter, Chris**; SCL Standards Engineer and subject matter expert for NVH-80

**Ng, Sharon**; SCL Civil Engineer and subject matter expert for NVH-80

**SCL Construction Guideline NCB-20**; "Grounding Network System Transformer Vaults, Wet, Dry, or Spot – Copper Bus"

**SCL Construction Guideline NCB-30**; "Grounding Network System – Wet Vault, Non-Transformer, One or Two 48-Inch Bus Bars"

**SCL Construction Guideline U2-11/NDK-10**; "Installation of Nonmetallic Conduit, Concrete or CDF"

**SCL Construction Guideline U2-12/NVH-60**; "Sump Pump Pipe Installation, Vaults and Manholes"

**SCL Construction Standard 0461.10**; "Grounding Electrodes for Vaults and Handholes"

**SCL Design Standard 9702.30**; "Grounding and Bonding, Fundamentals and Detailed Requirements"

**SCL Material Standard 7150.00**; "Fluidized Thermal Backfill"

**SCL Material Standard 7204.70**; "Frames and Covers, 42-Inch Round, Iron"

## Mandreling and Cleaning of Ducts and Conduits

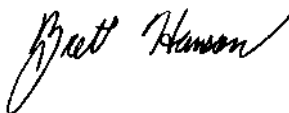
1. After the concrete has been poured or the trench backfilled over conduit, each duct run and conduit shall be tested for obstructions or flattening by pulling a proofing mandrel sized and constructed per Material Standard 7645.40 through the duct or conduit within 5 days of installation. If an obstruction is found in a duct or conduit, that section shall be replaced.
2. Cleaning ducts shall be performed by drawing a brush with stiff bristles and a swab through each duct and conduit to make certain no foreign materials are left in the duct.
3. Conduit runs of 5 inches or larger shall be flushed with a water jet type system such as the "Jet Rodder" equipment. Completion subject to SCL inspector's approval.
4. Cleaning and mandreling operations may be performed simultaneously.
5. After cleaning and mandreling, each conduit shall have left in it a flat, pre-lubricated, polyester or Aramid pull tape of 2,500 lb. minimum tensile strength (Fibertek Inc. or equal; City Light Stock Nos. 012293 and 012480). The pull tape shall be printed with sequential footage markings. 5 feet of slack shall be left in each handhole. 10 feet of slack shall be left in each vault and at each pole riser conduit.
6. After cleaning and mandreling, each conduit shall be plugged with plugs of the type and manufacturer specified in Seattle City Light Material Standard 7055.09.

---

Standard Coordinator  
Brett Hanson

Standards Engineering Supervisor  
John Shipek

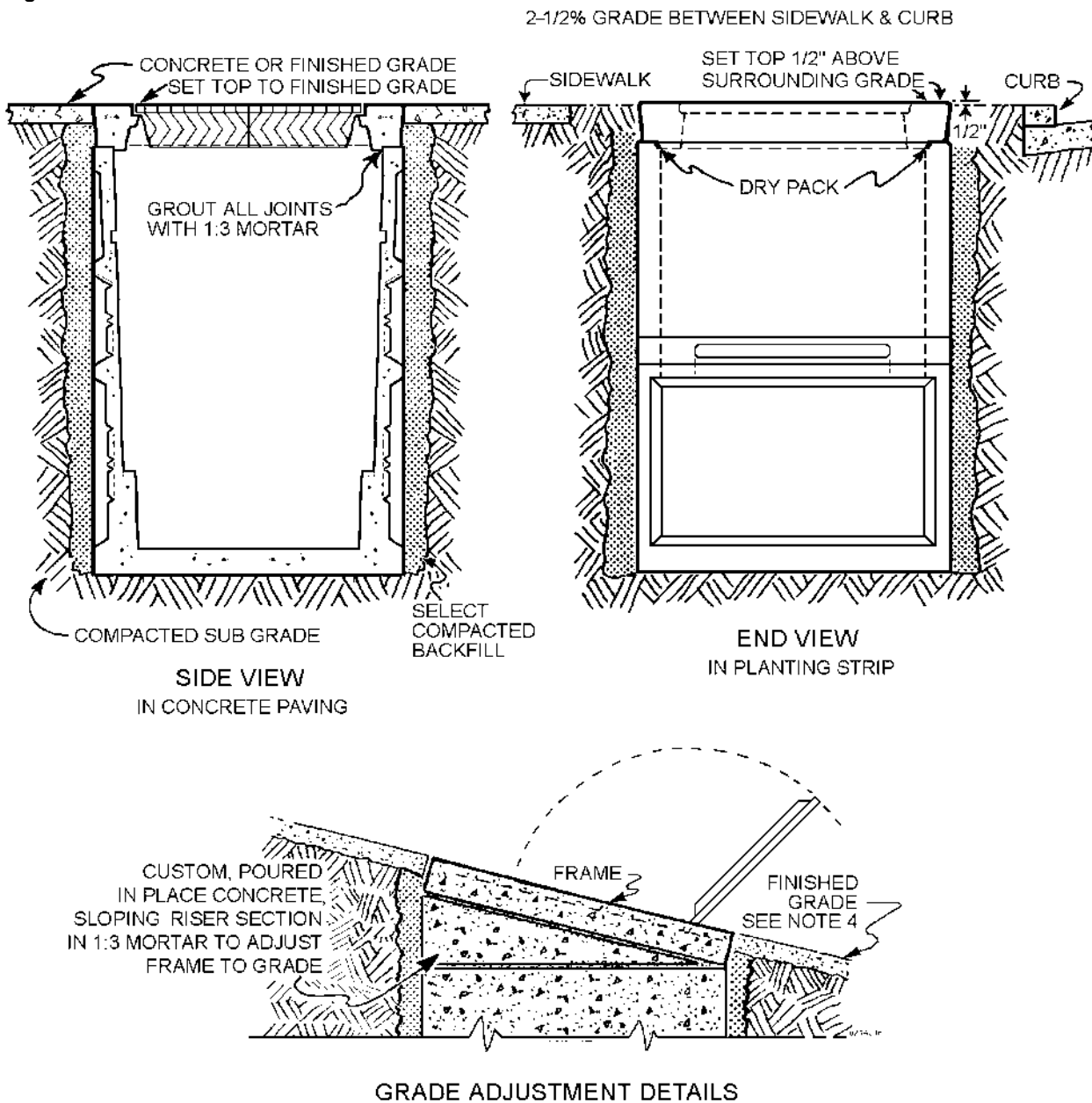
Division Director  
Andrew Strong





### Vault Installation

Figure 1.



Standard Coordinator  
 Brett Hanson

Standards Engineering Supervisor  
 John Shipek

Division Director  
 Andrew Strong

1. **All work, including shoring and bracing**, shall be in compliance with the latest editions of: State of Washington Department of Labor and Industries WAC 296-46B-450 "Equipment for General Use – Transformers and Transformer Vaults," Chapter 296-155- WAC "Safety Standards for Construction Work", Seattle Building Code Section 414 "Transformer Vaults" and Appendix Chapter 4, Division IV, Section 436 "Utility Transformer Vaults", and Seattle Board of Public Works, "Street and Sidewalk Pavement Openings and Restoration Rules".
2. **Concrete** shall be Class 5.5 as specified in "City of Seattle Standard Plans and Specifications". Trowel smooth.
3. **Drypack and seal** all holes tight after installation to prevent water intrusion.
4. When adjusting the **vault entrance** to a sloping grade, install a sloping riser section and a poured-in-place collar. Do not use brick and mortar slope adjustments if possible. Minimize the use of mortar adjustments and in no case shall the mortar thickness exceed one inch. Cast-in-place 42-in round and 54-in by 96-in rectangular risers shall comply with Construction Standard 0231.03. For in-street use, a properly engineered sloping riser section is required. Where the riser section is specified at 12 inches deep or more, order a length of Unistrut cast into the side wall of the riser.
5. On **sloping grade** installations, hinge vault covers as noted. Hinged vault hatches shall be placed so that they lie flat when opened. Load break vaults shall not be installed if the grade exceeds 5.6% in any direction. This is to ensure proper hot stick operations.
6. The **divider**, when used, must come up tight to the vault cover. Brick up as necessary, or if over 4 inches of increase is required, order a special divider.
7. For **transformer and J-Box combinations** in the 577 vault, install rigid steel conduit through the transformer section of the vault as shown on page 1 of U9-5.
8. The preferred **vault orientation** for combination transformer and J-Box in the 577 vault is the length of the vault *perpendicular* to the curb. See SCL 0214.00.
9. The length of the **grated vent slots** must run perpendicular to the dominant direction of travel of sidewalk traffic.
10. **Grounding Electrode System**  
 Install and test grounding electrodes per SCL 0461.10.
11. Engineers shall specify conduit entrance locations into vault on work order. Contractors/installers shall verify before installation.
12. All covers (other than vented grates) shall have a slip resistant surface which has been approved by SCL Standards Engineering.

Hatches and 42-inch round frames in planting strip or sidewalk may be H-20 rated. Hatches where subject to traffic shall have a minimum H-30 rating. 42-inch round frames where subject to traffic shall have a minimum H-25 rating.

### 13. Bedding

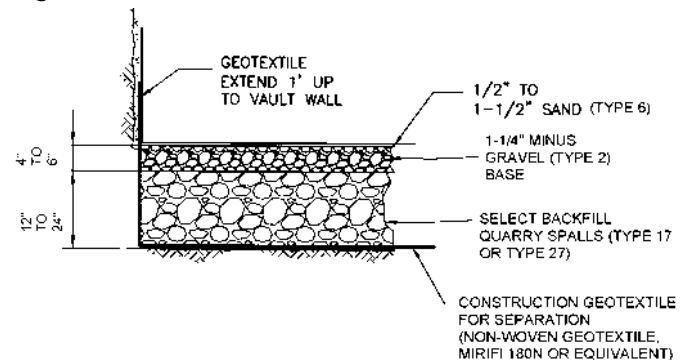
The bedding material shall consist of 4 inches to 12 inches of stable base material, 1-1/4 inch minus gravel (Type 2).

If the excavation bottom is saturated or consists of inadequate bearing material, then over-excavate area as directed by the SCL engineer and place a construction geotextile at the bottom, then 12 to 24 inches of quarry spalls (Select backfill Type 17 or 27). See Figure 13.

If excavation bottom is not saturated and consists of adequate bearing material prior to placing bedding material, compact bottom of excavation with two full compacting operations at right angles to each other with a mechanical compactor.

Place a layer of crushed rock 1-1/4 inch minus gravel (Type 2), screed and compact to a minimum thickness of 4 inches and add 1/2 to 1-1/2 inches of sand (Type 6) to create a level surface.

**Figure 13. Over-Excavation Detail**



### 14. Backfill

Prior to backfilling, install all gaskets at top, bottom, and between walls and grout all seams and wall connections. Grout shall be non-shrink and reach 3000 psi minimum before backfilling.

Backfill with trench-type, controlled-density fill (CDF) that conforms to the City of Seattle Standard Specifications. Place backfill so that no voids are left under the reinforcing ribs or riser sections. The contractor/installer with the assistance of a Licensed Professional Engineer shall consult with the vault manufacturer to assure proper installation of the vault. Backfilling with some specified materials may require a multi-stage compaction processes to avoid damage to vault walls.

### 15. Concrete Collar

See SCL 0223.33.

**16. Sources**

**SCL Construction Standard 0231.03**; "Cast-in-Place Risers"

**SCL Construction Standard 0214.00**; "Clearances between SCL Underground Structures and Other Structures"

**SCL Construction Standard 0461.10**; "Grounding Electrodes for Handholes and Vaults"

**SCL Construction Guideline U9-5**; "577 Vault Transformer and Junction Box Installation, Grounding and Connections"

**SCL Construction Guideline U9-6**; "577 Vault with Three Loadbreak Junction Boxes Installation, Grounding and Connections"

**SCL Design Standard 9702.30**; "Grounding and Bonding, Fundamentals and Detailed Requirements"

**SCL Material Standard 7203.26**; "444 Electric Vault, Primary Service"

**SCL Material Standard 7203.36**; "507 Electric Vault, Primary Service"

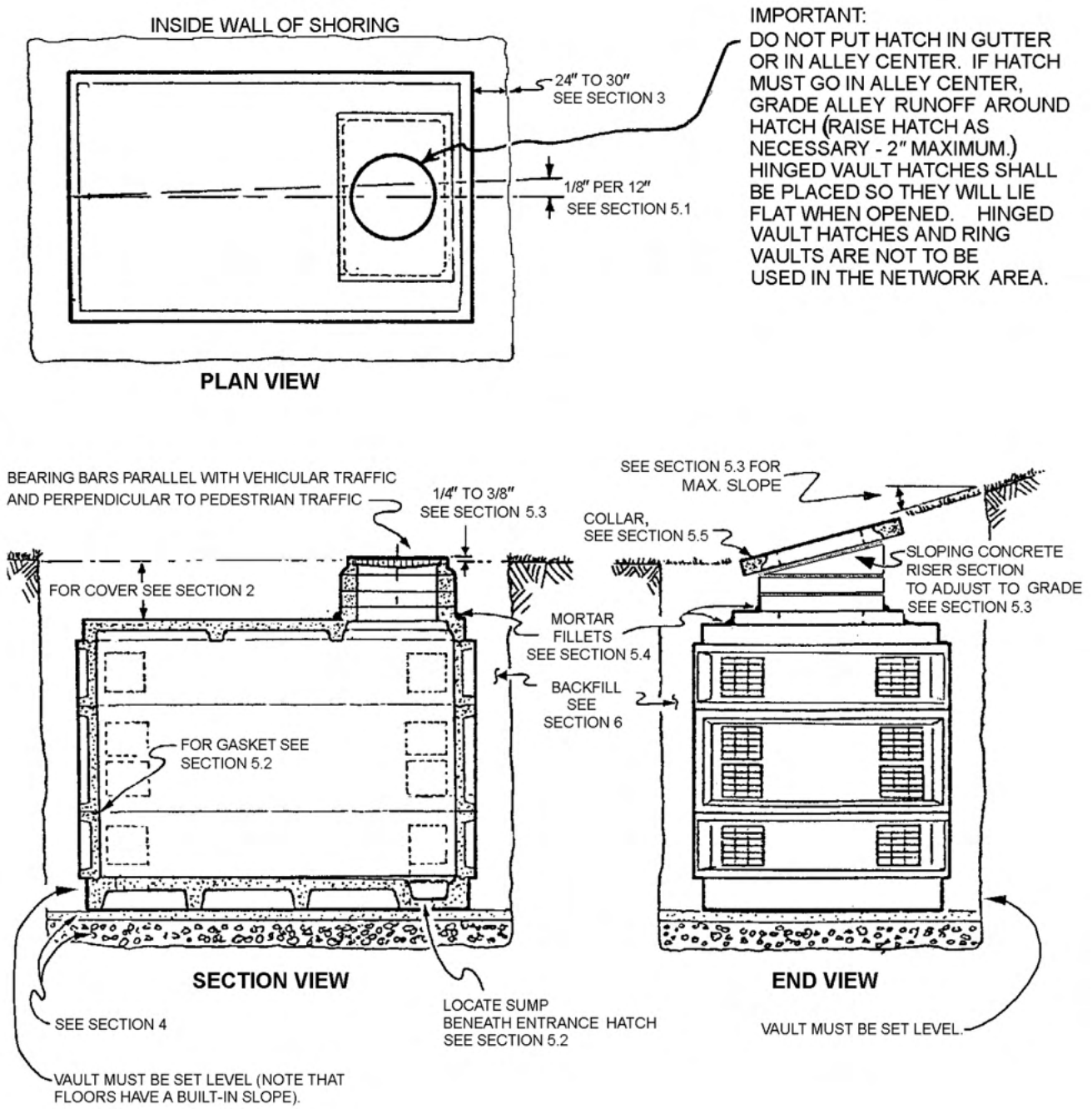
**SCL Material Standard 7203.41**; "577 Electric Vault, Primary Service"

**SCL Material Standard 7204.70**; "Frames and Covers, 42-Inch Round, Iron"

## Installation of Ring Type Vaults

**Figure 1. Typical Vault Installation**

Vault configurations vary. Ring vaults are not acceptable in the Network area.



Standard Coordinator  
Brett Hanson

Standards Engineering Supervisor  
John Shipek

Division Director  
Andrew Strong

## 1. Codes

All work, including shoring and bracing, shall be in compliance with the latest editions of: State of Washington Department of Labor and Industries WAC 296-46B-450 "Equipment for General Use – Transformers and Transformer Vaults," Chapter 296-155 WAC "Safety Standards for Construction Work," Seattle Building Code Section 422 "Private and Utility Transformer Vaults," and the SDOT Director's Rule 2004—02, "Street and Sidewalk Pavement Opening and Restoration Rules."

## 2. Cover

The dimension from the vault top at the point of least depth to the pavement or ground above shall be as specified by Seattle City Light Work Order and/or construction drawings. Any deviation from this specification shall have the prior approval of the Seattle City Light Engineer.

All covers (other than vented grates) shall have a slip-resistant surface which has been approved by City Light Standards.

## 3. Excavation

**3.1** Excavate so there is not less than 24 inches nor more than 30 inches between ends and sides of vault and the vertical sides of excavation or shoring unless larger excavation is authorized by the Engineer.

**3.2** Remove shoring before backfilling.

**3.3** If excavation bottom is saturated prior to placing bedding material, then over-excavate area as directed by the Engineer and place cobbles (3-inch to 8-inch stone – no broken concrete).

## 4. Bedding

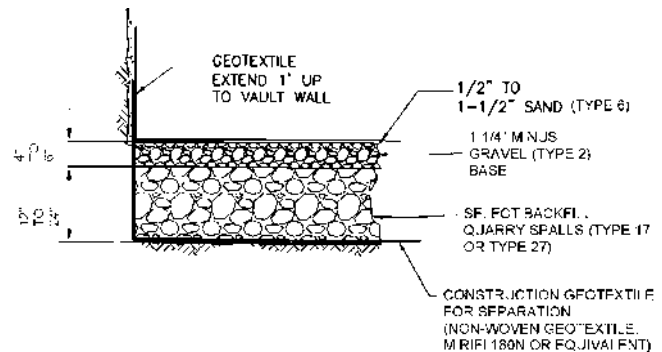
The bedding material shall consist of 4 inches to 12 inches of stable base material, 1-1/4 inch minus gravel (Type 2).

If the excavation bottom is saturated or consists of inadequate bearing material, then over-excavate area as directed by the SCL engineer and place a construction geotextile at the bottom, then 12 to 24 inches of quarry spalls (Select backfill Type 17 or 27). See Figure 4.

If excavation bottom is not saturated and consists of adequate bearing material prior to placing bedding material, compact bottom of excavation with two full compacting operations at right angles to each other with a mechanical compactor.

Place a layer of crushed rock 1-1/4 inch minus gravel (Type 2), screed and compact to a minimum thickness of 4 inches and add 1/2 to 1-1/2 inches of sand (Type 6) to create a level surface.

**Figure 4. Over-Excavation Detail**



## 5. Installation

### 5.1 Setting Tolerances

**5.1.1 Horizontal alignment:** end to end  $\pm 1/8$  in per 1-ft length of vault.

### 5.1.2 Vertical alignment

- Ring Vault 687 and larger with single-piece floor has a built-in sloped floor toward the sump; therefore, the bedding shall be level. Vertical slope tolerance: 3/8 inches per 10-ft length toward the sump.
- Multi piece ring vault floor does not have a built-in sloped floor; therefore, the bedding shall be even and slope toward the sump to ensure proper drainage. Vertical slope tolerance: 1/4 in  $\pm 1/8$  inches in 10 ft toward the sump.

### 5.2 Vault Parts

- a. Do not install parts cracked or otherwise damaged so that watertightness may be impaired, or parts with reinforcing exposed.
- b. If a sump is specified by the SCL engineer, refer to Construction Guideline U2-12.1/NVH-60 for installation. Locate sump at same end as personnel hatch (see below, 5. 3.).
- c. For 814 and 818 vaults, place General Sealant G.S. No. 4 in joints between vault sections. For other vaults, place 5/8-inch by 1-inch butyl rubber "RUBATEX" gasket on the outer ridge of the interlocking joint.

### 5.3 Frame and Cover (Solid or Grate)

- a. Hatches and 42" round frames in planting strip or sidewalk may be H-20 rated.
- b. Hatches, where subject to traffic, shall have a minimum H-30 rating.
- c. 42-inch round frames, where subject to traffic, shall have a minimum H-25 rating.
- d. *In streets, alleys, parking lots, and other vehicle areas*, to match slope of vault entrance with surrounding grade, the acceptable methods are:
  - Precast concrete sloping riser section
  - Cast-in-place concrete sloping riser section

- e. *In sidewalks and other non-vehicle areas, to match slope of vault entrance with surrounding grade, the acceptable methods are:*
  - Brick and mortar if the mortar is less than 1 inch thick
  - Precast concrete sloping riser section
  - Cast-in-place concrete sloping riser section
- f. *Whenever the final grade of the hatch exceeds 10 percent (6 degree slope), the hinge side of the personnel hatch shall be located on the downhill side.*
- g. *Maximum slope of frame and grate shall not exceed 2 inches in 12 inches without permission of SCL engineer. Load break vaults shall not be installed if the grade exceeds 5.6 percent in any direction. This is to insure proper hot stick operation.*
- h. *Where the riser section is specified at 12 inches deep or more, order a length of Unistrut cast into the side wall of the riser.*
- i. *Set riser in 1 inch of mortar (1 part cement to 3 parts sand with polyvinyl acetate bonding agent).*
- j. *Adjust between 1/4-inch and 3/8-inch above grade to prevent water from entering vault, but not to cause a hazard. Ramp concrete to top of frame for gradual transition. Do not put hatch in gutter area. Put hatch 18 inches minimum away from curb line.*

#### 5.4 Seal Mortar

Place 2-inch, plus or minus, mortar fillets to seal out water at joints between vault top, cover slab, risers, and frame.

#### 5.5 Concrete Collar

See SCL 0223.33.

#### 5.6 Filling Spaces

Fill spaces between ground rods and floor slab and other spaces through walls, tops and slabs with dry pack mortar mixed with "Weldcrete" polyvinyl acetate bonding agent in accordance with the manufacturer's directions.

#### 5.7 Ladder

Install a permanent ladder in the vault if the distance from the top of the cover to the vault floor exceeds 12 feet 6 inches. See Seattle City Light Drawing D-28304.

#### 5.8 Conduit Entrances

SCL engineers shall specify the locations where the conduit enters the vault on the work order. Contractors/installers shall verify location before installation.

#### 6. Backfill

Prior to backfilling, install all gaskets at top, bottom, and between walls and grout all seams and wall connections. Grout shall be non-shrink and reach 3000 psi minimum before backfilling. Backfill with trench-type, controlled-density fill (CDF) that conforms to the City of Seattle Standard Specifications. Place backfill so that no voids are left under the reinforcing ribs or riser sections. The contractor/installer with the assistance of a Licensed Professional Engineer shall consult with the vault manufacturer to assure proper installation of the vault. Backfilling with some specified materials may require a multi-stage compaction processes to avoid damage to vault walls.

#### 7. Vault Damage

Structurally damaged vaults shall be replaced or repaired. If the vault is to be repaired, then a Washington State licensed professional engineer shall certify that the vault meets the original structural design parameters. For this Standard, vaults with exposed rebar are considered to be damaged under any circumstances.

#### 8. Grounding Electrode System

Install and test grounding electrodes per SCL 0461.10.

#### 9. Sources

**City of Seattle**; "Standard Specifications for Road, Bridge, and Municipal Construction," 2011

**Hanson, Brett**; SCL Standards Engineer and subject matter expert for U2-15.1

**Ng, Sharon**; SCL Civil Engineer and subject matter expert for U2-15.1

**SCL Construction Guideline NCB-20**; "Grounding Network System Transformer Vaults, Wet, Dry, or Spot - Copper Bus"

**SCL Construction Standard NCB-30**; "Grounding Network System, Wet Vault, Non-Transformer, One or Two 48-Inch Bus Bars"

**SCL Construction Guideline NDK-10**; "Installation of Nonmetallic Conduit with FTB Concrete Encasement"

**SCL Construction Standard U2-11**; "Installation of Nonmetallic Conduit with Concrete, FTB Encasement"

**SCL Construction Guideline U2-12.1/NVH-60**; "Sump Pump Pipe Installation, Vaults and Manholes"

**SCL Construction Guideline U9-7.3**; "Grounding and Connection Diagram, Single Phase 26 kV Distribution Transformer"

**SCL Construction Standard 0461.10**; "Grounding Electrodes for Handholes and Vaults"

**SCL Design Standard 9702.30**; "Grounding and Bonding, Fundamentals and Detailed Requirements"

**SCL Material Standard 7150.00**; "Fluidized Thermal Backfill"

**SCL Material Standard 7203.46**; "712 Electric Vault, Primary Service"

**SCL Material Standard 7203.51**; "814 Electric Vault, Primary Service"

**SCL Material Standard 7204.70**; "Frames and Covers, 42-Inch Round, Iron"

**Precast Panel Vault Installation, General  
 Non-Network Area**



**1. Scope**

This standard covers the installation of panel vaults in the looped radial (non-Network) area. It does not cover ring vault, poured in place, or in-building vault installations. It does not cover panel vault installation in the SCL Network areas.

**2. Application**

A panel vault is used as a structure to pull electric high voltage cable and/ or to house utility electrical equipment below grade.

This standard is intended for use by contractors, SCL civil crews, SCL inspectors, and SCL design engineers for construction, inspection, and design.

**3. Material List**

Item	Component Description	Stock Number	Quantity
1	PANEL VAULT, including gasket and wall connection hardware	special order	1
2	BEDDING, 1-1/4 in crushed rock	special order	as needed
3	CONTROLLED DENSITY FILL, trench backfill per City of Seattle 2005, Standard Specifications for Municipal Construction, Section 9-01.5	special order	as needed
4	GROUT, non-shrink, 3000 psi min	special order	included with vault

Standard Coordinator  
 Brett Hanson

Standards Engineering Supervisor  
 John Shipek

Division Director  
 Andrew Strong



**4. Excavation, Trenching, and Shoring**

- 4.1 Work shall be done per the Washington Administrative Code, Chapter 296-155 Safety Standards for Construction Work.
- 4.2 The depth of the excavation shall allow for the individual components of the vault to be lowered into place.
- 4.3 A minimum clearance of 24 inches to 36 inches around the sidewalls of the vault is required for installation.
- 4.4 The excavation hole must not contain water when setting the vault.
- 4.5 Installations in poor soils may require special dewatering systems to avoid settlement of surrounding areas, including pavement, sidewalks and structures.
- 4.6 Shoring:
  - a. For projects installed by SCL: the Civil Engineering group will provide shoring drawings. If there are no utilities in the excavation area, shoring boxes may be used.
  - b. For projects installed by a contractor: the contractor's licensed civil engineer will provide shoring design.

**5. Bedding**

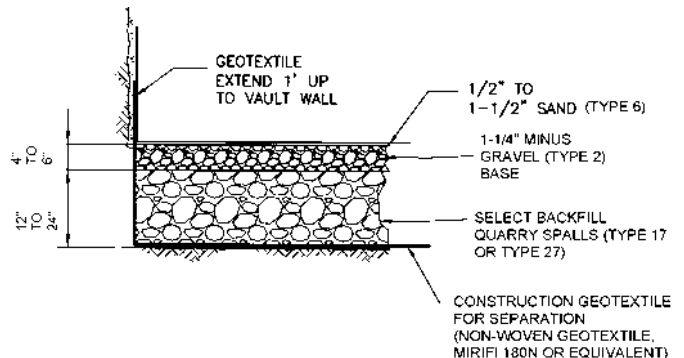
The bedding material shall consist of 4 inches to 12 inches of stable base material, 1-1/4 inch minus gravel (Type 2).

If the excavation bottom is saturated or consists of inadequate bearing material, then over-excavate area as directed by the SCL engineer and place a construction geotextile at the bottom, then 12 to 24 inches of quarry spalls (Select backfill Type 17 or 27). See Figure 5.

If excavation bottom is not saturated and consists of adequate bearing material prior to placing bedding material, compact bottom of excavation with two full compacting operations at right angles to each other with a mechanical compactor.

Place a layer of crushed rock 1-1/4 inch minus gravel (Type 2), screed and compact to a minimum thickness of 4 inches and add 1/2 to 1-1/2 inches of sand (Type 6) to create a level surface.

**Figure 5. Over-Excavation Detail**



**6. Setting**

- 6.1 General: First, the base section is lowered and leveled. Each of the wall sections in lowered and assembled. The seal surfaces between sections must be clean and the gaskets must be in place. The top ring is installed. Finally, the lid is lowered and leveled.
- 6.2 Setting Tolerances:
  - a. Horizontal alignment: end-to-end +/- 1/8" per 1' length of vault.
  - b. Vertical alignment: Confirm if panel vault floor has built-in slope. If floor has built-in slope, bedding shall be even and level. If floor does not have built-in slope, bedding shall be even and slope toward the sump to ensure proper drainage.
  - c. Vertical slope: 1/4" +/- 1/8" in 10' toward the sump.
- 6.3 Install gaskets per manufacturer's instructions.

**7. Knockouts**

- 7.1 Knockouts are provided in each of the four walls.
- 7.2 For conduit entry core drill the knockout area as appropriate. Knockouts should be removed per the SCL project specific drawing.
- 7.3 Knockout penetrations shall be sealed to prevent water intrusion.

**8. Backfilling**

Prior to backfilling, install all gaskets at top, bottom, and between walls and grout all seams and wall connections. Grout shall be non-shrink and reach 3000 psi minimum before backfilling.

Backfill with trench-type, controlled-density fill (CDF) that conforms to the City of Seattle Standard Specifications. Place backfill so that no voids are left under the reinforcing ribs or riser sections. The contractor/installer with the assistance of a Licensed Professional Engineer shall consult with the vault manufacturer to assure proper installation of the vault. Backfilling with some specified materials may require a multi-stage compaction processes to avoid damage to vault walls.

**9. Grouting**

Apply to fill all voids in the joint being sealed to prevent water intrusion.

**10. Top Vault Section, Including Hatches and Doors**

**10.1** Hatches and doors in the top section of the panel vault are project specific, including quantity and location.

**10.2** All covers (other than vented grates) shall have a slip-resistant surface that has been approved by City Light Standards Engineering.

Hatches and 42-inch round frames in planting strip or sidewalk may be H-20 rated.

Hatches, where subject to traffic, shall have a minimum H-30 rating.

42-inch round frames, where subject to traffic, shall have a minimum H-25 rating.

**11. Concrete Collar**

See SCL 0223.33.

**12. Grounding Electrode System**

Install and test grounding electrodes per SCL 0461.10.

**13. Proximity to Other Utility Installations**

Refer to SCL 0214.00 for required clearances to all utility conduits, mains, ducts, pipes and other installations.

**14. References**

**SCL Construction Standard 0214.00**; "Clearances between SCL Underground Structures and Other Structures"

**SCL Construction Standard 0223.33**; "Cast-in-Place Concrete Vault Collars"

**SCL Construction Standard 0461.10**; "Grounding Electrodes for Handholes and Vaults"

**15. Sources**

**"Safety Standards for Construction Work"**; *Washington Administrative Code*, Chapter 296-155, Washington State

**"Controlled Density Fill —Trench Backfill"**; *Standard Specifications for Municipal Construction*; Section 9-01.5, City of Seattle; 2005

**Ng, Sharon**; SCL Engineer and subject matter expert for U2-22 (Sharon.ng@seattle.gov)

**SCL Drawing A-5257**, Rev. 1, dated 11-12-19, "Vault Installation-Overexcavation Detail"

**SCL Material Standard 7204.70**; "Frames and Covers, 42- Inch Round, Iron"

**Siddiqi, Uzma**; SCL Standards Engineer, subject matter expert and originator of U2-22 (uzma.siddiqi@seattle.gov)

**"Vault Installation Instructions"**; Utility Vault; 2006

**WIRE, COPPER, BARE, SOFT-DRAWN**



**1. Scope**

This standard covers the requirements for bare, copper, soft-drawn, stranded wire.

This standard applies to the following Seattle City Light Stock Numbers:

Stock Number	Size, AWG/kcmil	Packaging
610434	#2	reel
610425	2/0	reel
610414	4/0	reel
610412	250	reel
610397	500	reel

**2. Application**

For grounding, jumpers, and other general use.

**3. Industry Standards**

Cable shall meet the applicable requirements of the following industry standards:

**ASTM B3-01** – Standard Specification for Soft or Annealed Copper Wire, 2001

**ASTM B8-04** – Standard Specification for Concentric-Lay-Stranded Copper Conductors, Hard, Medium-Hard, or Soft, 2004

**NEMA WC 26-2000** (EEMAC 201-2000) Binational Wire and Cable Packaging Standard

**4. Construction**

Wire shall meet the requirements of ASTM B8 and **Table A** with the following clarifications:

Conductor alloy shall be soft or annealed, uncoated copper.

**Table A**

Stock Number	Size, AWG/kcmil	Number of Strands	Class
610434	#2	7	B
610425	2/0	7	A
610414	4/0	19	B
610412	250	37	B
610397	500	37	B

**5. Packaging**

**5.1 Quantity**




Actual quantity per reel may vary from the quantity stated on the Purchase Order by plus or minus 10%.

**5.2 Reels**

Reels shall be reusable wood type, Class 1 or 2.

Reels may be new or recycled.

Recycled reels (when provided) shall be have the surface of both outside flanges painted over with a solid color.

standards coordinator	standards supervisor	unit director
 John Shipek	 John Shipek	 Darnell Cola

**MATERIAL STANDARD**

Wire, Copper, Bare, Soft-Drawn

standard number: **6103.90**

superseding: June 11, 2010

effective date: December 8, 2011

page: 2 of 2

**5. Packaging, continued****5.2 Reels, continued**

Recycled reels (when provided) shall be equivalent to new in quality and strength.

Reels shall be protected for shipment with coverings consistent with the recommendations of NEMA WC-26, Section 4.

Reels shall be provided with metal bushings if the gross weight of the reel exceeds 1,000 pounds.

**5.3 Securing of Cable Ends**

The inner end of the cable shall be brought to the outside of the reel flange and securely fastened with appropriately sized steel staples.

The inner end shall not be brought out through the reel arbor.

The outer end shall be securely fastened with appropriately sized steel staples to the inner side of the flange or tied off and secured as with plastic wrap.

**5.4 Marking**

Each reel shall be legibly marked with the following information:

- Manufacturer's identification
- Product description
- Shipping length of cable on reel
- Gross weight
- Tare weight
- Net weight
- Date of manufacture
- Reel identification according to NEMA WC-26, Section 5
- Seattle City Light's Purchase Order Number
- Seattle City Light's Stock Number

**5.5 Detailed Requirements**

Wire shall be packaged on reels according to the requirements of NEMA WC-26 and **Table B**.

**Table B**

Stock Number	Size, AWG/ kcmil	Length per Reel ± 10%, ft	Outside Flange Diameter, Maximum, in	Inside Traverse Width, Maximum, in	Weight per 100 ft., Approx., lbs	Weight per Reel, Approx., lbs
610434	#2	5,280	40	24	021	1,108
610425	2/0	5,280	40	24	041	2,165
610414	4/0	3,450	40	24	65	2,243
610412	250	3,000	40	24	77	2,310
610397	500	1,500	40	24	154	2,310

**6. Shipping**

Reels shall be shipped and delivered in the upright position (on the flange edges) on open flatbed trucks suitable for side unloading by forklift.

Reels shall not be strapped or palleted.

Wire shall be shipped to the address specified on the Purchase Order.

**7. Issuance**

FT

**8. Approved Manufacturers**

Nehring Electrical Works Company  
Service Wire  
Southwire

## Ground Rods, Copper-Covered, Sectional



1. **Ground Rods** shall be fabricated from cold-finished carbon steel shafting in accordance with ASTM Specification A 108, as it applies to Grade 1018.
2. **Construction:** The covering of the steel core shall be a molecularly-bonded sheath of electrolytic-grade copper having a minimum thickness of 0.010". The rods shall have rolled threads at each end for joining together with couplings. The rods shall conform to the applicable requirements of Underwriters' Laboratories UL-467, except as modified herein.
3. **Couplings** for sectional rods shall be made of high-strength, corrosion-resistant bronze, internally threaded to fit standard rods.
4. **Driving Studs** shall be made of high-strength, hardened steel of SAE 1045 or equal quality.
5. **Packaging:** The threaded rod ends shall be protected to prevent thread damage during shipment.
6. **Reference Specifications:**  
 ASTM A 108, SAE 1045, latest revisions  
 NEMA Standard Publication GR 1-2001  
 Underwriters' Laboratories UL-467
7. **Stock Unit:** EA
8. **Approved Manufacturers:**

Stock No.	Description	Hubbell	Eritech	Galvan Industries, Inc.	Southern Grounding Products	Wilcor
564235	5/8-in x 5-ft ground rod	—	635850	6255-10MS	CS 586	WA 585CT
564238	5/8-in x 8-ft ground rod	C635880	635880	6258S	CS 588	WA 588CT
564260	3/4-in x 10-ft ground rod	C633400	633400	7510S	CS 3410	WA 3410CT
564074	5/8-in coupling	CTC58	CR-58	60-C	58C	C 158
564075	3/4-in coupling	CTC34	CR-34	70-C	34C	C 134
564604	5/8-in driving stud	CTDH58	DS58	60-DS	DS 58	D 358
013282	3/4-in driving stud	CTDH34	DS34	70-DS	DS 34	D 334

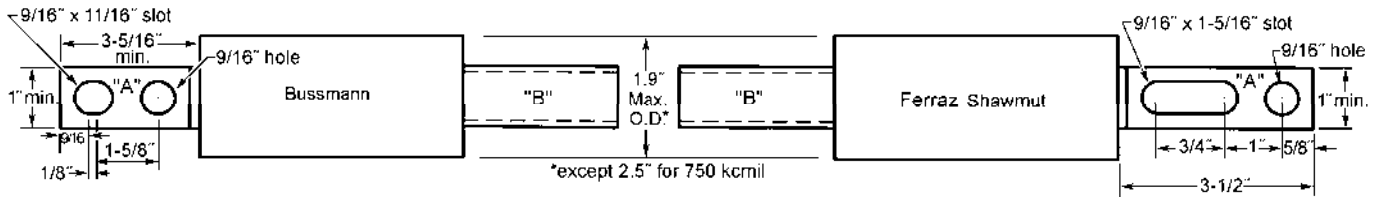
In October 2015, this standard was renumbered from 5642.10 to 6762.25.

Standards Coordinator  
 Laura Vanderpool

Standards Supervisor  
 John Shipek

Unit Director  
 Darnell Cola

**LIMITER – 600 VOLT, COPPER CABLE TO BUS BAR**



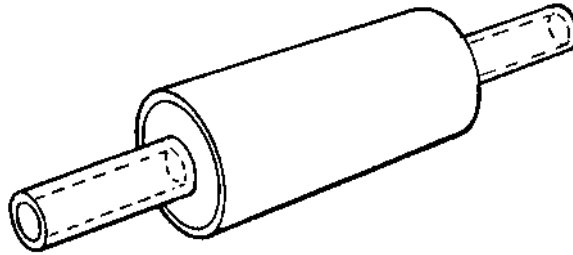
1. **Cable Limiters** of the configuration shown are intended to protect copper cables on 277/480, 120/208, or 120/240 volt, 1-phase or 3-phase, underground or overhead, distribution or network systems.
2. **Interrupting Duty:** The cable limiter shall have an AC interrupting duty of 200,000 amperes rms symmetrical at 600 volts or less, and shall clear faults within its duty range without any visible external physical damage to the cable or limiter. No ionized gases or volatilized metal shall be emitted.
3. **Terminals:** Terminal "A" shall be plated copper bar of size and drilling meeting all applicable requirements of NEMA CC 1 (ANSI C 119.3).  
Terminal "B" shall be plated copper meeting all applicable requirements of NEMA SG 8.1. Terminal "B" shall meet the tool and die requirements listed below, and shall have durable markings showing the conductor size, either on the terminal or on the limiter body.
4. **Insulating Sleeves:** Not desired.
5. **Reference Specifications:**  
**NEMA CC 1**, *Electric Power Connectors for Substations*; ANSI C 119.3; latest revisions  
**NEMA SG 8.1**, *Pressure Connectors for Copper Conductor*; 8/59
6. **Stock Unit:** EA

Stock Numbers	Cable Size	Limiters					
		Approved Manufacturers		Terminal Tool and Die Requirements			
		Cooper/ Bussmann	Mersen	EI Die Index	Burndy	Cooper/ Kearney	T&B
683621	#4	KDY	–	8	242, U4CRT	5/16	29
683622	#2	KDA	CP2C3	10	162, U2CRT	3/8	33
683623	2/0 AWG	KDD	CP2/0C3	13	241, U26RT	9/16	45
683624	3/0 AWG	KDE	–	14	243, U27RT	9/16	50
683625	4/0 AWG	KDF	CP4/0C3	15	U28RT	5/8	54
683626	250 kcmil	KDH	CP250C3	16	166, U29RT	11/16	62
683627	350 kcmil	KDJ	CP350C3	18	168, U31RT	840	71
683629	500 kcmil	KDM	CP500C3	20	251, U34RT	1	87
011158	600 kcmil	KDU	CP600C3	–	U36RT, P36RT	–	–
683630	750 kcmil	KDR-S	CP750C3	24	209, S39RT	H25	106

<i>standards coordinator</i>	<i>standards manager</i>	<i>unit director</i>
 John Shipek	 John Shipek	 Pamela S. Johnson

**MATERIAL STANDARD**

**LIMITER - 600 VOLT - COPPER CABLE TO COPPER CABLE**



1. **Application:** Cable Limiters of the configuration shown are intended protect copper cables on 277/480, 120/208, or 120/240 volt, 1-phase or 3-phase, underground or overhead, distribution or network systems.
2. **Interrupting Duty:** The cable limiter shall have an AC interrupting duty of 200,000 amperes rms symmetrical at 600 volts or less, and shall clear faults within its duty range without any visible external physical damage to the cable or limiter. No ionized gases or volatilized metal shall be emitted.
3. **Terminals:** Both terminals shall be plated copper. The terminals shall have durable markings showing the conductor size, either on the terminals or on the limiter body.
4. **Stock Unit:** EA

Stock Numbers	Cable Size	Approved Manufacturers	
		Cooper/ Bussmann	Mersen
683641	#4	KCY	–
683643	#2	KCA	CP2C1
683646	2/0 AWG	KCD	CP2/0C1
683647	3/0 AWG	KCE	–
683648	4/0 AWG	KCF	CP4/0C1
683649	250 kcmil	KCH	CP250C1
683650	350 kcmil	KCJ	CP350C1
683651	500 kcmil	KCM	CP500C1
683652	750 kcmil	KCR	CP750C1

standards coordinator

John Shipek

standards supervisor

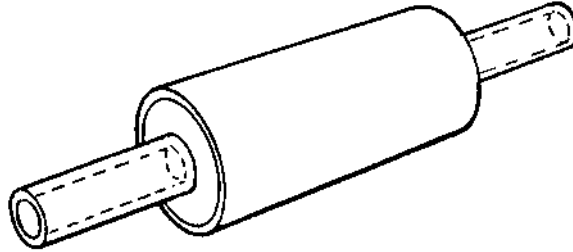
John Shipek

unit director

Darnell Cola

**MATERIAL STANDARD**

**LIMITER - 600 VOLT - ALUMINUM CABLE TO ALUMINUM CABLE**



1. **Application:** Cable Limiters of the configuration shown are intended protect aluminum cables on 277/480, 120/208, or 120/240 volt, 1-phase or 3-phase, underground or overhead, distribution or network systems.
2. **Interrupting Duty:** The cable limiter shall have an AC interrupting duty of 200,000 amperes rms symmetrical at 600 volts or less, and shall clear faults within its duty range without any visible external physical damage to the cable or limiter. No ionized gases or volatilized metal shall be emitted.
3. **Terminals:** Both terminals shall be aluminum. Both terminals shall be factory-filled with a measured amount of oxide-inhibiting compound. Both terminals shall have durable markings showing the conductor size, either on the terminals or on the limiter body.
4. **Stock Unit:** EA

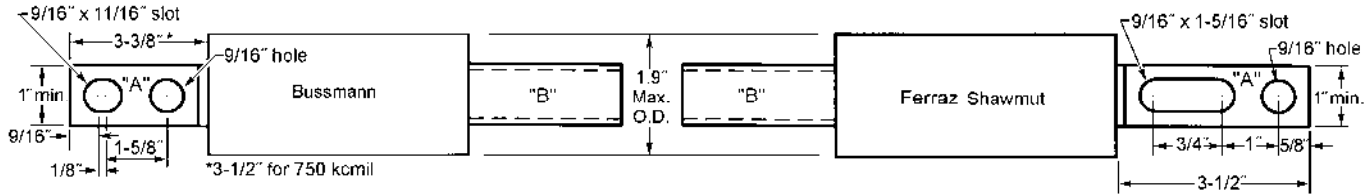
Stock Numbers	Cable Size	Approved Manufacturers	
		Cooper/ Bussmann	Mersen
683615	4/0 AWG	–	CP4/0A1
683616	250 kcmil	–	CP350A1
683617	350 kcmil	CDA-R	CP500A1
683618	750 kcmil	CDA-W	CP750A1

<i>standards coordinator</i>	<i>standards manager</i>	<i>unit director</i>
 John Shipek	 John Shipek	 Pamela S. Johnson



**MATERIAL STANDARD**

**LIMITER – 600 VOLT, ALUMINUM CABLE TO BUS BAR**



1. **Cable Limiters** of the configuration shown are intended protect aluminum cables on 277/480, 120/208, or 120/240 volt, 1-phase or 3-phase, underground or overhead, distribution or network systems.
2. **Cable Class:** The cable limiters shall coordinate with the insulation damage curves of L-260 (See AIEE Paper 59-27.).
3. **Interrupting Duty:** The cable limiter shall have an AC interrupting duty of 200,000 amperes rms symmetrical at 600 volts or less, and shall clear faults within its duty range without any visible external physical damage to the cable or limiter. No ionized gases or volatilized metal shall be emitted.
4. **Terminals:** Terminal "A" shall be plated copper bar of size and drilling meeting all applicable requirements of NEMA CC 1.  
 Terminal "B" shall be aluminum meeting all applicable requirements of NEMA CC 3. Terminal "B" shall be factory-filled with a measured amount of oxide-inhibiting compound that will not affect the dielectric strength or power factor of cables insulated with butyl, polyvinyl chloride, polyethylene, or cross-linked polyethylene. Terminal "B" shall meet the tool and die requirements listed below, and shall have durable body markings showing the conductor size, either on the terminal or on the limiter body.
5. **Insulating Sleeves:** Not desired.
6. **Reference Specifications:**  
 AIEE Paper 59-27, June 1959, No. 42, pages 129-416, *Power Apparatus and Systems*.  
 NEMA Standard CC 1, Electrical Power Connection for Power Stations, latest revision.  
 NEMA Standard CC 3 (EEI TDJ-162), Connectors for Use Between Aluminum or Aluminum-Copper Overhead Conductors, latest revision.
7. **Stock Unit:** EA

**Limiters**

Stock Numbers	Cable Size	Approved Manufacturers		Terminal Tool and Die Requirements			
		Bussmann	Mersen	Die Index	Burndy	Kearney	T&B
683637	4/0 AWG	–	CP4/0A3	11A	298, U28AR	840	76
683638	350 kcmil	–	CP350A3	13A	299, U31AR	1-1/8	96
683639	500 kcmil	CDB-R	CP500A3	15A	300, U34AR	1-5/16	115
683659	750 kcmil	CDB-W	CP750A3-SP2*	–	301, P39AR	1-1/2	125

\* SP2 = Special Production 2.

<i>standards coordinator</i>  John Shipek	<i>standards manager</i>  John Shipek	<i>unit director</i>  Pamela S. Johnson
--	--	--

## Tape, Detectable, Underground, Marking



### 1. Scope

This standard covers the requirements for detectable, underground marking tape. Marking tape is also known as detectable tape. This standard applies to Seattle City Light (SCL) Stock No. 736800.

### 2. Application

Marking tape is used for detecting, locating, identifying, and protecting buried electric lines installed in trenches or conduits. Marking tape has a solid core, which provides for detectability with either inductive or conductive modes using a pipe and cable locator. Recommended burial depth for detection is 9-12 inches.

### 3. Industry Standards

Marking tape shall meet the applicable requirements of the latest revision of the following industry standards:

**ASTM D2103**; Standard Specification for Polyethylene Films and Sheeting

**ASTM D882**; Standard Test Method for Tensile Properties and Elongation of Thin Plastic Sheeting

**ASTM D2578**; Standard Test Method for Wetting Tension of Polyethylene and Polypropylene Films

**ASTM D792**; Standard Test Methods for Density of Plastics by Displacement

**ASTM D671**; Standard Test Method for Flexural Fatigue of Plastics

### 4. Requirements

Marking tape shall be designed with an aluminum core so that it can be detected using standard inductive locating equipment.

Print ink shall be permanent and resistant to removal by normal handling or burial.

Tape and ink shall be chemically inert and not degrade when exposed to acids, alkalis, and other destructive substances commonly found in soil.

Standards Coordinator  
Muneer Shetab

Standards Supervisor  
John Shipek

Unit Director  
Andrew Strong

Text shall be reverse printed.

Additional requirements shall be as cited in Table 4.

**Table 4. Marking Tape Requirements**

<b>Text</b>	CAUTION ELECTRIC LINE BURIED BELOW or CAUTION BURIED ELECTRIC LINE BELOW
<b>Text color</b>	Black
<b>Background</b>	Solid red or diagonal striped red on white background
<b>Overall thickness, range, nominal</b>	5 to 6 mil
<b>Width, nominal</b>	3 in
<b>Length per roll</b>	1000 ft

---

## 5. Packaging

Marking tape shall be packaged to prevent damage during shipping, handling, and storage.

Marking tape shall be supplied on rolls.

Each standard package shall be legibly marked with the following information:

- Manufacturer identification
- Product description
- SCL stock number
- Quantity

Each shipping container shall be legibly marked with the following information:

- SCL purchase order number
- 

## 6. Issuance

Stock Unit: RL

---

## 7. Approved Manufacturers

<b>Manufacturer</b>	<b>Catalog No.</b>	<b>Background Style</b>
Reef Industries Inc.	42-0110	Solid red
Pro-Line Safety Products	103126053	Diagonal striped red on white background

---

## 8. Sources

[prolinesafety.com](http://prolinesafety.com)

[reefindustries.com](http://reefindustries.com)

**Shetab, Muneer**; SCL Standards Engineer, originator, and subject matter expert for 7005.05

**Stock Catalog Page 70-51**; April 27, 2018

**Stock Catalog Page 73-40**; January 11, 2014

## Schedule 40 PVC Conduit and Fittings



### 1. Scope

This standard covers the requirements for Schedule 40 extruded rigid polyvinyl chloride (PVC) conduit and fittings consisting of elbows, couplings, and adapters.

### 2. Application

Schedule 40 PVC conduit and fittings are used to construct smooth raceways for the pulling in of cable installed in a variety of Looped Radial and Network system applications:

- Service
- Secondary
- Primary
- Communication
- Control

See SCL 0222.02.

Five-inch (IPS) size conduit may have both straight ends or a standard bell end and straight end.

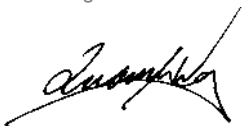
Elbows are also known as bends. Large-radius elbows are also known as sweeps.

The straight-cut end of a section of conduit or elbow is also known as the spigot end.

Standards Coordinator  
Quan Wang

Standards Supervisor  
John Shipek

Unit Director  
Andrew Strong



### 3. Industry Standards

Schedule 40 PVC conduit and fittings shall meet the applicable requirements of the latest revision of the following industry standard:

**UL 651** - Standard for Schedule 40 and 80 Rigid PVC Conduit and Fittings, 7th Edition, dated October 4, 2005

The following clarifications apply:

- Five-inch (IPS) size shall meet the requirements for specific applications, Section 4.5 (straight cut, without couplings or adapters).
- All other (IPS) sizes shall meet the requirements for general use, Section 4.6 (one bell end).

### 4. Detailed Requirements

#### 4.1 General

Conduit and fittings shall be suitable for above ground use indoors or outdoors exposed to sunlight and weather, and for underground use by direct burial or encasement in concrete.

Conduit and fitting dimensions shall conform to UL 651 and the Iron Pipe Standard (IPS), where dimensions are based on outside diameters of iron pipe sizes.

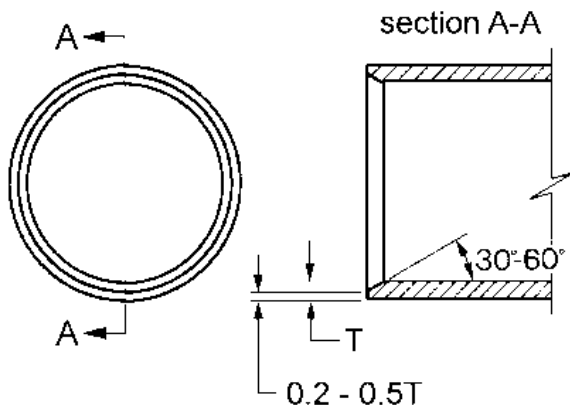
Conduit and fitting color shall be medium to dark gray.

Conduit and fittings shall not have any features that can abrade or otherwise damage cable.

All straight-cut ends from conduit, reducers, and elbows with a diameter of 2 in (IPS) and larger shall be chamfered according to Figure 4.1.

Conduit, elbows, and fittings shall be designed and manufactured to be a system intended to guarantee complete interchangeability and compatibility between components.

**Figure 4.1. Chamfer Detail**



## 4.2 Conduit

Conduit shall be certified by Underwriters Laboratories (UL) or one of the following NRTLs (Nationally Recognized Testing Laboratories) as meeting the minimum requirements of Standard UL 651:

- CSA (Canadian Standards Association)
- ETL
- NSF International

Manufacturer shall inform SCL in writing of all design changes that could affect the product's understood or published capabilities or attributes.

Dimensional information cited in Sections 4.2, 4.3, and 4.4 should be consistent with UL requirements and is provided for the convenience of SCL design engineers, construction crews, inspectors, and quality assurance personnel who do not have ready access to UL 651.

Conduit shall meet the performance requirements as described in Table 4.2a.

**Table 4.2a. Conduit performance requirements**

Description	UL 651 Section
Tensile strength	7
Deflection under heat and load	8
Extrusion process	9
Low-temperature handling	10
Water absorption	11
Resistance to crushing	12
Resistance to impact	13
Flame	14
Conduit for use with 90 degree C wire	17
Resistance to specific reagents	18
Sunlight resistance	19
Pipe stiffness	20
Pull-joint separation	21
Bending and pull-joint separation	22
Joint water tightness	23
Elastomeric materials accelerated aging	24
Permanency of printing	25

**Table 4.2b. Conduit Dimensions, Straight (str)**

Stock No.	Trade Size, IPS (in)	End #1	End #2	Outside Diameter, Min (in)	Outside Diameter, Average, (in)	Outside Diameter, Max (in)	Inside Diameter, Min, Average (in)	Wall Thickness, Min (in)	Weight, Nominal, (lb / ft)
734525	1/2	Bell	Str cut	0.832	0.840	0.848	0.578	0.109	0.16
734526	3/4	"	"	1.040	1.050	1.060	0.780	0.113	0.22
734527	1	"	"	1.305	1.315	1.325	1.004	0.133	0.32
734528	1-1/4	"	"	1.648	1.660	1.672	1.335	0.140	0.43
734529	1-1/2	"	"	1.888	1.900	1.912	1.564	0.145	0.52
734530	2	"	"	2.363	2.375	2.387	2.021	0.154	0.70
734531	2-1/2	"	"	2.860	2.875	2.890	2.414	0.203	1.11
734532	3	"	"	3.485	3.500	3.515	3.008	0.216	1.45
734533	3-1/2	"	"	3.950	4.000	4.050	3.486	0.226	1.74
734523	4	"	"	4.450	4.500	4.550	3.961	0.237	2.10
734524	5	Str cut	"	5.513	5.563	5.613	4.975	0.258	2.80
"	5	Bell	Str cut	5.513	5.563	5.613	4.975	0.258	2.80



**4.3 Elbows**

**Table 4.3a. Elbow Dimensions, 90 and 45 Degree**

Stock No.	Trade Size, IPS (in)	Degree Bend	End #1	End #2	Radius (in)
734551	1/2	90	Bell	Str. cut	4
734671	3/4	90	"	"	4-1/2
734550	1	90	"	"	5-3/4
734546	1-1/4	90	"	"	7-1/4
734547	1-1/2	90	"	"	8-1/4
734548	2	90	"	"	24
734549	2-1/2	90	"	"	24
014572	3	90	"	"	24
014573	4	90	"	"	24
734553	1-1/4	45	"	"	7-1/4
734554	1-1/2	45	"	"	8-1/4
734555	2	45	"	"	18
014574	3	45	"	"	24
014575	4	45	"	"	24
734557	3	45	"	"	36
734559	4	45	"	"	36



90-degree elbow



45-degree elbow

**Table 4.3b. Elbow Dimensions, 22-1/2 and 5 Degree**

Stock No.	Trade Size, IPS (in)	Degree Bend	End #1	End #2	Radius (in)
734561	2	22-1/2	Bell	Str. cut	18
734562	2-1/2	22-1/2	"	"	18
734563	3	22-1/2	"	"	24
734566	4	22-1/2	"	"	24



22-1/2 degree elbow

#### 4.4 Fittings

Female adapters shall have straight threads. Coupling fittings, 2 inch (IPS) and larger, shall be of molded manufacture, not expanded.

**Table 4.4a. Fittings, Female (F), Male (M), and Slip (S)**

Stock No.	Trade Size, IPS (in)	Description	Ends
734508	1/2	Female adapter	S x F
734540	3/4	"	"
734541	1	"	"
734542	1-1/4	"	"
734543	1-1/2	"	"
734544	2	"	"
734545	2-1/2	"	"
734537	3	"	"
734539	4	"	"
734536	5	"	"
734920	1/2	Male adapter	S x M
734914	3/4	"	"
734918	1	"	"
734924	1-1/4	"	"
734925	1-1/2	"	"
734926	2	"	"
734921	3	"	"
734923	4	"	"



female adapter

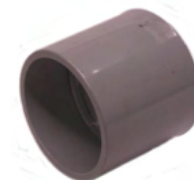


male adapter

Coupling fittings, 2 inches (IPS) and larger, shall be of molded manufacture, not expanded.

**Table 4.4b. Fittings, Straight Couplings, Slip (S)**

Stock No.	Trade Size, IPS (in)	Description	Ends
734512	1/2	Straight coupling	S x S
734513	3/4	"	"
734514	1	"	"
734515	1-1/4	"	"
734516	1-1/2	"	"
734517	2	"	"
734518	2-1/2	"	"
734519	3	"	"
734521	4	"	"
734522	5	"	"



straight coupling



**Table 4.4c. Fitting, Swedge Reducer**

Stock No.	End #1	End #2	Description	End #1	End #2
	Trade Size, IPS (in)	Trade Size, IPS (in)		End #1	End #2
734470	3	2-1/2	Reducer	Chamfered Str. Cut	Chamfered Str. Cut
012503	4	3-1/2	Reducer	Chamfered Str. Cut	Chamfered Str. Cut



Long sleeve repair couplings shall have no center stop.

Long sleeve repair couplings shall have a minimum length of 10 in.

**Table 4.4d. Fittings, Long Sleeve Couplings without Center Stop, Slip (S)**

Stock No.	Trade Size, IPS (in)	Description	Ends
	013705		
013706	3	"	"
013707	4	"	"
013708	5	"	"

Long sleeve swedged couplings shall have a minimum length of 8.25 in.

Long sleeve swedged couplings shall have minimum bell depth of 3.25 in at each end.

**Table 4.4e. Fittings, Long Sleeve Couplings, Swedged, Slip (S)**

Stock No.	Trade Size, IPS (in)	Description	Ends
	014576		
014577	5	Long sleeve swedged coupling	"



**Table 4.4f. Reducer Bushing (Slip)**

Stock No.	Trade Size, IPS (in)	Description	Ends
	734480		



Reducer bushings shall fit into the bell end of the conduit.

## 5. Marking

Each conduit section shall be marked according to the requirements of UL 651, Section 25.

The outer surface of each conduit section shall be marked with the following minimum information:

- Trade size
- Schedule number or equivalent information
- Manufacturer's name or symbol
- Date (or period) of manufacture
- UL or NRTL mark

Each fitting shall be marked according to the requirements of UL 651, Section 46.

The outer surface of each fitting shall be marked with the following minimum information:

- Manufacturer name or symbol
  - Catalog number
- 

## 6. Testing

Conduit and fitting test data that establishes compliance with the requirements of UL 651 and this material standard shall be provided upon request.

---

## 7. Packaging

Fittings shall be packaged to prevent damage during shipping, handling, and storage.

Straight conduit shall be furnished in 10-ft sections unless specified otherwise on the purchase order.

Master bundles shall be secured with at least two bands of steel or UV-resistant plastic strapping.

Each master bundle of straight conduit shall be legibly marked with the following information:

- Manufacturer identification
  - Product description
  - Seattle City Light purchase order number
  - Seattle City Light stock number
  - Gross, net, and tare weight
- 

## 8. Shipping

Conduit may be delivered on enclosed, covered, or flatbed trucks. If conduit is delivered on a flatbed truck, conduit shall be side-loaded.

Because Washington State law requires a 10-in minimum side board when driving a forklift or pallet jack onto the bed of a truck or trailer, most flatbed trucks or trailers must be side-loaded to ease off-loading.

---

## 9. Issuance

Conduit: FT

Elbows: EA

All Other Fittings: EA

## 10. Approved Manufacturers

### 10.1 Products Approved for Purchase by SCL

#### Conduit Straight Sections

- Cantex (Mitsubishi Corp.)
- Cresline NW
- Heritage Plastics Inc. (Atkore Int'l)
- IPEX
- JM Eagle
- Prime Conduit (formerly Carlon; Mitsubishi Corp.)
- Ridgeline Pipe Mfg. (Atkore Int'l)
- Royal Pipe Systems

#### Elbows

- Cantex (Mitsubishi Corp.)
- Heritage Plastics Inc. (Atkore Int'l)
- Scepter (IPEX)
- JM Eagle
- Kraloy (IPEX)
- Raceways Technology & Mfg.
- Ridgeline Pipe Mfg. (Atkore Int'l)
- Carlon (Thomas & Betts)
- Royal Pipe Systems

#### All Other Fittings

- Cantex (Mitsubishi Corp.)
- Heritage Plastics Inc. (Atkore Int'l)
- Scepter (IPEX)
- JM Eagle
- Kraloy (IPEX)
- Ridgeline Pipe Mfg. (Atkore Int'l)
- Carlon (Thomas & Betts)
- Royal Pipe Systems

### 10.2 Products Approved for Purchase and Installation by SCL Contractors

SCL contractors may purchase and install cellular core PVC conduit straight sections from Rocky Mountain Colby Company.

SCL contractors may purchase and install solid PVC conduits, elbows, and fittings from the approved manufacturers cited in section 10.1.

SCL contractors may purchase and install 5-in conduit with belled end and spigot end from approved manufacturers cited in Section 10.1, "Conduit Straight Sections."

---

## 11. References

**SCL Construction Standard 0222.02**; "Requirements for Duct Banks in the Public Right-of-Way"

**SCL Material Standard 7345.2**; "Conduit and Fittings, EPC 40 and EPC 80 Rigid Polyvinyl Chloride" (canceled)

## 12. Sources

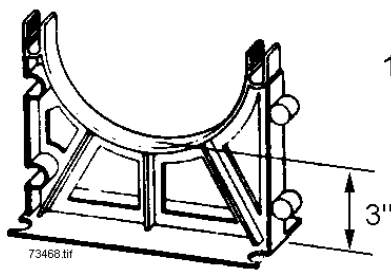
**ASTM F 512**; “Standard Specification for Smooth-Wall Poly Vinyl Chloride (PVC) Conduit and Fittings for Underground Installation”

**ASTM F891**; “Standard Specification for Coextruded Poly Vinyl Chloride (PVC) Plastic Pipe With a Cellular Core”

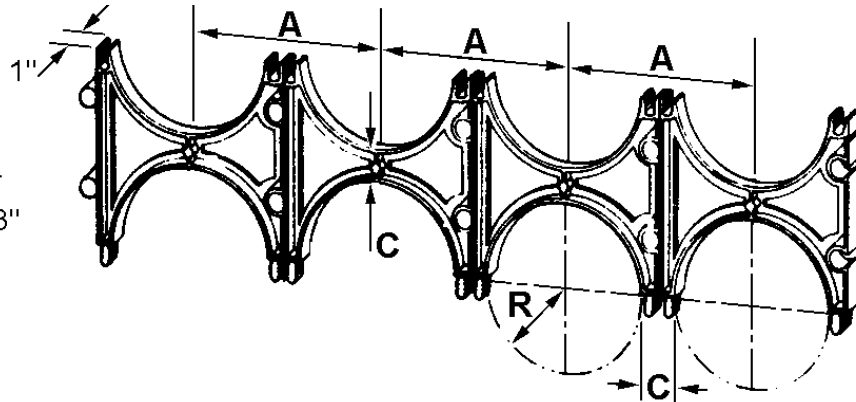
**Shipek, John**; SCL Standards Supervisor, subject matter expert, and originator of 7015.05

**Wang, Quan**; SCL Standards Engineer and subject matter expert for 7015.05

## Conduit Spacers for PVC and FG Conduit



**Base Spacer**  
**Figure 1**



**Intermediate Spacer**  
**Figure 2**

**Plastic Spacers for Nonmetallic Conduit** shall be of the general configuration shown, and shall be molded from a general-purpose polystyrene meeting the requirements of ASTM Standard D4549 for Type 1 molding material.

Each unit shall have two lugs for interlocking on one side and bottom, and two mating holes on the other side and top. The lugs shall fit corresponding holes snugly, permitting rapid, secure field assembly of multiple units. Separation between conduits shall be 2 inches for all sizes of spacers.

**Reference Specification:** ASTM D4549, latest revision.

**Stock Unit:** EA

Stock Number	Figure Number	Nominal Conduit Size	Dimensions in Inches			Approved Manufacturers		
			A	C	R	CalAm	*GS Industries	Kraloy/lpex
intermediate	734669	3	5.6	2.0	1.8	4130-20	158-1	IV-3020
	734670	4	6.6	2.0	2.3	4140-20	124-1	IV-4020
	734680	5	7.9	2.0	2.9	4150-20	130-1	IV-5020
	010447	6	8.7	2.0	3.4	4160-20	134-1	IV-6020
base	010448	3	5.6	2.0	1.8	4030-20	159-1	BV-3020
	734690	4	6.6	2.0	2.3	4040-20	125-1	BV-4020
	734692	5	7.9	2.0	2.9	4050-20	131-1	BV-5020
	010446	6	8.7	2.0	3.4	4060-20	135-1	BV-6020

\* GS Industries of Bassett, Inc. GS Industries spacers marked "Underground Products" are acceptable.

These items are approved for contractor use but NOT for City Light stock.

Approved Manufacturers:

- Underground Device Inc. Wunpeece Duc Spacer SERIES
- Cantex 53360xx and 53359xx SERIES
- PWPipe 6268 and 6266 SERIES

In October 2015, this standard was renumbered from 7346.8 to 7015.80.

**Zinc-Coated Steel Conduit and Fittings****1. Scope**

This standard covers the requirements for zinc-coated steel conduit and fittings consisting of elbows, couplings, and nipple stock.

**2. Application**

Zinc-coated steel conduit and fittings are used to construct smooth raceways for the pulling in of cable.

Design engineers should be aware that different types of conduit have widely different physical properties that affect their application. Less expensive Schedule 40 PVC, Schedule 80 PVC, and/or fiberglass conduit systems should be considered first.

Refer to Design Standard 9220.05 for more information matching conduit with cable and application.

For new construction, design engineers are directed to utilize the following standard conduit trade sizes:

- 1/2
- 1-1/2
- 2
- 3
- 4
- 5

Design engineers should move away from utilizing these trade sizes (IPS):

- 3/4
- 1
- 2-1/2
- 3-1/2

Steel conduit is also known as electrical rigid metal conduit - steel, abbreviated ERMCS. Conduit that is finished means it has a threaded coupling attached to one end.

Elbows are also known as bends. Large radius elbows are also known as sweeps or large sweeps. Five-inch trade size, 60-inch radius sweeps, Stock Number 734826, are used at the base of a riser pole.

Underground duct systems typically utilize elbows that are bent in the field from straight sections. Field bending elbows allows for custom angles and better nesting of multiple runs.

UL 6 defines a nipple to be a straight section of conduit 24 inches in length or less, with male pipe threads at each end. Technically, Seattle City Light purchases nipple *stock*, also known as running thread.

**3. Industry Standards**

Zinc-coated steel conduit and fittings shall meet the requirements of the following industry standard:

**UL 6** - Standard for Electrical Rigid Metal Conduit - Steel, 14th Edition, dated November 30, 2007

**4. Detailed Requirements****4.1 General**

Conduit and fittings shall be suitable for above ground use indoors or outdoors exposed to sunlight and weather, and for underground use by direct burial or encasement in concrete.

Conduit and fittings shall not have any features that can abrade or otherwise damage cable.

Conduit and fittings shall be provided with a primary coating of zinc.

Dimensional information cited in Sections 4.2 through 4.5 should be consistent with UL requirements and is provided for the convenience of Seattle City Light design engineers, construction crews, inspectors, and quality assurance personnel who do not have ready access to UL 6.

**MATERIAL STANDARD**

Zinc-Coated Steel Conduit and Fittings

standard number: **7050.05**

superseding: August 14, 2015

effective date: November 6, 2019

page: 2 of 4

**4. Detailed Requirements, continued**

**4.2 Straight Section Conduit**

Conduit shall be listed by Underwriters Laboratories, Standard UL 6.

Each straight conduit section shall be finished with one threaded coupling attached.



**Table 4.2. Conduit**

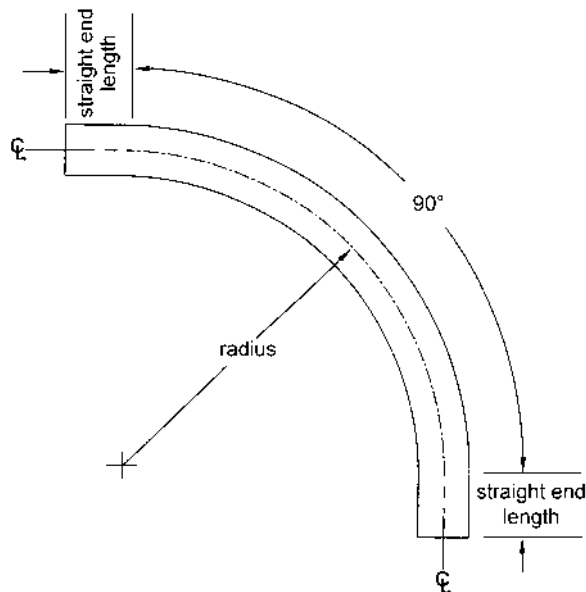
Stock No.	Trade Size (in)	Outside Diameter min (in)	Outside Diameter average (in)	Outside Diameter max (in)	Inside Diameter nom (in)	Wall Thickness nom (in)	Weight min (lbs / ft)
012085	1/2	0.825	0.840	0.855	0.632	0.104	0.79
012086	3/4	1.035	1.050	1.065	0.836	0.107	1.05
012087	1	1.300	1.315	1.330	1.063	0.126	1.53
734740	1-1/2	1.885	1.900	1.915	1.624	0.138	2.49
734741	2	2.351	2.375	2.399	2.083	0.146	3.32
734742	2-1/2	2.846	2.875	2.904	2.489	0.193	5.27
734743	3	3.465	3.500	3.535	3.090	0.205	6.82
734744	3-1/2	3.960	4.000	4.040	3.570	0.215	8.31
734745	4	4.455	4.500	4.545	4.050	0.225	9.27
734747	5	5.507	5.563	5.619	5.073	0.245	13.1

**4.3 Elbows**

Elbows shall be listed by Underwriters Laboratories, Standard UL 6.

Elbow angles shall be accurate to +/- 2% of specified.

**Figure 4.3a. Conduit Elbows**



**MATERIAL STANDARD**

Zinc-Coated Steel Conduit and Fittings

standard number: **7050.05**

superseding: August 14, 2015

effective date: November 6, 2019

page: 3 of 4

**4. Detailed Requirements, continued****4.3 Elbows, continued****Table 4.3b. Standard Sweep Elbows**

Stock No.	Trade Size (in)	Degree Bend	Radius (in)	Straight End Length (in)
734805	3/4	90	4-1/2	1-1/2
734806	1	"	5-3/4	1-7/8
734808	1-1/2	"	8-1/4	2
734809	2	"	9-1/2	2
734810	2-1/2	"	10-1/2	3

**Table 4.3c. Large Sweep Elbows**

Stock No.	Trade Size (in)	Degree Bend	Radius (in)	Straight End Length (in)
734820	2	90	36	11
734821	2-1/2	"	36	11
734822	3	"	36	11
734823	3-1/2	"	36	11
734824	4	"	36	11
012176	4	"	48	12
734826	5	"	60	12
013749	4	22-1/2	48	12
013750	4	45	48	12
014580	3	90	24	9
014581	4	90	24	11

**4.4 Threaded Couplings**

Threaded couplings shall be listed by Underwriters Laboratories, Standard UL 6.

Threaded couplings shall be straight-tapped.

**Table 4.4. Straight Threaded Couplings**

Stock No.	Trade Size (in)
731091	1/2
731092	3/4
731093	1
731094	1-1/4
731095	1-1/2
731096	2
731097	2-1/2
731098	3
731099	3-1/2
731100	4
731102	5





**4. Detailed Requirements, continued****4.5 Nipple Stock**

Nipple stock shall be provided in three-foot lengths.

**Table 4.5.** Nipple Stock

Stock No.	Trade Size (in)	Threads per in
734868	1/2	14
734869	3/4	14
734870	1	11-1/2
734872	1-1/2	11-1/2
734873	2	11-1/2
734874	2-1/2	8

**Figure 4.5.** Nipple Stock**5. Marking**

Each straight length of finished conduit, elbow, and threaded coupling shall be marked according to the requirements of UL 6, Section 7. This marking shall include, but not be limited to:

- Manufacturer's name or symbol
- "electrical rigid metal conduit" or "ERMC-S" (conduit and elbows only)
- "EC" (couplings only)

**6. Testing**

Conduit and fitting test data that establishes compliance with the requirements of UL 6 and this material standard shall be provided upon request.

**7. Packaging**

Straight conduit shall be furnished in 10 ft sections unless specified otherwise on the purchase order.

Each bundle shall be legibly marked with the following information:

- Manufacturer's identification
- Product description
- Seattle City Light's Purchase Order Number
- Seattle City Light's Stock Number
- Gross, net, and tare weight

**8. Shipping**

Conduit may be delivered on enclosed, covered, or flatbed trucks. If conduit is delivered on a flatbed truck, conduit shall be side-loaded.

Because Washington State law requires a 10-inch minimum side board when driving a forklift or pallet jack onto the bed of a truck or trailer, most flatbed trucks or trailers must be side-loaded to ease off-loading.

**9. Issuance**

Conduit FT  
Fittings EA

**10. Approved Manufacturers**

Allied Tube and Conduit	Shamrock
Cal Conduit Products	Steelduct
Conduit Pipe Products	Torrance
Occidental	Triangle
Picoma	Western
Republic	Wheatland

**11. References**

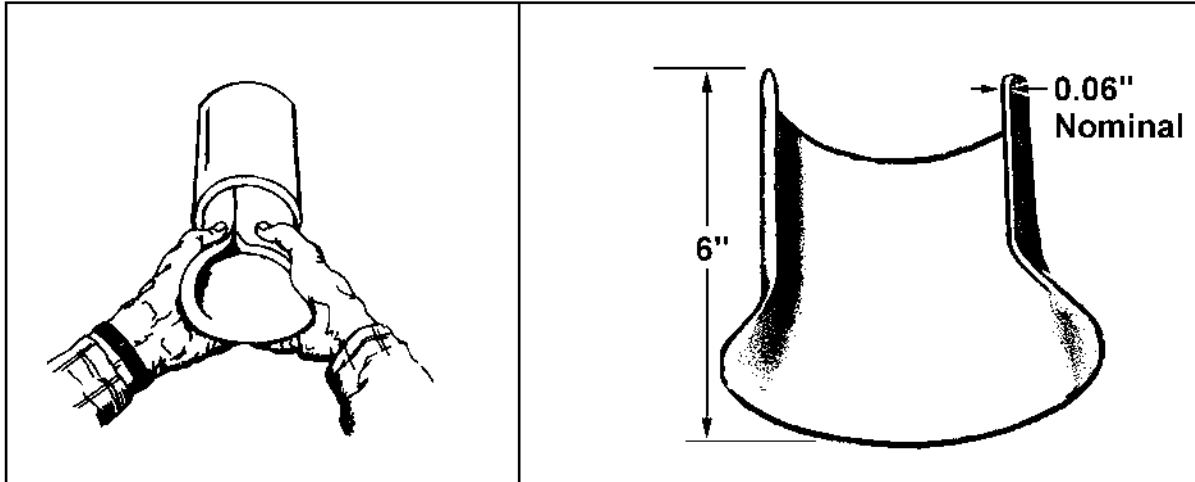
**7347.5;** "Conduit and Fittings, Rigid Steel, Galvanized" (canceled); Material Standard; SCL

**7347.6;** "Elbow, 90° Large Sweep, Rigid Galvanized Steel Conduit" (canceled); Material Standard; SCL

**9220.05;** "Electric Power Cable and Conduit Application" (in development); Design Standard; SCL

**Shipek, John;** SCL Standards Supervisor, subject matter expert and originator of 7050.05 (john.shipek@seattle.gov)

**Conduit Fitting, Cable Protector**



**Cable Protectors** for installation in duct and conduit ends shall be of the configuration shown, and shall be made from stress-relieved virgin nylon meeting the requirements of ASTM D789 or high-density polyethylene meeting the requirements of ASTM D1248. The material shall have the following additional requirements.

- Exceptional resistance to abrasion
- Low coefficient of friction
- Burning rate of 1.04"/minute or slower per ASTM D635
- Temperature range: -20 to +90°C., and retain uniform characteristics
- Resistant to weak acids and alkalis
- Color shall be white, light gray or other light colors which can be written on with a black marker. Black is unacceptable.

**Reference Specification:** ASTM D789, ASTM D1248, ASTM D635

**Stock Unit:** EA

Stock Number	Conduit Size (in)	Approved Manufacturers			
		Virginia Plastics	Anchor Industrial Plastics	Condux	Electrical Materials Co. (EMCO)
731800 E	2 to 2½	LG-225	APCP-2	80423-01	27-2 Grey
731801 E	3 to 6	LG-345	APCP-3	80423-00	27-1 Grey

In October 2015, this standard was renumbered from 7318.1 to 7050.09.

Standards Coordinator  
 Laura Vanderpool

Standards Supervisor  
 John Shippek

Unit Director  
 Darnell Cola

## DB120, PVC Conduit Fittings

**1. Scope:** This specification is for polyvinyl chloride (PVC) plastic utilities fittings suitable for underground installations: Type DB-120.

The fittings shall comply with the latest revision to NEMA TC 9, "Fittings for Polyvinyl Chloride (PVC) Plastic Utilities Duct for Underground Installation."

**2. Fittings** shall be furnished in the sizes and types specified on the purchase order. Sockets shall be in accordance with Table 2-2 or 2-3 of NEMA TC 9. Plugs and end bells shall be in accordance with Tables 2-12 and 2-7 or 2-8, respectively, of NEMA TC 9.

**3. Color:** Fittings shall be medium to dark gray in color.

**4. Markings:** In addition to the marking requirements of NEMA TC 9, each shipping lot shall be marked with the City purchase order number, gross and net weights, and the name and address of the manufacturer.

**5. Reference Specification:** NEMA TC 9, ASTM D 2672, ASTM F 512 (latest revisions)

**6. Stock Unit:** EA

End Bells (see note 1)		Plugs (see note 2)	
Stock No.	Size, nominal (in)	Stock No.	Size, nominal (in)
734944	2	734938	2
734946	3	734940	3
734947	3-1/2	—	—
734948	4	734942	4
734949	5	734943	5
010340	6	010338	6

**Notes**

1. Approved end bell manufacturers: Carlon; Kraloy; PW Eagle Inc., dba PWPipe; Scepter.
2. Approved plug manufacturer: Carlon only.
3. For regular couplings and adapters and 45° and 90° bends, refer to SCL 7020.05..

**7. Adapter:** 3-1/2" nominal round to 3-1/2" nominal square by 24" long.

Stock No. 734565

Approved adapter manufacturers: Carlon; J-M Manufacturing Inc.; Picoma; PW Eagle Inc., dba PWPipe; Raceways Tech.

**8. References**

**SCL Material Standard 7015.05;** "Schedule 40 PVC Conduit and Fittings"

**SCL Material Standard 7345.7;** "DB120, PVC Conduit Fittings" (renamed and renumbered to 7055.09 in October 2015)

Standards Coordinator  
 Laura Vanderpool

Standards Supervisor  
 John Shippek

Unit Director  
 Darnell Cola





## Fluidized Thermal Backfill



### 1. Scope

This standard covers the requirements for the formulation of thermally conductive concrete and low strength material used in the construction of encased electrical conduits (duct banks) including high strength Fluidized Thermal Backfill (FTB) and low strength Fluidized Thermal Backfill. Because FTB is a mixed-to-order product, it is not stocked in Seattle City Light (SCL) inventory.

This standard applies to the following SCL stock numbers:

Stock No.	Description	Unit
013711	High strength FTB	CYU
013712	Low strength FTB	CYU

### 2. Application

Fluidized Thermal Backfill (FTB) is used to encase and cover underground power conduits that will contain transmission or distribution cables which may operate at or above normal ampere capacity (ampacity). FTB transfers heat away from power cables, allowing them to conduct more power.

Low-strength FTB is used like controlled density fill (CDF) to backfill trenches over the high-strength FTB duct banks, and also for encasement where high-strength is not desired. It provides superior thermal properties to other backfills, and is self-compacting.

High-strength FTB is used like concrete for duct bank encasement. It provides maximum protection against dig-ins and undermining during future excavations. As a rule, high-strength FTB is more thermally conductive than low-strength FTB, but it is much more difficult to remove in future excavations.

FTB is normally not required for vault, manhole, or handhole backfill.

Admixtures must be pre-approved by SCL.



### 3. Industry Standards

Backfill shall meet the requirements of the latest revisions of the following industry standards:

**ASTM C31/C31M**; Standard Practice for Making and Curing Concrete Test Specimens in the Field

**ASTM C39/C39M**; Standard Test Method for Compressive Strength of Cylindrical Concrete Specimens

**ASTM C136**; Standard Test Method for Sieve Analysis of Fine and Coarse Aggregates

**ASTM C143**; Standard Test Method for Slump of Hydraulic Cement Concrete

**ASTM C150**; Standard Specification for Portland Cement

**ASTM C618**; Standard Specification for Coal Fly Ash and Raw or Calcined Natural Pozzolan for Use in Concrete

**ASTM C989**; Standard Specification for Ground Granulated Blast-Furnace Slag for Use in Concrete and Mortars

### 4. Mix Design & Requirements

#### 4.1 General Requirements

The contractor shall provide a FTB mix design which meets the performance requirements outlined in Table 4.

FTB mix designs must specify the source of all FTB component materials, including the source pit for aggregate materials. The maximum aggregate is 3/8 in.

FTB mix designs must be engineered by a Seattle City Light-approved consultant.

FTB component materials may include:

- 3/8-in minus (medium) aggregate – ASTM C136 Sieve Analysis required for approval
- Building sand (fine aggregate) – ASTM C136 Sieve Analysis required for approval
- Portland Cement – type I per ASTM C150
- Fly Ash – Class F as per ASTM C618-05
- Ground Granulated Blast Furnace Slag – ASTM C989-05
- Water – clean potable water required, or as approved by SCL
- Red concrete dye, where specified by Seattle City Light engineering. Red dye should be added at the equivalent of 4 pounds of red oxide per cubic yard.

**Table 4. Performance Requirements**

Criteria	Unit	Low Strength FTB		High Strength FTB		Testing Method
		Mix Design	Field Test	Mix Design	Field Test	
Thermal Resistivity						
Maximum at 0% Moisture Content	(°C-cm)/W	100	100	75	75	Consultant
Maximum at Critical Moisture Content	(°C-cm)/W	70	80	60	65	Consultant
Minimum 28-Day Compressive Strength	lb/sq-in	100	100	3000	3000	ASTM C873
Maximum 28-Day Compressive Strength	lb/sq-in	130	150	none	none	ASTM C873
Minimum Slump	in	6	6	6	6	ASTM C143
Maximum Slump	in	9	9	9	9	ASTM C143

#### **4.2 Mix Design Criteria**

FTB mix designs shall meet or exceed the performance requirements cited in Table 4.

#### **4.3 Air Content**

The total air content of any FTB mix shall not exceed 2% by volume. No air entraining admixtures will be permitted.

#### **4.4 Substitutions**

No substitutions allowed for any component material without permission of Seattle City Light.

#### **4.5 Withdrawal of Mix Design Approval**

SCL reserves the right to temporarily suspend or permanently withdrawal approval of any mix design.

#### **4.6 Admixtures**

Admixtures must be approved for use in FTB by Seattle City Light. When allowed, the admixture shall be added per manufacturer recommendation.

#### **4.7 Accelerating Admixture**

The following accelerating admixture is approved for use in Seattle City Light FTB: Pozzolite NC 534, manufactured by BASF Admixtures, Inc.

#### **4.8 Fluidizers**

Seattle City Light-approved fluidizers may be used interchangeably where produced under the same ASTM specification. Unapproved fluidizers are not interchangeable with approved fluidizers.

For example, approved fly ash (ASTM C618) may be used in any mix design that specifies fly ash but it may not be substituted for blast furnace slag (ASTM 989) in another mix design. Also, an unapproved fly ash may not be substituted for an approved fly ash.

Fluidizer approval requires formulation of a mix design through an approved consultant, and two compliance certification reports that demonstrate consistent physical properties over a six-month period. Seattle City Light may withdraw approval at any time.

High-strength FTB mix designs may be formulated without fluidizer. Low-strength FTB mix designs must be formulated with fluidizer.

---

### **5. Producers Identification Codes**

FTB mix designs must be designated as follows on all mix designs, submittals and delivery tickets:

- High Strength FTB – SCLHSFTB
- Low Strength FTB – SCLLSFTB

The addition of red dye must also be indicated.

Product codes and mix ID codes of individual suppliers will not be accepted.

## 6. Approval of FTB Mix Design

### 6.1 Submittals

The Contractor shall submit a mix design to SCL for all classes of concrete specified.

The Contractor’s submittal of a mix design shall contain a unique identification, as per section 5, for each mix design, and shall include the mix proportions per cubic yard, the proposed sources, admixtures, the average 28-day compressive strength (as per ASTM C873), thermal resistivity testing including thermal dry graphs and the water cement ratio.

Test results for compressive strength and thermal resistivity included in the mix design submittal shall not be more than 60 days old.

The Contractor shall notify SCL in writing of any mix design modifications.

### 6.2 Expiration

Mix designs are approved for a period of one year from the date of SCL approval.

Expired mix designs will not be permitted for use on Seattle City Light projects.

A mix design may be renewed by resubmitting the mix design, including up to date strength and thermal resistivity test results.

## 7. Approved Suppliers and Mix Designs

Supplier	Stock No. 013711		Stock No. 013712	
	High Strength FTB Mix ID	Expiration Date	Low Strength FTB Mix ID	Expiration Date
Salmon Bay Sand and Gravel	SCLHSFTB	2/28/2021	SCLLSFTB	2/28/2021
Stoneway Concrete (Plant 11)	SCLHSFTB	5/5/2021	SCLLSFTB	5/5/2021
Stoneway Concrete (Plant 12)	SCLHSFTB	5/5/2021	SCLLSFTB	5/5/2021
Stoneway Concrete (Plant 14)	SCLHSFTB	5/5/2021	SCLLSFTB	5/5/2021
Cadman	SCLHSFTB	9/2/2021	SCLLSFTB	9/2/2021
CalPortland	SCLHSFTB/505	9/30/2021	SCLLSFTB	9/30/2021

## 8. Sources

**Detter, Chris**; SCL Engineer and originator of 7150.00

**Lu, Curtis**; SCL Standards Engineer and subject matter expert for 7150.00

**Read, Steven**; SPU Materials Engineering Supervisor and subject matter expert for 7150.00

**SCL Construction Standard 0226.06**; “Fluidized Thermal Backfill”

**Stewart, Bob**; SCL Civil Inspector, subject matter expert and major contributor to 7150.00

**Brissette, Andrew**; Civil Engineer Specialist Senior and subject matter expert for 7150.00

## Precast Reinforced Concrete Handholes, General Requirements



### 1. Scope

This material standard covers the general requirements for precast reinforced concrete handholes used at Seattle City Light (SCL).

Specific requirements shall be according to the detailed material standards and purchase orders issued.

### 2. Application

These precast handholes are intended for use in the construction of underground electric systems. The precast concrete handhole may be used to house equipment, cables, service connections, fuses and splices for the secondary distribution system and streetlight system. Precast handholes are not intended to be placed in locations subjected to continuous traffic loading.

### 3. Definitions

**Handhole** as defined by National Electrical Safety Code (NESC): An access opening, provided in equipment or in a below-the-surface enclosure in connection with underground lines, into which personnel reach but do not enter, for the purpose of installing, operating, or maintaining equipment or cable or both.

**Handhole** as defined by SCL: An enclosure that is used for secondary service and/or streetlight system. Enclosures 233 or smaller.

Standards Coordinator  
Quan Wang

Standards Supervisor  
John Shipek

Unit Director  
Andrew Strong



#### 4. Industry Standards

Handholes shall meet the applicable requirements of the following industry standards:

**ACI 318-11**; “Building Code Requirements for Structural Concrete and Commentary”

**ANSI/AWS D1.4/D1.4M-11**; “Structural Welding Code – Reinforced Steel”

**ASTM A123/A123M-08**; “Standard Specification for Zinc (Hot-Dip Galvanized) Coatings on Iron and Steel Products”

**ASTM A185/A185M-07**; “Standard Specification for Steel Welded Wire Reinforcement, Plain, for Concrete”

**ASTM A497/A497M-07**; “Standard Specification for Steel Welded Wire Reinforcement, Deformed, for Concrete”

**ASTM A615/A615M-09b**; “Standard Specification for Deformed and Plain Carbon-Steel Bars for Concrete Reinforcement”

**ASTM A706/A706M-09b**; “Standard Specification for Low-Alloy Deformed and Plain Bars for Concrete Reinforcement”

**ASTM C39/C39M-10**; “Standard Test Method for Compressive Strength of Cylindrical Concrete Specimens”

**ASTM C150/C150M-12**; “Standard Specification for Portland Cement”

**ASTM C478-09**; “Standard Specification for Precast Reinforced Concrete Manhole Sections”

**ASTM C857-11**; “Standard Practice for Minimum Structural Design Loading for Underground Precast Concrete Utility Structures”

**ASTM C858-10e1**; “Standard Specification for Underground Precast Concrete Utility Structures”

**National Electric Safety Code (NESC) C2-2012, Rule 094B6**; “Concrete-Encased Electrodes”

---

#### 5. Conflict

Where conflict exists, the following order of precedence shall apply:

1. Seattle City Light purchase order (PO)
2. Seattle City Light General Terms and Conditions
3. Detailed material standards
4. This standard
5. ASTM standards
6. Other industry standards

---

#### 6. Dimensions

Manufacturers, the Washington State Department of Transportation (WSDOT) and the City of Seattle Standard Plan No 550A may refer to the different sizes of handhole by name and type. Table 6 summarizes the agreed-upon dimensions.

**Table 6. Handhole Names, Types and Dimensions**

Name	Type	Overall Dimensions Nominal (in)			Inside Dimensions Nominal (in)		
		Width	Length	Height	Width	Length	Height
1419	1	17	22	12	14	19	12
1728	2	21	32	12	17	28	12
3030	None	30	30	25.5	23.5	23.5	24
231	3	32	44	18.75	24	36	12
233	5	32	44	42	24	36	31.5
444	6	48	48	50	40	40	37

## 7. Structural and Construction

### 7.1 General

Handholes shall be precast concrete, reinforced, and of the type and size indicated on Seattle City Standard Plan no. 550, SCL detailed material standards and this standard.

Design changes shall require the prior written approval of an SCL Standards Engineer or Civil Engineer.

### 7.2 Reinforced Concrete

Minimum compressive strength of concrete shall not be less than 4,000 pounds per square inch in 28 days as determined by the ASTM Method C39.

Cement shall conform to ASTM C150.

No additives containing calcium chloride or any other material that will produce corrosive ions shall be used in the concrete.

Welded wire fabric shall conform to ASTM A185 or A497.

Steel Reinforcing Bars shall conform to ASTM A615, Grade 60 or ASTM A706, Grade 60.

Welding of reinforcing steel shall conform to the Structural Welding Code, Reinforcing Steel (AWS D1.4) of the American Welding Society.

The concrete cover (measured from the surface of the concrete to the outside surface of the reinforcement) for reinforcement shall be 1-1/2 in minimum for main reinforcing bars and 3/4 in for stirrups and ties.

The concrete finish shall be free of rock pockets and honeycombed areas.

The interior walls, ceiling and exterior surfaces exposed shall be smooth.

Rock pockets over 3/8-in deep and other imperfections on all surfaces shall be patched and troweled to match the surrounding surface.

### 7.3 Structural Design

Structural design of the precast handhole shall conform to ACI 318 – “Building Code Requirements for Structural Concrete,” and ASTM C857, “Minimum Structural Design Loading for Underground Precast Concrete Utility Structures,” with the following clarifications:

- Live Load: AASHTO HS-20 truck, P=16 kips. Traffic can approach the structure from any direction.
- 30% Live load impact load factor for soil cover less than or equal to 2 ft
- No live load surcharge for soil cover greater than 8 ft
- Soil density = 120 pcf
- 40 pcf Equivalent Fluid Pressure Lateral Soil Pressure Above Water Table
- 80 pcf Equivalent Fluid Pressure Lateral Soil Pressure Below Water Table
- 80 psf Live Load Surcharge

---

### 8. Grounding

All handhole bodies shall be supplied with a grounding connector; 1/4-in ground insert/bolt.

Grounding connector shall be electrically bonded to the frame of the handhole.

Type 1 and Type 2 handhole bodies shall have a 5/16-in ground insert or a grounding pad.

All Type 1 and Type 2 handhole lids shall be supplied with at least a 4-ft length copper braid (ground strap).

---

### 9. Knockouts

All knockout edges shall be beveled.

Each enclosure with a floor shall have a ground-rod knockout at two corners of the base of the enclosure.

Size, shape, quantity and location of knockouts shall be specified in detailed material standards.

---

### 10. Access Covers: Hatches, Lids, and Round Covers

Handholes and enclosures use different types of access covers.

Access covers may refer to the following:

- Hatches: Hinged metal doors with support struts and recessed handles
- Lids: Unhinged rectangular metal plates
- Round covers: Unhinged, typically made of ductile iron

Access covers shall be provided with a grounding site per manufacturer standards and detailed material standards.

Access covers shall be designed for a 16 kips wheel load (H2O + 30% impact) applied in any direction.

Access covers shall have an anti-corrosion coating which shall remain durable and fracture- and delamination-free over the expected life of the product.

Hatches and lids shall have non-slip surfaces as shown in Table 10.

**Table 10. Non-Slip Surface Requirements**

<b>Attribute</b>	<b>Requirement</b>
Minimum coefficient of friction	0.8
Bond strength to the plate	3000 psi or greater
Surface hardness	55 minimum on the Rockwell "C" scale
Non-slip coating	SlipNot Grade 3 or Thermion TH604

**10.1 3030, 231 (Type 3), and 233 (Type 5) Access Covers: Hatches**

3030, Type 3, and Type 5 handholes use hatch-type access covers.

Hatches shall:

- Be hinged
- Include one, 5/8-inch diameter bonding hole located in an underside bearing bar, approximately centered in the door and 2-1/2 to 3-1/2 inches from the hinged edge
- Fully open 180 degrees
- Be hot-dipped galvanized in accordance with ASTM A153
- Not exceed 55 pounds equivalent lift
- Have a locking mechanism, such as a Penta head bolt, to prevent unsolicited access
- Have support struts and a recessed handle

**10.2 1419 (Type 1) and 1728 (Type 2) Access Covers: Lids**

Type 1 and Type 2 handholes use lid-type access covers.

Lids shall:

- Be at least 5/16-inch-thick steel and shall be hot-dipped galvanized in accordance with ASTM A 153.
- Have tab(s) to lock onto the non-slip frame of the handhole body
- Have a locking mechanism, such as a Penta head bolt, to prevent unsolicited access

**10.3 444 (Type 6) Access Covers (Hatches or Round Covers)**

444 enclosure access covers may either be hatches (typical) or round covers (special applications).

Hatches shall:

- Be hinged
- Include one, 5/8-inch diameter bonding hole located in an underside bearing bar, approximately centered in the door and 2-1/2 to 3-1/2 inches from the hinged edge
- Be hot dipped galvanized in accordance with ASTM A153
- Fully open 180 degrees
- Not exceed 55 pounds equivalent lift
- Have a locking mechanism, such as a Penta head bolt, to prevent unsolicited access
- Have support struts and two recessed handles

Round covers shall comply with SCL 7204.70.

## 11. Identification

Hatches and lids shall be identified clearly on the top of the lid/hatch with 3-inch-high letters.

**Table 11. Hatch and Lid Identification Requirements**

<b>Label</b>	<b>Handhole Occupant/Usage</b>
SCL	Secondary Distribution
SL	Streetlight Only
SL/SDOT	Streetlight and Seattle Department of Transportation (Traffic Control) – Joint Use
SCL COMM	Seattle City Light Communications

Marking shall be accomplished by welding, cast onto the cover, or tightly fastened label plate. Label plates and letters shall be hot-dipped galvanized.

Hatches and lids shall be identified with permanent marking on the underside with the type of surface ("S3" for SlipNOT® 3, TH604 for Thermion TH604), and the year of manufacture.

This permanent marking shall be clearly legible.

---

## 12. Documentation

### 12.1 General

Documentation shall be in English and use customary inch-pound units.

Documentation shall utilize common industry terminology and well-understood abbreviations.

### 12.2 Bidder's Data

Bidder shall return the following technical information with their bids:

- Manufacturer name
- Manufacturing plant location (all possible)

Bid information shall be presented in a clear and consolidated manner for ease of review.

---

## 13. Approved Manufacturers

Approved manufacturers are identified in the detailed material standards.

---

## 14. References

**SCL Material Standard 7204.70**, "Frames and Covers, 42-Inch Round, Iron"

---

## 15. Sources

**Detter, Chris**; SCL Distribution Engineer and subject matter expert for 7203.01

**SCL Material Standard 7203.04**; "3030 Handhole, Precast, Secondary"

**SCL Material Standard 7203.08**; "Handhole, 2" x 3" x 3" Precast"

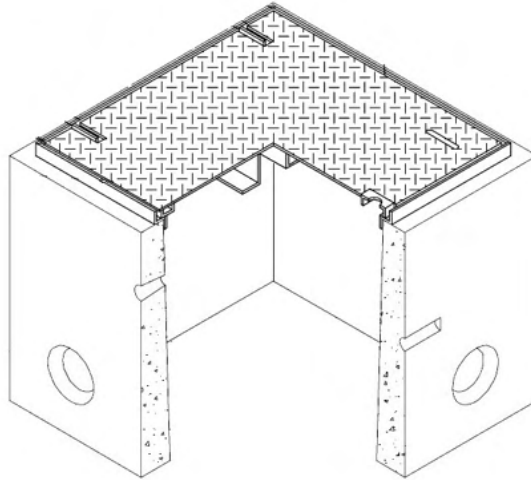
**SCL Material Standard 7203.10**; "Type 1 and Type 2 Handhole, Precast, Secondary and Streetlight"

**SCL Material Standard 7203.21**; "Precast Reinforced Concrete Structures – General"

**SCL Material Standard 7203.26; "444 Enclosures, Precast"**

**Wang, Quan;** SCL Standards Engineer and subject matter expert for 7203.01

## 3030 Handhole, Precast, Secondary



### 1. Scope

This standard covers the requirements for 3030 precast secondary handhole bases, frames and covers. Components can be ordered separately, or they can be ordered as an assembled handhole unit with cover.

This standard applies to the following Seattle City Light (SCL) stock numbers:

Stock No.	Description
013186	3030 handhole base with frame and cover (labeled "SCL")
013187	3030 handhole, base only
013188	3030 handhole frame and cover assembly (labeled "SCL")

### 2. Application

Handholes are used to house secondary service connections.

Handholes are for use in pedestrian sidewalks where an occasional car or light truck may inadvertently traverse.

### 3. General Requirements

This detailed standard is to be used in conjunction with the latest version of SCL Material Standard 7203.01, "Precast Reinforced Concrete Handholes, General Requirements."

Standards Coordinator  
Quan Wang

Standards Supervisor  
John Shipek

Unit Director  
Andrew Strong

**4. Construction - Component Requirements**

**4.1 Grounding and Bonding Requirements**

The handhole base shall be provided with a grounding insert.

The metal frame shall be provided with a grounding lug.

**4.2 Handhole Base**

The SCL 3030 handhole base (Stock No. 013187) shall have dimensions and features as shown in Tables 4.2a and 4.2b, and Figure 4.2.

**Table 4.2a. Handhole Dimensions (Nominal)**

Stock No.	Item	Outside (in)			Inside (in)		
		Length	Width	Height	Length	Width	Cover Label
013186	Handhole base, frame and cover	30	30	25.5	24	24	SCL
013187	Handhole base only	30	30	24	24	24	–
013188	Frame and cover only	28	28	1.5	25	25	SCL

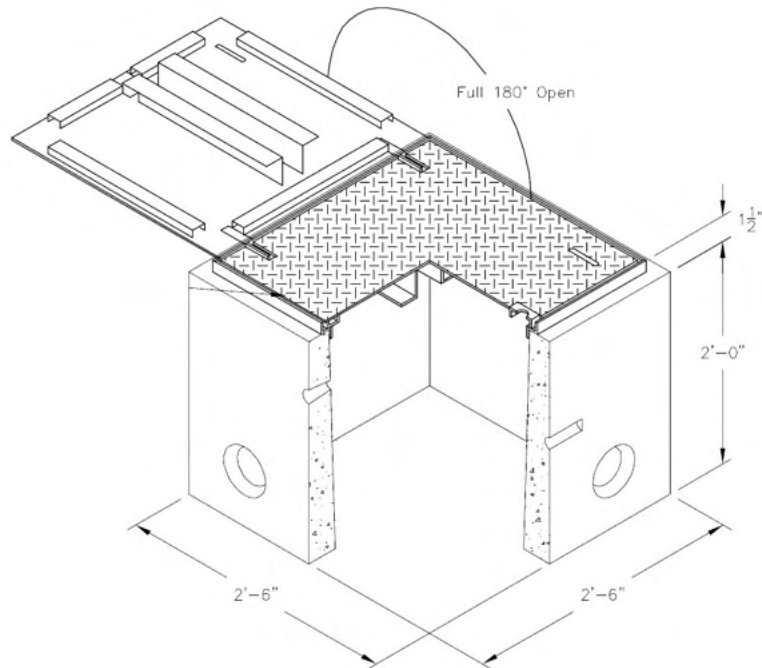
**Table 4.2b. Handhole Features**

Feature	Size, Nominal (in)	Location	Per Location	Total No.
Knockouts, round	5 dia	All 4 walls, on bottom	2 ea side	8
Lift Holes	1-1/2 dia	Upper center on 2 walls, opposite	1 ea side	2
Ground Inserts, bronze	1/4 dia	One wall, internal	1 ea side	1

Note: Approximate weight is 700 pounds.



**Figure 4.2. 3030 Handhole**



**4.3 Frame and Cover**

The 3030 frame and cover assembly (Stock No. 013188) shall have dimensions and features as shown in Table 4.3 and Figure 4.3.

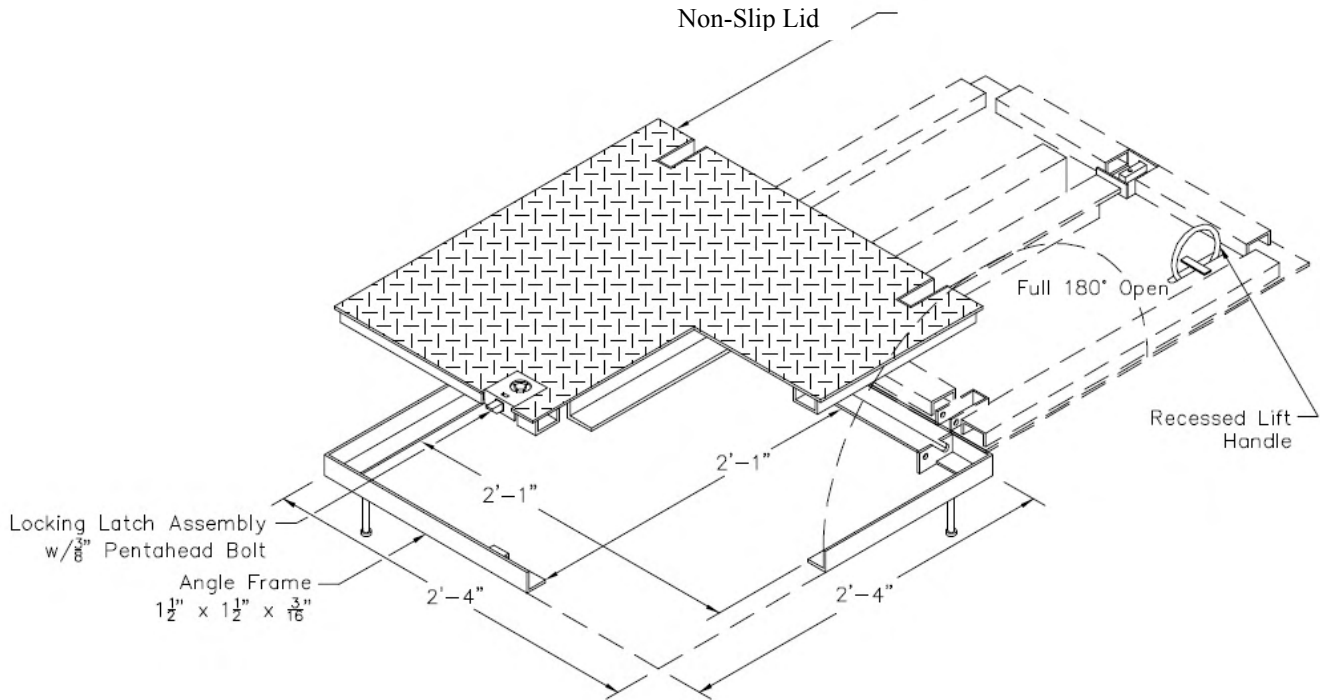
The cover and frame shall be made of slip resistant steel plate

The angle frame shall be securely anchored in the concrete.

**Table 4.3. Frame and Cover Features**

<b>Non-Slip Surface, (COF)</b>	0.8
<b>Galvanizing</b>	Hot-Dipped Galvanized
<b>Load Rating</b>	H-20
<b>Grounding</b>	Inserts or Lugs
<b>Locking Device</b>	Penta-Bolt Lock
<b>Lift Handle</b>	Recessed Lift Handle

**Figure 4.3. 3030 Frame and Cover**



**5. Issuance**

EA

**6. Approved Manufacturers**

Stock No.	Description	OldCastle Precast / Utility Vault
013186	3030 handhole base with frame and cover	3030 LA Handhole-SCL-3150010
013187	3030 handhole, base only	3030-B
013188	3030 handhole frame and cover	3030-TC-NSA Non-Slip Door Marked SCL-3150010

**7. References**

**ASTM A123M-08**; "Standard Specification for Zinc (Hot-Dip Galvanized) Coatings on Iron and Steel Products"

**Detter, Chris**; SCL Distribution Engineer and subject matter expert for 7203.04

**Ng, Sharon**; SCL Civil Engineer and subject matter expert for 7203.04

**SCL Material Standard 7203.01**; "Precast Reinforced Concrete Handholes, General Requirements"

**Standard Plan 550a**; "Handholes;" City of Seattle; Public Utilities  
[http://www.seattle.gov/util/stellent/groups/public/@spu/@esb/documents/webcontent/spu01\\_003112.pdf](http://www.seattle.gov/util/stellent/groups/public/@spu/@esb/documents/webcontent/spu01_003112.pdf)

**Standard Plan J-40.10-00**; "Locking Lid Standard. Junction Box Types 1 & 2;" Washington State Department of Transportation;  
[http://www.wsdot.wa.gov/publications/fulltext/Standards/4\\_09StdPlanmanual.pdf](http://www.wsdot.wa.gov/publications/fulltext/Standards/4_09StdPlanmanual.pdf)

**Wang, Quan**; SCL Standards Engineer, originator and subject matter expert for 7203.04

## 231 and 233 Handholes, Precast, Secondary and Streetlight, Detailed



### 1. Scope

This standard covers the detailed requirements for the precast 231 and 233 handhole bases, covers, and hatches; and the assembled 213 and 233 handhole units. Components can be ordered separately or ordered as an assembled unit.

Manufacturers, Washington State Department of Transportation (WSDOT) and City of Seattle Standard Plan No 550A refer to the 231 handhole as a Type 3 handhole and the 233 handhole as a Type 5 handhole.

This standard applies to the following Seattle City Light (SCL) stock numbers:

Stock No.	231 and 233 Handhole Components and Assemblies
013182	Base, 231 handhole
013183	Base, 233 handhole
013184	Cover with hatch, "SCL"
013185	Cover with hatch, "SL"
013484	Cover with hatch, "SL/SDOT"
013180	Assembly, 231 handhole base with cover, "SCL"
013181	Assembly, 231 handhole base with cover, "SL"
720388	Assembly, 233 handhole base with cover, "SCL"
013179	Assembly, 233 handhole base with cover, "SL"
013485	Assembly, 233 handhole base with cover, "SL/SDOT"

Standards Coordinator  
Quan Wang

Standards Supervisor  
John Shipek

Unit Director  
Andrew Strong

## 2. Application

Handholes are used to house secondary service and streetlight service connections.

Handholes are for use in pedestrian sidewalks where an occasional car or light truck may inadvertently traverse.

## 3. General Requirements

This standard is to be used in conjunction with the latest version of SCL 7203.01, "Precast Reinforced Concrete Handholes, General Requirements."

## 4. Handhole Base

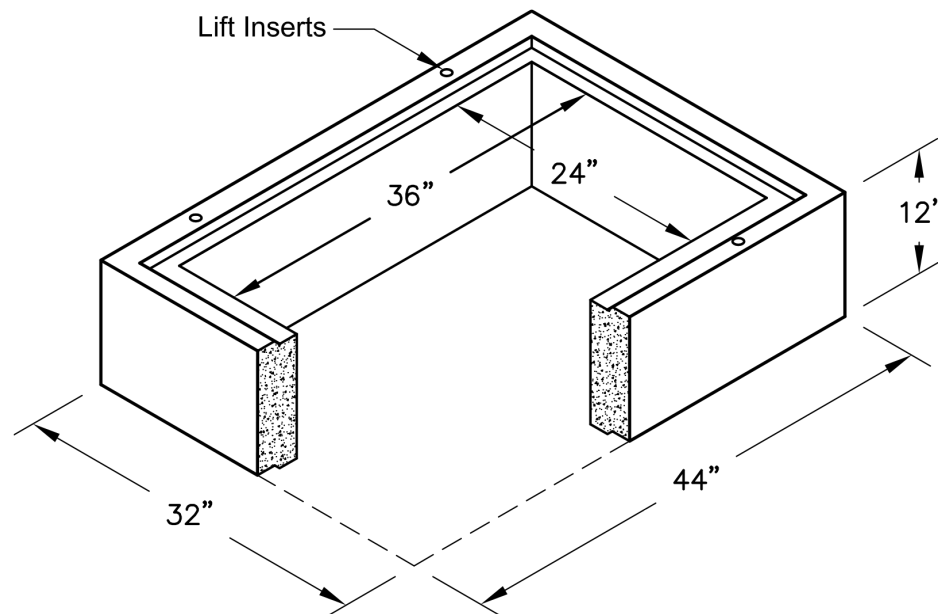
### 4.1 231 Handhole Base (Stock No. 013182)

Handhole base shall have four 3/4 in diameter lift inserts (2 each along the length of handhole), as shown in Figure 4.1.

Dimensions shall as shown in Figure 4.1.

Top of handhole base shall have a keyway to allow proper fit with the cover.

**Figure 4.1. 231 Handhole Base**



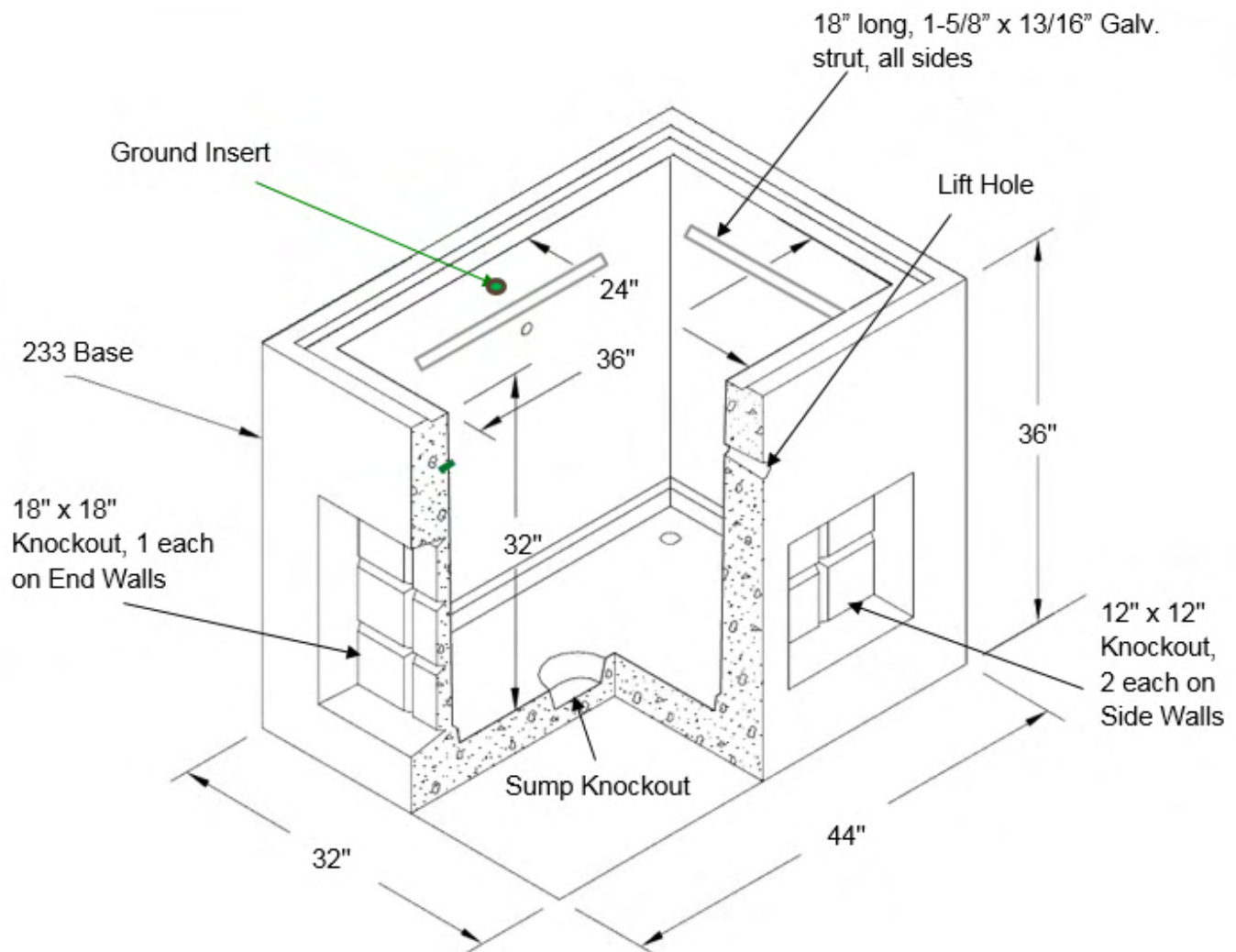
**4.2 233 Handhole Base (Stock No. 013183)**

233 handhole bases shall have the following attributes:

- Knockouts
  - Waffle (4–6 in squares), 12 in x 12 in on both side walls
  - Waffle (9–6 in squares), 18 in x 18 in on both end walls
  - Ground rod, 1 in diameter at 2 opposite corners of floor
- Galvanized "C" channel, embedded in all walls, 1-5/8 in x 13/16 in x 18 in long
- Sump, round, 6 in diameter, 3 inches deep, off center on floor
- Pulling Irons, 1/2 in diameter, as requested per project
- Lift Holes, 1-1/2 in diameter on center of wall
- Ground Inserts, bronze, 1/4 in diameter, on the side wall, centered, above lift hole

Dimensions shall be as shown in Figure 4.2.

**Figure 4.2. 233 Handhole Base**



## 5. Covers

Cover shall consist of a concrete collar with a 24 in by 36 in slip-resistant steel hatch with steel frame.

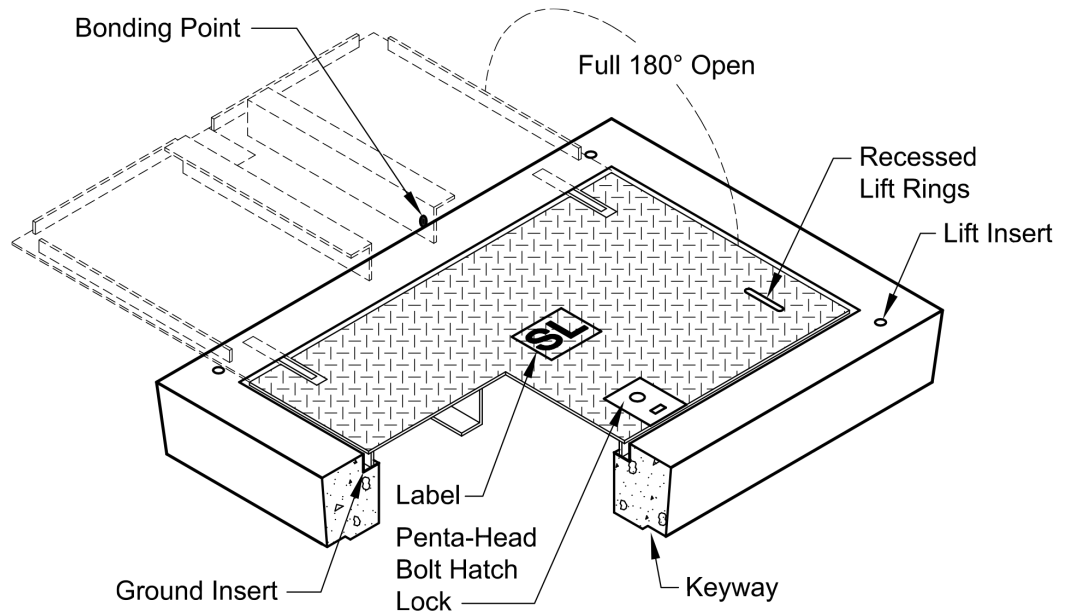
Cover shall be of configuration as shown in Figure 5.

- Cover dimensions shall be 32-in wide by 44-in long by 6-in deep.
- Covers shall have a 3/4-in lift insert at each corner on the top.
- Caps shall be provided to cover the lift inserts.
- Cover shall have a keyway to ensure a tight fit.
- A 1/4 in diameter ground insert shall be embedded in the cover on the hinged hatch side for bonding the frame.

The hatch shall have the following:

- Steel frame securely anchored in the concrete
- H20 rating
- Recessed lift handles
- One handle located on each of the short ends of the hatch
- 5/8-in bonding point hole on support bar for grounding hatch
- Hatch-locking mechanism with Penta-head bolt
- Label (SCL, SL, or SL/SDOT), according to Table 5.

**Figure 5. Cover with Slip-Resistant Steel Hatch**



**Table 5. Hatch Label**

Stock No.	Label
013184	SCL
013185	SL
013484	SL/SDOT

**6. Assemblies**

Handhole assemblies consist of a handhole base and a cover with metal hatch. All handhole assemblies use the same size cover.

**Table 6. Materials for 231 and 233 Handhole Assemblies**

Fig #	Stock No.	Assembly Description	Quantity				
4.1	013180	231 handhole base with cover, "SCL"					
4.1	013181	231 handhole base with cover, "SL"					
4.2	720388	233 handhole base with cover, "SCL"					
4.2	013179	233 handhole base with cover, "SL"					
4.2	013485	233 handhole base with cover, "SL/SDOT"					
	Stock No.	Material Description					
	013182	Base, 231 handhole	-	-	-	1	1
	013183	Base 233 handhole	1	1	1	-	-
	013184	Cover with hatch, "SCL"	-	-	1	-	1
	013185	Cover with hatch "SL"	-	1	-	1	-
	013484	Cover with hatch, "SL/SDOT"	1	-	-	-	-

**7. Issuance**

Unit: EA

**8. Approved Manufacturers**

Stock No.	Description	OldCastle Precast/ Utility Vault.	H2 Pre-Cast Inc.
013182	231 Handhole base	23R-12	VR233-12
013183	233 Handhole base	233-LA Base	VB233-SCL
013184	<b>Cover</b> , with hatch, "SCL"	23-2436F Cover w/ ID Marker "SCL"-3150029	VL233-2436-SCL
013185	<b>Cover</b> with hatch, "SL"	23-2436F Cover w/ ID Marker "SL"-3150028	VL233-2436-SL
013484	<b>Cover</b> with hatch, "SL/SDOT"	23-2436F Cover w/ ID Marker "SL/SDOT"	VL233-2436-SL/SDOT
013180	<b>231 handhole</b> base with cover, "SCL"	Type 3 Handhole-SCL-"SCL"-3150029	TYPE 3 HANDHOLE-W/2436-"SCL"
013181	<b>231 handhole</b> base with cover, "SL"	Type 3 Handhole-SCL-3150028	TYPE 3 HANDHOLE-W/2436-"SL"
720388	<b>233 handhole</b> base with cover, "SCL"	233 Handhole-SCL-"SCL"-3150029	233 HANDHOLE-W/2436-"SCL"
013179	<b>233 handhole</b> base with cover, "SL"	233 Handhole-SCL-"SL"-3150028	233 HANDHOLE-W/2436-"SL"
013485	<b>233 handhole</b> base with cover, "SL/SDOT"	233 Handhole-SCL-"SL/SDOT"	233 HANDHOLE-W/2436-"SL/SDOT"



## 9. References

**SCL Material Standard 7203.01**; "Precast Reinforced Concrete Handholes, General Requirements"

---

## 10. Sources

**Detter, Chris**; SCL Distribution Engineer and subject matter expert for 7203.08

**Ng, Sharon**; SCL Civil Engineer and subject matter expert for 7203.08

**Wang, Quan**; SCL Standards Engineer and subject matter expert for 7203.08

## Type 1 and Type 2 Open Bottom Handhole, Precast, Secondary and Streetlight



### 1. Scope

This standard covers the requirements for precast secondary handholes, streetlight handholes, handhole stacking risers, and handhole covers.

Stock No.	Description
012945	Type 1 handhole, with frame and cover labeled "S/L"
720391	Type 2 handhole, with frame and cover, "SCL"
013178	Type 2 handhole, with frame and cover, "S/L"
012978	Type 2 handhole, with frame and no cover
720402	Type 2 handhole stacking riser, without frame or cover
012660	Type 2 handhole cover, labeled "SCL"
012979	Type 2 handhole cover, labeled "S/L"

### 2. Application

Handhole assemblies are used to construct the means to allow connections to be made for secondary service and streetlight located on pedestrian sidewalks.

H-20 rated frames and covers are for use in pedestrian sidewalks where an occasional car or light truck may inadvertently traverse, or side streets that see only light truck traffic.

Standards Coordinator  
Quan Wang

Standards Supervisor  
John Shipek

Unit Director  
Andrew Strong

### 3. Industry Standards

All handholes shall meet the applicable requirements of the following industry standards:

**City of Seattle Standard Plan 550a**; “Handholes”; Public Utilities

**WSDOT Standard Plan J-40.10-00**; “Locking Lid Standard. Junction Box Types 1 & 2;”  
Washington State Department of Transportation

**ASTM A123/A123M - 08**; “Standard Specification for Zinc (Hot-Dip Galvanized) Coatings  
on Iron and Steel Products;” ASTM

**ASTM A185/A185 - 07**; “Standard Specification for Steel Welded Wire Reinforcement,  
Plain, for Concrete;” ASTM

**ASTM A615/A615M - 09b**; “Standard Specification for Deformed and Plain Carbon-Steel  
Bars for Concrete Reinforcement;” ASTM

**ASTM C39 / C39M - 12**; “Standard Test Method for Compressive Strength of Cylindrical  
Concrete Specimens;” ASTM

**ASTM C478 - 11**; “Standard Specification for Precast Reinforced Concrete Manhole  
Sections;” ASTM

**ASTM C857 - 12a**; “Standard Practice for Minimum Structural Design Loading for  
Underground Precast Concrete Utility Structures;” ASTM”

**ASTM C858 - 10e1**; “Standard Specification for Underground Precast Concrete Utility  
Structures;” ASTM

---

### 4. Conflict

Where conflict exists, the following order of precedence shall apply:

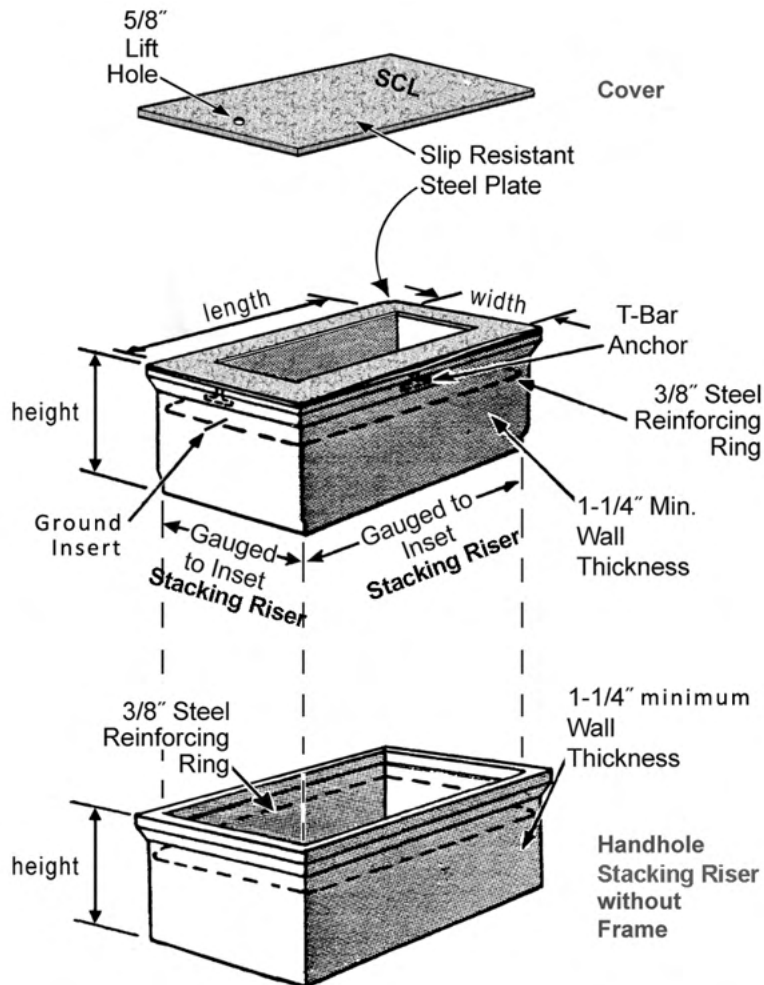
- Seattle City Light Purchase Order (PO)
- Seattle City Light General Terms and Conditions
- This material standard
- Other industry standards

**5. Construction**

The handhole shall meet Washington State Department of Transportation Standard Plan J-40.10 with the following clarifications.

Stock No.	Item	Type	Dimensions, nominal (in)				Cover Label
			Inside Length	Inside Width	Outside Length	Outside Width	
012945	Handhole with frame	1	19	14	—	—	—
	Cover	1	—	—	17	13	“SL”
720391	Handhole with frame	2	28	17	—	—	—
	Cover	2	—	—	26-5/8	16-1/2	“SCL”
013178	Handhole, with frame	2	28	17	—	—	—
	Cover	2	—	—	26-5/8	16-1/2	“SL”
012978	Handhole with frame	2	28	17	—	—	—
720402	Stacking riser	2	—	—	28	17	—
012660	Cover only	2	—	—	26-5/8	16-1/2	“SCL”
012979	Cover only	2	—	—	26-5/8	16-1/2	“SL”

**Figure 5. Handhole**



### 5.1 Precast Handhole

Precast secondary and streetlight handholes shall be of the general configuration shown, in accordance with City of Seattle Standard Plan 550a.

Handhole shall be designed to nest, with an easy, snug fit to increase the depth of the handhole when necessary.

Handhole shall be sound and free of cracks.

### 5.2 Concrete

The handhole shall be cast of concrete meeting a minimum strength of 4000 psi after 28 days.

### 5.3 Cover Plate

The cover plate shall adhere to the following requirements:

- The cover shall comply with City of Seattle Standard Plan No. 550a.
- The cover shall be 5/16-in (nominal) in thickness or other design pre-approved by Seattle City Light.
- The cover shall be at least H-20 rated.
- The cover shall have 1/16-in to 1/8-in clearance on each edge within the frame after galvanizing.

### 5.4 Frame

The frame shall adhere to the following requirements:

- The frame shall comply with City of Seattle Standard Plan No. 550a.
- The steel frame shall be securely anchored in the concrete.
- The frame shall have a ground point, which the copper braid from the cover may be attached.

### 5.5 Non Slip Surface

The cover and frame shall have a non-slip surface with the following properties:

- Slip resistant surface shall be coated with SlipNOT® Grade 3-coarse by W.S. Molnar Company, TH604 by Thermion, or have minimum coefficient of friction of 0.8.
- Bond strength shall be to the plate of 4000 psi or greater.
- Surface hardness shall be 55 minimum on the Rockwell "C" scale.
- The cover shall be identified on the underside with the type of surface ("S3" for SlipNOT® 3) and the year of manufacture. Example: "S3 2005." The identification shall be bead-welded or clearly stamped into a metal surface on the underside of each lid, or labeled with an adhesive metallic foil-backed label.

### 5.6 Grounding

A 4-ft length of copper braid, equivalent to a #8 AWG THNW or THHW copper wire, shall be secured from the handhole cover.

All handholes shall have a 5/16-in ground insert or a ground pad on the interior wall.

### 5.7 Labeling

Handhole covers shall be labeled "SCL" for secondary distribution service or "SL" for streetlight.

Label letters shall be affixed to the handhole cover by welding, engraving, or label plate in such a manner as to avoid being a tripping hazard.

## 5.8 Lock

The cover shall have a Penta-head bolt locking device to prevent easy removal by unauthorized persons.

## 5.9 Galvanizing

The frame, cover, label plate, and lettering shall be hot-dipped galvanized after fabrication in accordance with ASTM A123M.

---

## 6. Documentation

### 6.1 General

Documentation shall be in English and use customary inch-pound units.

Documentation shall use common industry terminology and well-understood abbreviations.

### 6.2 Technical Information

Upon request, the supplier shall provide the following technical information:

- Manufacturer name
- Manufacturing plant locations
- Product shop drawing

Technical information shall be presented in a clear and consolidated manner for ease of review.

---

## 7. Issuance

EA

---

## 8. Approved Manufacturers

Stock No.	Manufacturers	Catalog Numbers
012945	H2-Pre-Cast Inc	WDOT Type 1 Box with Cover – Galvanized, Non-Slip, "SL"
720391	"	WDOT Type 2 Box with Cover – Galvanized, Non-Slip, "SCL"
013178	"	WDOT Type 2 Box with Cover – Galvanized, Non-Slip, "SL"
012978	"	WDOT Type 2 Box - Galvanized
720402	"	WDOT Type 2 riser
012660	"	WDOT Type 2 Cover - Galvanized, Non-Slip, "SCL"
012979	"	WDOT Type 2 Cover - Galvanized, Non-Slip, "SL"

---

## 9. Sources

**9-34.6; Standard Specifications** for Road, Bridge and Municipal Construction; City of Seattle; Public Utilities

**Smalley, Edward**; SCL Engineer, Streetlights, and subject matter expert for 7203.10

**Wang, Quan**; SCL Standards Engineer, originator and subject matter expert for 7203.10

## Handhole, Secondary, Composite Fiberglass, Polymer Concrete



### 1. Scope

This standard covers requirement for composite fiberglass reinforced polymer and polymer concrete handholes.

This standard applies to the following Seattle City Light stock numbers:

Stock No.	Description
720393	17" x 30" x 12" handhole box
720397	17" x 30" x 3/4" cover
720394	24" x 36" x 18" handhole box
720399	24" x 36" x 2" cover

### 2. Application

Composite fiberglass polymer handholes and polymer concrete handholes are non-conductive, non-flammable and corrosion resistant underground enclosures used to house connections for secondary service and streetlight (SL).

Tier 5 enclosures are only to be used in planting strips or landscaped areas, or for pedestrian traffic.

Polymer handholes are not intended for use in constant traffic areas.

Handhole boxes may be stacked to achieve proper service termination installation depth of 24 inches or 36 inches as required in Construction Standard 1561.07.

Standards Coordinator  
Quan Wang

Standards Supervisor  
John Shipek

Unit Director  
Andrew Strong

### 3. Industry Standards

Composite fiberglass polymer and polymer concrete handholes shall meet the following industry standards:

**ANSI/SCTE 77 - 2010**; Specification for Underground Enclosure Integrity

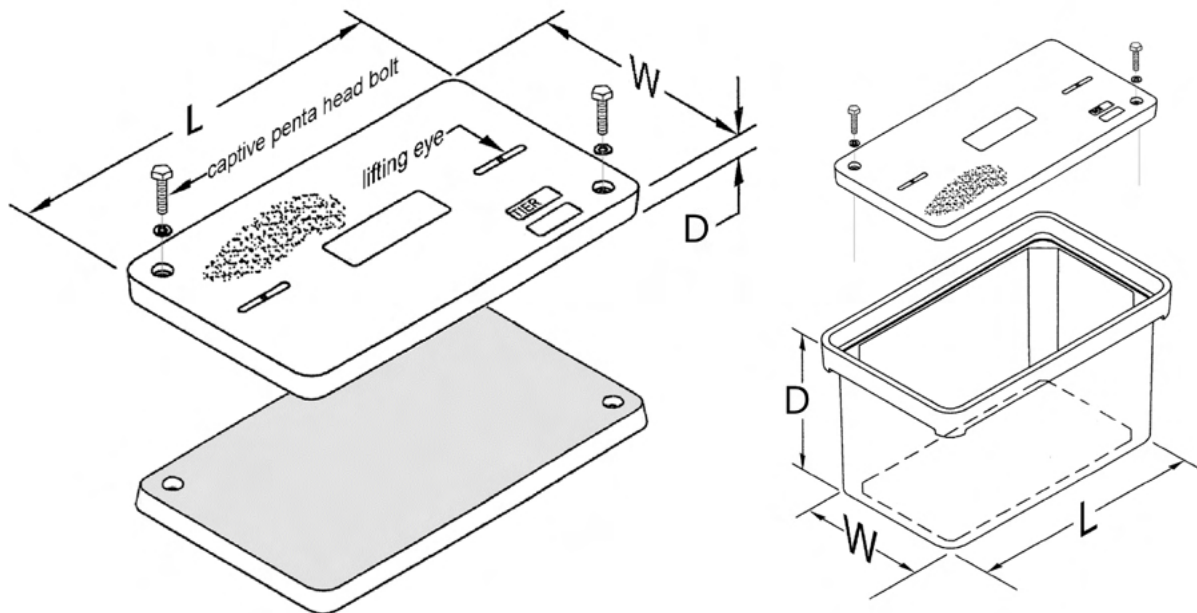
**ASTM C857 - 2016**; Standard Practice for Minimum Structural Design Loading for Underground Precast Concrete Utility Structures

### 4. General Requirements

Handhole and cover shall have the following attributes:

- Made of fiberglass reinforced polymer or polymer concrete
- Gray in color
- Non-conductive
- Non-flammable
- Corrosion resistant
- Design load rating as shown in Table 4
- Chemical resistance (sunlight exposure, water absorption, and flammability) of polymer handholes and covers according to ANSI/SCTE 77 2010, Section 6
- Nominal dimensions as shown in Table 4 and Figure 4

**Figure 4. Polymer Handhole and Cover Dimensions**





**Table 4. Handhole and Cover Dimensions**

Stock No.	720393	720397	720394	720399
<b>Type</b>				
<b>Description</b>	Handhole Box	Cover	Handhole Box	Cover
<b>Dimensions, Inside, Nominal (in)</b>				
<b>Length (L)</b>	30	30	36	36
<b>Width (W)</b>	17	17	24	24
<b>Height/Thickness (D)</b>	12	3/4	18	2
<b>Cover Label</b>	Seattle City Light	–	–	Seattle City Light
<b>Design Load</b>				
<b>Tier</b>	5	5	22	8
<b>Vertical, minimum (lb)</b>	5000	5000	22,500	8000
<b>Test Load</b>				
<b>Vertical, nominal (lb)</b>	7500	7500	33,750	12,000

**4.1 Box**

Handhole box shall be:

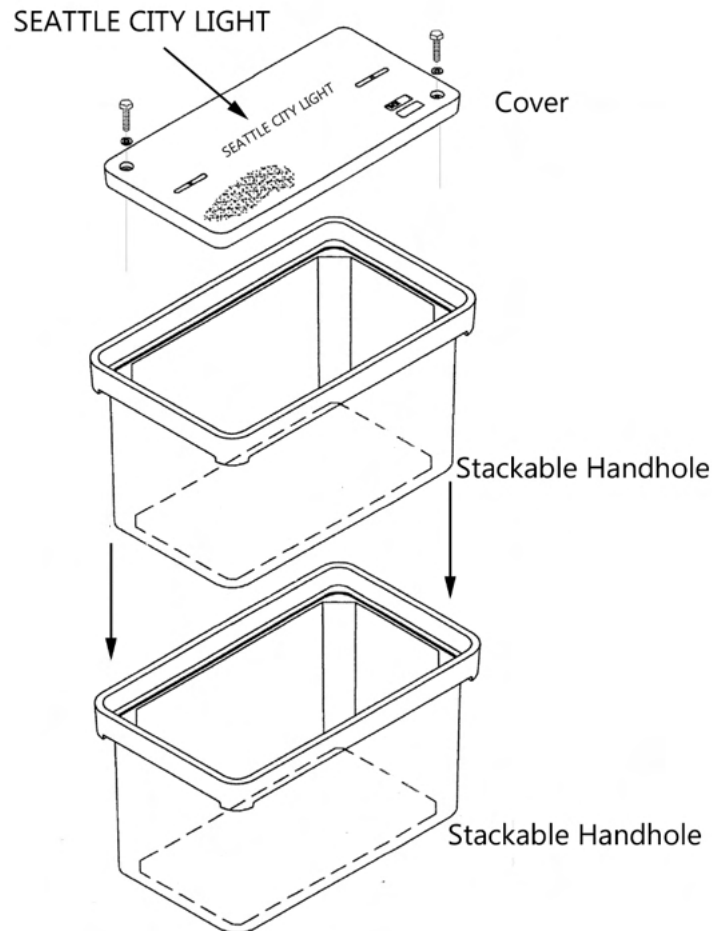
- Bottomless without any knockouts or mouseholes
- Straight wall and stackable
- Designed to nest with the handholes for a snug fit

**4.2 Cover**

Cover shall:

- Require the use of tools to open, to avoid easy removal by unauthorized persons
- Be skid resistant with a minimum coefficient of friction of 0.5 percent
- Have recessed bolt holes such that the bolt head will not protrude above the cover surface
- Include two, stainless steel, captive, Penta-head bolts (1/2 inches – 13 UNC) to attach cover to handhole
- Have 1/16-inch to 1/8-inch clearance on each edge of the box
- Be marked with the ANSI load rating (Tier 5 or 8)
- Have “SEATTLE CITY LIGHT” embedded on the top surface as shown in Figure 4.2

**Figure 4.2. Polymer Handhole and Cover**



---

## 5. Marking

Polymer handholes shall be clearly and indelibly marked in accordance with NEC2008.

Marking shall include but not be limited to:

- Manufacturer name
- Year of manufacture
- Product identification number
- ANSI load rating

---

## 6. Packaging

Handholes and cover shall be packaged in a way that allows the product to withstand normal shipping and installation practices without chipping, cracking, or structural damage.

Individual packages shall be legibly marked with:

- Manufacturer name
- Manufacturer catalog number
- Product description

- Seattle City Light stock number

Shipping containers shall be legibly marked with:

- Seattle City Light purchase order number
- Seattle City Light stock number

---

## 7. Issuance

Stock Unit: EA

---

## 8. Approved Manufacturers

Stock No.	Approved Manufacturers		
	Oldcastle-Duravault	Quazite	Armorcast
720393	FRP1730-12STB	PC1730BA12	A6001761
720397	FRP1730P1-T15/20K Seattle City Light - Penta Bolt	PC1730CA00-OL	A6001762-SEATTLE
720394	FRP2436-18STB	PG2436BA18	A6001974PCX18
720399	FRP2436P1-T15/20K Seattle City Light - Penta Bolt	PG2436CA00-OL	A6001975-SEATTLE

---

## 9. References

**National Electrical Code (NEC) 2008**; "Article 314.30"

**Wang, Quan**; SCL Standards Engineer and subject matter expert for 7203.12  
(quan.wang@seattle.gov)

**Western Underground Committee Guide 3.6**; "Non-Concrete Enclosures"

---

## 10. Sources

**Standard Plan No. 550a**; City of Seattle Standard Plans and Specifications, 2010

**SCL Material Standard 7203.10**; "Handhole, 17" x 28" Precast, Secondary"

**SCL Material Standard 7203.20**; "Handhole, Secondary, Composite Fiberglass, Reinforced Plastic Type"

**Precast Reinforced Concrete Structures, General**



**1. Table of Contents**

2. Scope .....	2
3. Application .....	2
4. Definitions .....	2
5. Industry Standards .....	2
6. Conflict .....	3
7. Order Information .....	3
8. Requirements .....	4
8.1 Reinforced Concrete .....	4
8.2 Structural Design .....	4
8.3 Grounding .....	5
8.4 Knockouts and Vault Openings .....	6
8.5 Lifting Methods .....	6
8.6 Vault Accessories .....	6
8.7 Metal Doors and Access Cover Plates .....	7
8.8 Non-Slip Surfaces .....	8
9. Marking .....	8
10. Causes for Rejection .....	8
11. Product Approval .....	9
12. Issuance .....	9
13. Approved Manufacturers .....	9
14. References .....	9
15. Sources .....	9

Standards Coordinator  
 Quan Wang

Standards Supervisor  
 John Shipek

Unit Director  
 Andrew Strong

## 2. Scope

This standard covers the general requirements for precast reinforced concrete structures used at Seattle City Light (SCL).

This standard applies to the following SCL reinforced concrete products:

- Vaults
- Vault cover
- Pads

Specific requirements shall be according to the detailed material standards and purchase orders issued subsequent to competitive solicitations.

This standard does not apply to panel vaults.

---

## 3. Application

Precast concrete structures are used to construct the underground electric system.

Precast concrete structures may be used to house equipment, cables, service connections and splices for the distribution system.

For non-network vaults, a fixed ladder is required when the vault floor exceeds 12 feet 6 inches below finished grade. For network vaults, a fixed ladder is required when the vault floor exceeds 14 feet 5 inches below finished grade.

---

## 4. Definitions

**Vault (as defined by NESC)** - A structurally solid enclosure, (including all sides, top, and bottom), above or below ground, where entry is limited to personnel qualified to install, maintain, operate, or inspect the equipment or cable enclosed. The enclosure may have openings for ventilation, personnel access, cable entrance, and other openings required for operation of equipment in the vault.

**Vault (as defined by SCL)** - An enclosure that is used for primary service. Enclosures 444 or larger.

**Ring Vault (as defined by SCL)** - A vault that is composed of multi-sections, i.e. base, mid-section, and a top section. These vaults may also have various risers to achieve the proper height and access openings. Enclosures 818 and 814.

**Concrete Encased Electrode (as defined by NESC)** - A metallic wire, rod, or structural shape, meeting Rule 93E5 and encased in concrete, that is not insulated from direct contact with earth, shall constitute an acceptable ground electrode. The concrete depth below grade shall be not less than 1 foot, and a depth of 2.5 feet is recommended. Wire shall be no smaller than AWG No. 4 if copper, or 3/8-inch diameter or AWG No. 1/0 if steel. It shall be not less than 20 feet long, and shall remain entirely within the concrete except for the external connection. The conductor should be run as straight as practical.

---

## 5. Industry Standards

Concrete structures shall meet the applicable requirements of the following industry standards:

**ACI 318-11**, "Building Code Requirements for Structural Concrete and Commentary"

**ANSI/AWS D1.4/D1.4M-11**, "Structural Welding Code – Reinforced Steel"

**ASTM A123/A123M-08**, "Standard Specification for Zinc (Hot-Dip Galvanized) Coatings on Iron and Steel Products;" ASTM

- ASTM A185/A185M-07**, “Standard Specification for Steel Welded Wire Reinforcement, Plain, for Concrete”
- ASTM A497/A497M-07**, “Standard Specification for Steel Welded Wire Reinforcement, Deformed, for Concrete”
- ASTM A615/A615M-09b**, “Standard Specification for Deformed and Plain Carbon-Steel Bars for Concrete Reinforcement”
- ASTM A706/A706M-09b**, “Standard Specification for Low-Alloy Deformed and Plain Bars for Concrete Reinforcement”
- ASTM C39/C39M-10**, “Standard Test Method for Compressive Strength of Cylindrical Concrete Specimens”
- ASTM C150/C150M-12**, “Standard Specification for Portland Cement”
- ASTM C478-09**, “Standard Specification for Precast Reinforced Concrete Manhole Sections”
- ASTM C857-11**, “Standard Practice for Minimum Structural Design Loading for Underground Precast Concrete Utility Structures”
- ASTM C858-10e1**, “Standard Specification for Underground Precast Concrete Utility Structures”
- National Electrical Safety Code (NEC) C2-2012, Rule 094B6**;  
“Concrete-Encased Electrodes”
- 

## 6. Conflict

Where conflict exists, the following order of precedence shall apply:

1. SCL purchase order
  2. SCL General Terms and Conditions
  3. This standard
  4. SCL detailed material standards
  5. ASTM standards
  6. Other industry standards
- 

## 7. Purchase Order Information

Purchase orders will include the following minimum information:

- Vault size and description
- SCL general material standard number including revision date
- SCL detailed material standard number including revision date
- SCL stock number
- Total order quantity
- Price
- Delivery date
- Ladder requirement

Design changes shall require the prior written approval of an SCL Org 321 Standards Engineer.

## 8. Requirements

### 8.1 Reinforced Concrete

Minimum compressive strength of concrete shall not be less than 4,500 pounds per square inch in 28 days as determined by the ASTM Method C39.

Cement shall conform to ASTM C150.

No additives containing calcium chloride or any other material that will produce corrosive ions shall be used in the concrete.

Welded wire fabric shall conform to ASTM A185 or A497.

Steel Reinforcing Bars shall conform to ASTM A615, Grade 60 or ASTM A706, Grade 60.

Welding of reinforcing steel shall conform to the Structural Welding Code, Reinforcing Steel (AWS D1.4) of the American Welding Society.

The concrete cover (measured from the surface of the concrete to the outside surface of the reinforcement) for reinforcement shall be 1-1/2 inches minimum for main reinforcing bars and 3/4 inch for stirrups and ties.

The concrete finish shall be free of rock pockets and honeycombed areas.

The interior walls, ceiling and exterior surfaces exposed shall be smooth.

Rock pockets over 3/8 inch deep and other imperfections on all surfaces shall be patched and troweled to match the surrounding surface.

### 8.2 Structural Design

Structural design of the precast vault shall conform to ACI 318 and ASTM C857 with the following clarifications:

- Reinforced concrete vaults shall be designed and constructed to be watertight.
- Top of vault shall be assumed to be at a minimum of 2 ft and maximum (unless noted on drawings) 5 ft below grade.
- Live Load: AASHTO HS-20 truck, P=16 kips. Traffic can approach the structure from any direction.
- 30% live load impact load factor for soil cover less than or equal to 3 ft.
- No live load surcharge for soil cover greater than 8 ft.
- Soil density shall be 120 lb force per cubic ft.
- 40 lb force per cubic ft Equivalent Fluid Pressure Lateral Soil Pressure Above Water Table.
- 80 pounds force per cubic foot Equivalent Fluid Pressure Lateral Soil Pressure Below Water Table.
- 80 pounds per square ft Live Load Surcharge.
- Buoyancy: Vault weight (without equipment) plus weight of soil cover shall be greater than 1.1 times the hydrostatic uplift force on the base of the vault. It cannot rely on skin frictional resistance between backfill and vault wall surfaces. If the gravity load is insufficient, then the vault shall be designed with restraints to withstand the buoyant force. The restraint design shall be submitted for review and approval.
- The groundwater table shall be assumed to be 5 ft below grade.

### 8.3 Grounding

#### 8.3.1 Electrodes

Concrete-encased electrodes shall comply with NESC 094B6.

Electrodes shall be:

- No smaller than #4 AWG if copper or or 3/8-inch diameter (1/0) if steel.
- No less than 20 ft long and shall remain entirely within the concrete except for the external connections.
- Installed as straight as possible.
- Encased in a minimum of 1-1/2 inches of concrete.
- Positioned a minimum of 2-1/2 ft below the top of the vault.

#### 8.3.2 Ground Insert Connector

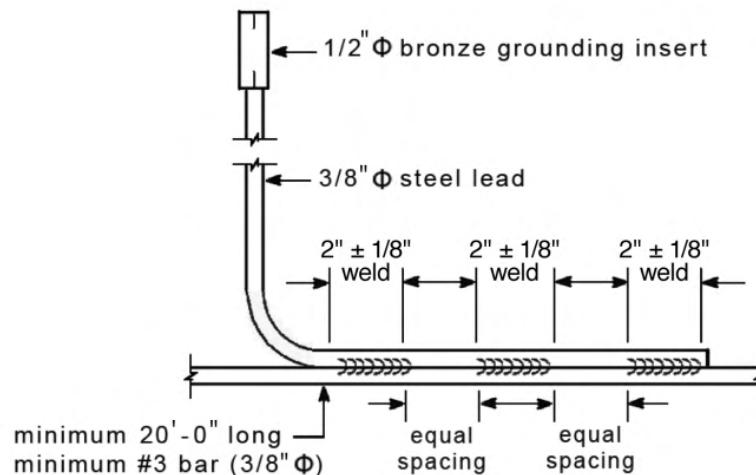
Ground insert connectors shall be installed flush (neither recessed nor protruding) with the vault wall.

Bronze inserts shall be tapped for 1/2-13 UNC bolts, and located on two opposite walls.

The nominal thread depth of the bronze insert shall be 1-1/8 inches.

The lead rod, a 3/8-inch steel or bronze rod, shall be connected to the ground electrode with arc weld or Cadweld (exothermic connection) at a minimum of three points as shown in Figure 8.3.2.

**Figure 8.3.2. Lead Rod and Concrete-Encased Electrode Weld Details**



Inserts shall be plugged to prevent contamination from entering.

Insert faces shall be exposed and marked prior to pick-up or delivery.

On multi sectioned vaults (3 or more sections):

- The inserts shall be aligned vertically.
- Only the middle section will have the inserts that face inside and outside of the vault.
- All other inserts in the vault shall be placed in accordance with the drawing of the specific vaults on manufacturer's specifications and approved by SCL.



## **8.4 Knockouts and Vault Openings**

### **8.4.1 Vault Openings**

Vaults 7 ft x 12 ft (inside dimensions) and larger shall have two 42-in diameter access entries, unless specified otherwise in the detailed material standards.

All vaults shall have cable knockouts located in each lower corner of the enclosure according to the manufacturer's standard and SCL's requirements.

Knockout and duct openings shall be beveled on the exterior surface.

Each enclosure with a floor shall have a ground-rod knockout at two corners of the base of the enclosure. Size, shape, quantity and location of knockouts shall be as specified in the detailed material standards.

### **8.4.2 Duct Bank Knockout Threaded Inserts**

For 712 and larger vaults, provide four minimum 1/2-in diameter ferrule-threaded insert at perimeter of each duct bank knockout. These threaded inserts are to allow the duct bank rebar to dowel into the vault wall.

Threaded inserts shall be spaced 12 in (nominal) apart along the height of each knockout panel.

## **8.5 Lifting Methods**

Lifting provisions shall be provided per manufacturer's and SCL requirements.

### **8.5.1 Covers**

All vault covers, pads or slabs, or risers weighing less than 9,000 pounds shall have 3/4-in lifting inserts on each corner of the top surface, or as described in the detailed material standards.

### **8.5.2 Burke Fittings**

All vault covers or structures over 9,000 pounds shall have either a 2-ton or a 4-ton Burke fitting placed in each corner of the top surface or on the four walls, as described in the detailed material standards.

### **8.5.3 Lifting Inserts**

Lifting inserts shall be provided as shown in the detailed material standards.

All metal lifting devices cast into the internal or external surfaces of vaults for handling purpose shall be hot-dipped galvanized or made from stainless steel.

## **8.6 Vault Accessories**

Structural components shall be provided with vault section components. Structural components include, but are not limited to, grout, seals, or mastics, and joint hardware.

Items in the following sections to be included with all vaults.

### **8.6.1 Cable Pulling Irons**

Vaults larger than 577 shall have 7/8-in diameter cable pulling irons mounted on each corner of the vault and be suitable as anchors for cable pulling operations.

7/8-in diameter cable pulling iron mounts shall withstand 10 kips maximum working tension and 20 kips ultimate strength.

577 and smaller vaults shall have 1/2-in diameter cable pulling irons mounted on each corner of the vault and be suitable as anchors for cable pulling operations.

1/2-in diameter cable pulling iron mounts shall withstand 5 kips maximum working tension and 10 kips ultimate strength.

Pulling irons shall be stainless steel or hot dipped galvanized steel.

The maximum working tension for pulling irons shall be stenciled on the wall surface near two of the roof pulling irons.

Burke lifting devices are not suitable for cable pulling purposes.

### **8.6.2 “C” Channels**

Vault shall be provided with a cast-in-place channel.

“C” channels shall be included on each of the four interior walls unless stated otherwise in the detailed material standards.

“C” channel strut size shall be 1-5/8 in by 13/16 in for the following vaults: 504, 507, 644, 577, 687, and 5106, unless stated otherwise in the detailed material standards.

“C” channel strut size for vaults sized 712 and larger shall be 1-5/8 in by 1-5/8 in or 1-5/8 in by 1-3/8 in, unless stated otherwise in the detailed material standards.

### **8.6.3 Drainage and Sump**

All vaults shall have a drain sump.

Vaults that are 7 ft x 12 ft (inside dimensions) and larger shall have a rectangular sump at one end wall. Sump shall be equipped with galvanized grating.

Vaults smaller than 7 ft x 12 ft shall have a circular sump with cover located near the center of the vault.

The floor shall be sloped to drain to the sump in 577 or larger vaults.

### **8.6.4 Ladders**

If a ladder is required (see Section 3):

- Ladders shall be corrosion resistant.
- Ladders shall be made according to SCL Drawing D-28304, “Retractable Ladder, Vault and Manhole Access.”

### **8.6.5 Joint Sealant**

Vault sections shall be provided with butyl rubber joint sealant material or gasket mastic to be used between vault keyways and sections, including hatch riser rings.

## **8.7 Metal Doors, Access Cover Plates, and Hatches**

All lids, hatches, and frames shall be provided with a grounding site.

### **8.7.1 Frames and Hatches**

All frames and hatch covers for shall be designed for at least 20.8 kips wheel load (HS20 + 30% impact) applied in any direction.

All frames and lids shall have a non-slip surface.

The 42-inch round cover and frames shall also comply with requirements in SCL Material Standard 7204.70, Frames and Covers, 42-in Round, Iron.

### 8.7.2 Hatches

All hatches shall:

- Include one 5/8-in diameter bonding hole located in an underside bearing bar, approximately centered in the door, and 2-1/2 to 3-1/2 in from the hinged edge.
- Be designed for at least 20.8 kips wheel loading (H20 + 30% impact).
- Be hinged and shall fully open to 180 degrees.
- Not exceed 65 pounds equivalent lift.
- Have a non-slip surface.
- Have a locking mechanism, such as a Penta head bolt, to prevent unsolicited access. Locking mechanism shall not protrude above the door surface.

Aluminum hatches for 36-in x 36-in and 36-in x 72-in opening access shall be designed for at least 26 kips wheel loading (H25 + 30% impact or equivalent H30 + 8% impact).

All steel hatches and access cover plates shall be hot dipped galvanized in accordance with ASTM A123, unless otherwise approved in accordance with Section 8.1.

Square or rectangular doors shall open along the lengthwise of the access opening.

### 8.8 Non-Slip Surfaces

All non-slip surfaces shall have:

Minimum coefficient of friction	0.8
Bond strength to the plate	3000 psi or greater
Surface hardness	55 minimum on the Rockwell "C" scale
Non-slip coating	SlipNot Grade 3 or Thermion TH604

The type of non-slip surface and the year of manufacture shall be identified on the underside of the door (for example, "S3 2005" or "TH604 2016" for SlipNot or Thermion respectively). The identification shall be bead welded or clearly stamped into a metal surface on the underside of each lid, or labeled with an adhesive, metallic foil-backed label.

---

## 9. Marking

All lids and doors shall be permanently marked "Electric," in 3-inch high letters clearly visible on the top where distribution cables occupy the enclosure.

---

## 10. Causes for Rejection

Precast concrete vaults shall be manufactured in accordance with ASTM C858.

A vault may be rejected if it fails to conform to ASTM C858 construction and dimensional tolerances except for concrete cover over reinforcing shall not be less than listed above.

A vault may also be rejected if it does not meet SCL 7201.00, "Acceptance Criteria for the Installation of New Precast Concrete Distribution Facilities."

Corrections of minor defects shall meet the requirements of this material standard. Such work shall be done in accordance with SCL U2-6/NVH-20, "Inspection and Repair Procedures for Precast Vaults and Manholes."

Vaults shall be warranted for one year against design and manufacturing defects including those resulting from poor workmanship and materials.

## 11. Product Approval

Manufacturers interested in having their precast concrete vaults and accessories approved for purchase by SCL shall participate in the stepped process summarized below.

- Provide evidence of National Precast Concrete Association (NPCA) certification.
- Adhere to Quality Control Program in accordance with the NPCA plant certification.
- Provide product specifications and cut sheet review.
- Provide sample concrete enclosure field trial.
- Review and evaluate field trial.
- Conduct a prototype pulling iron test to demonstrate that the pulling iron could withstand 40 kips ultimate load without failure.
- Submit the certified report for the pulling iron test.
- Manufacturer shall have a local representative or agent who will provide technical support and authorized to allow returns and repairs to be conducted by SCL or contractors.

Manufacturers are encouraged to plan accordingly. The approval process can take up to six months to complete.

---

## 12. Issuance

EA

---

## 13. Approved Manufacturers

Approved manufacturers are identified in the detailed material standards.

---

## 14. References

**SCL Construction Guideline U2-6/NVH-20**; "Inspection and Repair Procedures for Precast Vaults and Manholes"

**SCL Drawing D-28304**; "Retractable Ladder, Vault and Manhole Access,"  
SCL Engineering internal document

**SCL Material Standard 7201.00**; "Acceptance Criteria for the Installation of New Precast Concrete Distribution Facilities"

**SCL Material Standard 7203.08**; "Handhole, 2 in x 3 in x 3 in Precast"

**SCL Material Standard 7203.10**; "Handhole, Precast, Secondary and Streetlight"

**SCL Material Standard 7204.70**; "Frames and Covers, 42-inch Round, Iron"

**National Electrical Safety Code (NESC)**; **C2-2012** Edition, Institute of Electrical and Electronics Engineers (IEEE) Inc., New York, NY, 2011

**Vault Standard Specifications**, Ng, Sharon, Seattle City Light internal publication

---

## 15. Sources

**Detter, Chris**; SCL Distribution Engineer and subject matter expert for 7203.21  
(chris.detter@seattle.gov)

**Ng, Sharon**; Senior Civil Engineer and subject matter expert for 7203.21  
(Sharon.ng@seattle.gov)

**Wang, Quan**; SCL Standards Engineer and subject matter expert for 7203.21;  
(quan.wang@seattle.gov)

## 444 Enclosures, Precast



### 1. Table of Contents

1. Table of Contents .....	1
2. Scope .....	1
3. Application .....	2
4. General Requirements .....	2
5. Component Requirements .....	2
5.1. Grounding and Bonding .....	2
5.2. Vault Base .....	2
5.3. Vault Cover .....	4
6. Vault Assemblies .....	5
7. Issuance .....	5
8. References .....	6
9. Approved Manufacturers .....	6

### 2. Scope

This standard covers the detailed requirements for 444 precast enclosures and components (vault base and cover with hatch). The basic components can be ordered separately, or they can be ordered as assembled enclosures with covers.

This standard applies to the following Seattle City Light Stock Numbers:

Stock Number	444 Enclosure Components
013093	<b>vault base</b> , standard 444
013094	<b>cover</b> , 4- by 4-foot with one 3-by 3-foot, non-slip, H-20, solid hatch-“SCL”
013095	<b>cover</b> , 4- by 4-foot with one 42-inch round, solid cover and frame, H-20
013157	<b>cover</b> , 4-foot, 4-inch by 4-foot, 7-inch with one 3- by 3-foot, non-slip, solid hatch, H-30-“SCL”
Stock Number	Assembled 444 Enclosures
013120	<b>444 enclosure</b> with 4- by 4-foot cover with one 3-foot by 3-foot, non-slip, H-20, solid hatch-“SCL”
013121	<b>444 enclosure</b> with 4- by 4-foot cover with one 42-inch round, solid cover and frame, H-20
013158	<b>444 enclosure</b> with 4-foot, 4-inch by 4-foot, 7-inch with one 3- by 3-foot, non-slip, solid hatch, H-30-“SCL”

standards coordinator	standards supervisor	unit director
 Quan Wang	 John Shipek	 Andrew Strong

**3. Application**

444 enclosures are intended for use in the construction of underground electric systems. The precast concrete structures may be used to house load break junction boxes, communications wires, or service connections and splices for the distribution system.

H20-rated 444 enclosures are not intended to be used in high density traffic locations.

A standard 444 enclosure typically consists of the 444 base (Stock No. 013093) and the 4-ft by 4-ft cover with one 3- by 3-ft non-slip, H-20 solid hatch (Stock No. 013094).

Due to different applications, the vault may need to be customized with a different entry opening.

Depending on the application for the enclosure selected, it can be defined as a handhole or a vault.

When Seattle City Light uses the 444 enclosure for primary service, the 444 enclosure will be designated as a vault. For non-primary service the 444 enclosure can typically be referred to as a handhole.

Steps for selecting the proper vault assembly for your application:

1. Select the appropriate vault base (one option for the 444 size)
2. Select vault cover (three options for the 444)

**4. General Requirements**

This detailed standard is to be used in conjunction with the latest revision of:

- City Light Material Standard 7203.21, "Precast Reinforced Concrete Structures – General"
- City Light Material Standard 7204.70, "Frames and Covers, 42-Inch Round, Iron"

**5. Component Requirements**

**5.1 Grounding**

Vault grounding shall comply with Material Standard 7203.21, Section 9, Grounding.

**5.2 Vault Base**

The SCL 444 vault base (Stock No. 013093) shall have an overall nominal dimension of 4-feet by 4-feet by 3-feet 6-inches high as shown in Table 5.2a and Figure 5.2.

Approximate base weight is 2,200 pounds.

**Table 5.2a, Standard 444 Vault Base Dimensions**

Stock Number	Nominal Dimensions, ft-in					
	Wall, Outside		Wall, Inside		Height	
	Length	Width	Length	Width	Outside	Inside
013093	4-0	4-0	3-4	3-4	3-8	3-1

**5. Component Requirements, continued**

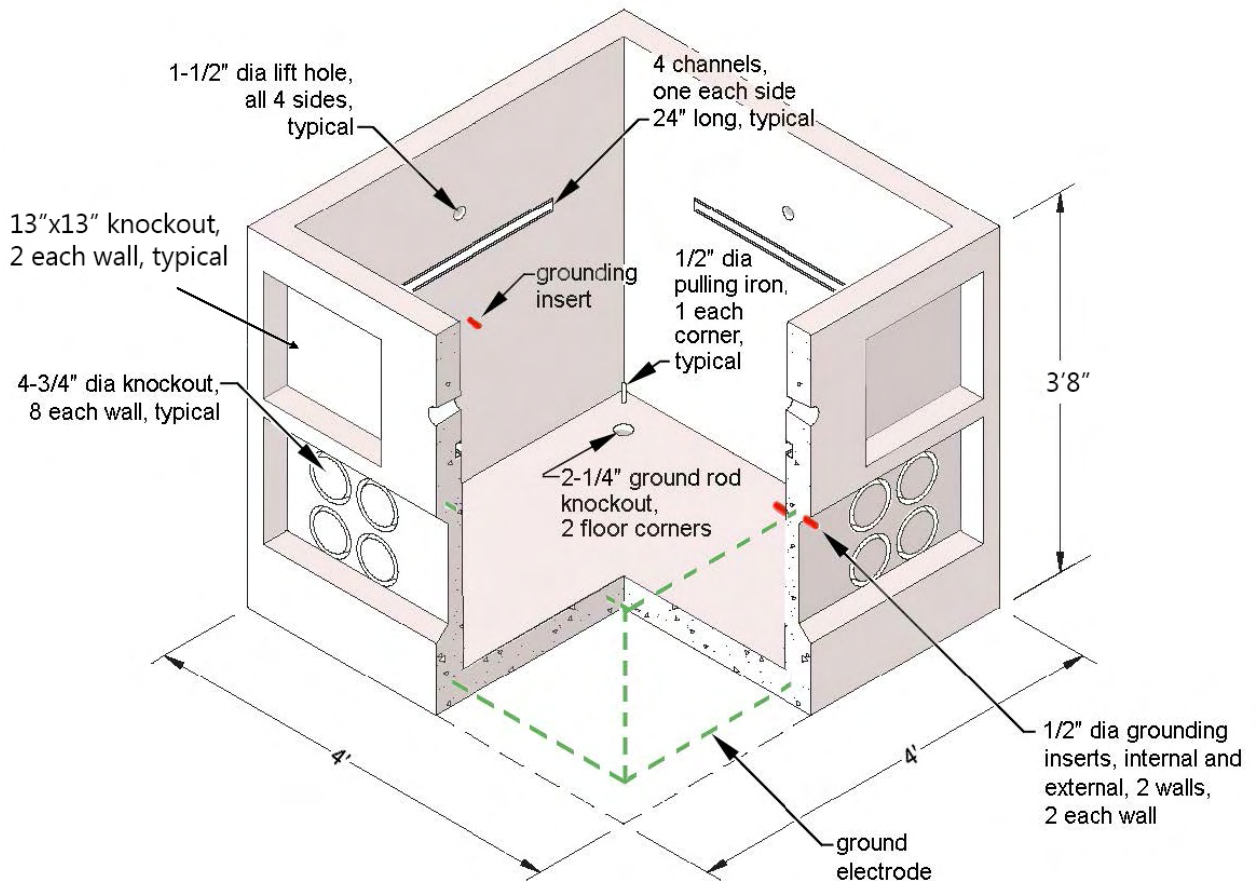
**5.2 Vault Base, continued**

**Table 5.2b, Vault Base Attributes**

All Standard 444 vault bases shall have the following features:

	Size, Nominal (in)	Location	Per Location	Total Number
<b>Knockouts</b>				
round	4-3/4 dia	all 4 walls, on bottom	8 ea side	32
ground rod	2 dia	2 corners of floor	1 ea	2
window	13 x 13	All 4 corners of upper wall	2 each per wall	8
<b>Channels</b>				
galvanized "C" channel, horizontal, embedded in walls	24 long	all walls, above all knockouts	1 ea side	4
<b>Pulling Irons</b>	1/2 dia	1 ea corner of floor (typical)	1 ea corner	4
<b>Lift Holes</b>	1-1/2 dia	4 walls, center of wall, above channel	1 ea side	4
<b>Ground Inserts, bronze</b>	1/2 dia	2 walls, opposite, internal and external	2 ea side	4
<b>Ladder</b>		not required		

**Figure 5.2, Standard 444 Vault Base** (dimensions shown are nominal values)



Seattle City Light  
**MATERIAL STANDARD**

**5. Component Requirements, continued**

**5.3 Vault Cover**

Covers shall have a nominal overall dimension of 4 feet by 4 feet. Thickness shall be 6 inches. Approximate vault cover weight is 650 pounds.

All covers shall have overall dimensions as shown in Table 5.3. Vault covers shall have a keyed form to match the base for proper assembly.

All covers shall have 3/4-inch diameter (nominal) lift inserts at each corner on the top, as shown in Figure 5.3a.

Caps shall be provided to cover the lift inserts.

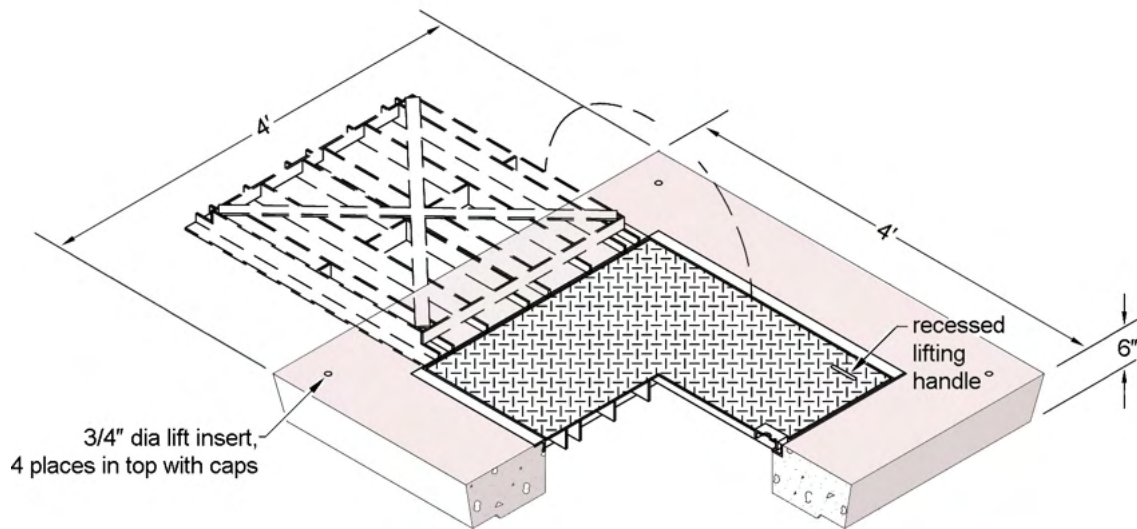
Covers with the 42-inch round cover shall include a 4-inch deep, round frame, as shown in Figure 5.3b. Note, the iron frame in the cover for round openings extends over the sides of the cover.

All hinged hatches shall open a full 180 degrees, or flat.

All hinged hatches shall include a grounding bracket on the bottom of the hatch for bonding and grounding.

**Figure 5.3a, 4-Foot Square Vault Cover with 3-Foot Square Hatch**

dimensions shown are nominal values



**Table 5.3, Vault Cover**

Stock Number	Cover Dimensions, Nominal, ft-in			Opening, in	Cover/Hatch
	Length	Width	Thickness		
013094	4-0	4-0	0-6	36 by 36, square	one 3- by 3-foot, non-slip, solid cover hatch, H-20
013095	4-0	4-0	0-6	38, dia, round	one 42-inch round, solid cover and frame, H-20
013157	4-4	4-7	0-6	36 by 36, square	one 36- by 36-inch, non-slip, solid cover hatch, H-30

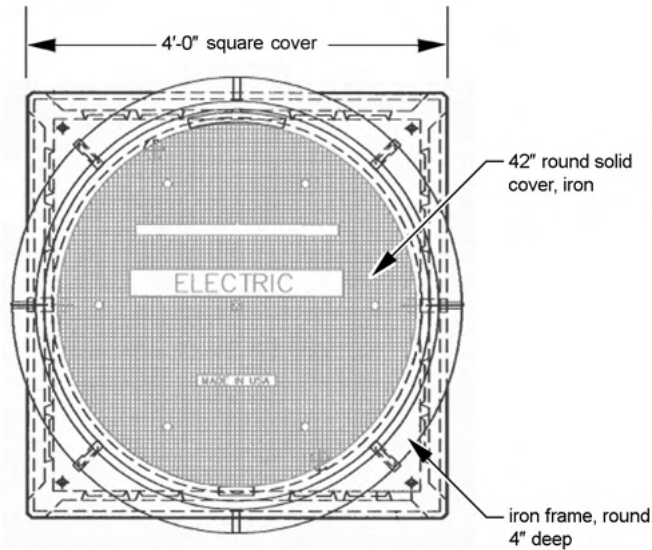


**5. Component Requirements, continued**

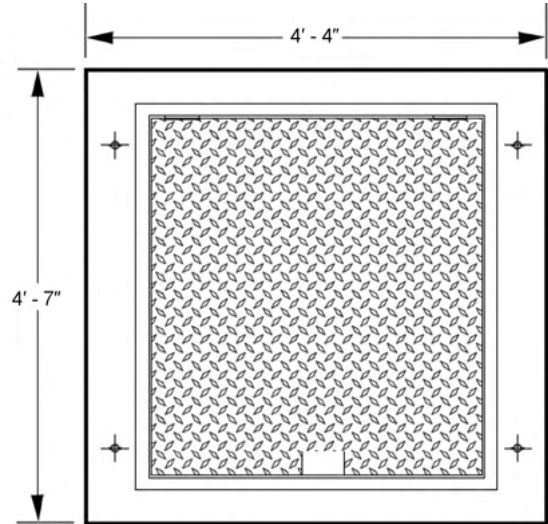
**5.3 Vault Cover, continued**

**4-Foot Square Cover**, dimensions shown are nominal values

**Figure 5.3b, Vault Cover with 42-Inch Round Cover**



**Figure 5.3c, Vault Cover with 36- by 36-Inch Hatch**



**6. 444 Enclosure Assemblies**

**Table 6. 444 Enclosure Components**

Assembled Enclosure Stock Number	Vault Base Stock Number	Vault Cover Stock Number	Hatch
013120	013093	013094	H-20 solid square hatch, 3- by 3-foot
013121	013093	013095	H-20 solid round, 42-inch
013158	013093	013157	H-30 solid square hatch, 3- by 3-foot

Refer to Tables 5.2a, 5.2b, and 5.3 for the various components included in each enclosure assembly.

**6.1 Assembly Options**

All enclosure assemblies use the same vault base. Depending on the type of hatch desired, the vault base may be paired with a different cover size with appropriate hatch, as shown in Table 6.

**6.2 Assembly Requirements**

All solid hatches have non-slip surfaces. Each section of the vault components shall have keyways for proper assembly.

**7. Issuance**

Unit: EA

**8. Approved Manufacturers**

Stock No.	Description	Manufacturer Catalog No.	
		Oldcastle/Utility Vault	H2 Precast
013093	<b>standard base</b>	444-LA Base w/ Iron and GRD In and Out	444 SCL Electrical Vault Base
013094	<b>cover</b> , 4-foot by 4-foot with one 3- by 3-foot, non-slip solid hatch	44-33F Cover w/ I.D. Marker-3150065	440-13 SCL SlipNot Vault Lid
013095	<b>cover</b> , 4- by 4-foot with one 42-inch round, solid cover and frame, H-20	44-38C Cover w/ I.D. Marker with 42" Cover and Frame	440-02 SCL Lid w/42" MH R&C
013157	<b>cover</b> , 4-foot, 4-inch by 4-foot, 7-inch with one 36-inch by 36-inch, non-slip, solid hatch, H-30	Oversized Special 44 Top w/3636 LW Hatch	—
013120	<b>assembled enclosure</b> with 4-foot by 4-foot cover with one 3-foot by 3-foot, non-slip, H-20, solid hatch	444-LA Base w/ Iron and GRD In and Out w/332P Non-Slip-SCL-3150065	444 SCL Base and Lid with 13 SlipNot Hatch
013121	<b>assembled enclosure</b> with 4-foot by 4-foot cover with one 42-inch round, solid cover and frame, H-20	444-LA Base w/ Iron and GRD In & Out w/42" Cover and Frame-SCL	444 SCL Base and Lid with 42" Ring and Cover
013158	<b>assembled enclosure</b> with 4-foot, 4-inch by 4-foot, 7-inch cover with one 36-inch by 36-inch, non-slip, solid hatch, H-30	444-LA Base w/ Iron and GRD In & Out w/ Oversized Special 44 Top w/3636 LW Hatch	—

**9. References**

**Detter, Chris**; SCL Distribution Engineer, subject matter expert for 7203.26

**Ng, Sharon**; SCL Civil Engineer, subject matter expert for 7203.26

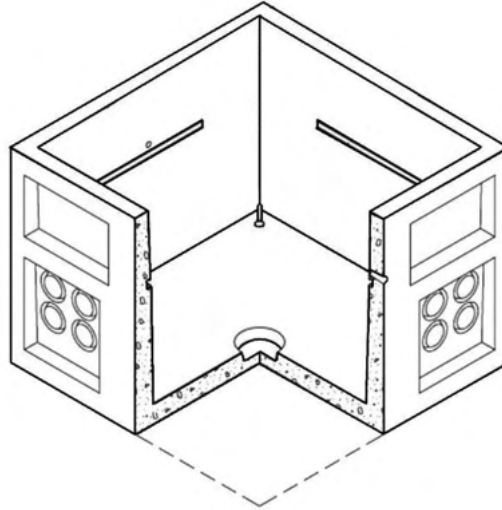
**SCL 7203.21**; "Precast Reinforced Concrete Structure, General"; Material Standard

**SCL 7204.70**; "Frames and Covers, 42-Inch Round, Iron"; Material Standard

**SCL 9246.10**; "Pulling Irons - Fundamentals and Detailed Requirements, Looped Radial and Network Systems"; Design Standard

**Wang, Quan**; SCL Standards Engineer, originator and subject matter expert for 7203.26

**504 Electric Vault, Primary Service**



**1. Table of Contents**

2. Scope .....	1
3. Application .....	2
4. General Requirements .....	2
5. Component Requirements .....	2
5.1 Grounding and Bonding .....	2
5.2 Base .....	2
5.3 Cover .....	3
6. Issuance .....	5
7. Approved Manufacturer .....	5
8. References .....	5
9. Sources .....	5

**2. Scope**

This standard covers the detailed requirements for 504 electrical vault components (base and cover with hatch) and assembled 504 electric vaults. Components can be ordered separately or as complete assemblies, which include covers.

Standards Coordinator  
 Quan Wang

Standards Supervisor  
 John Shipek

Unit Director  
 Darnell Cola

This standard applies to the following Seattle City Light (SCL) stock numbers:

Stock No.	Description
013096	<b>Base</b> , standard 507
013097	<b>Cover</b> with hatch, H-20
013098	<b>Cover</b> with 42-in round solid hatch and frame, H-20
013159	<b>Cover</b> with solid hatch, H-30
013122	<b>Assembly</b> , base and cover with solid hatch, H-20
013123	<b>Assembly</b> , base and cover with 42-in round solid hatch and frame, H-20
013160	<b>Assembly</b> , base and cover with solid hatch, H-30

### 3. Application

504 vaults are used to construct underground electric systems. The precast concrete structure may be used to house load break junction boxes, and in making service connections and splices for the distribution system.

H20-rated 504 vault assemblies are not to be used in high density locations.

Depending on the selected application, a 504 vault can be defined as a handhole or a vault. When SCL uses a 504 for primary service, it is designated a vault. For non-primary service it is typically designated a handhole (not covered in this standard).

Also depending on the application selected, the vault may need to be customized with a different entry opening.

### 4. General Requirements

This detailed standard is to be used in conjunction with the latest revisions of:

**SCL 7203.21**; "Precast Reinforced Concrete Structures – General"

**SCL 7204.70**; "Frames and Covers, 42-Inch Round, Iron"

### 5. Component Requirements

#### 5.1 Grounding and Bonding

Vault grounding shall comply with SCL 7203.21, Section 9, Grounding.

#### 5.2 Base

**Table 5.2a. Base Components**

	Size, Nominal (in)	Location	Per Location	Total Number
<b>Knockouts</b>				
Round	4-3/4 dia	All 4 walls, on bottom	8 ea side	32
Ground rod	2 dia	2 corners of floor	1 ea	02
<b>Channels</b>				
Galvanized "C" channel, horizontal, embedded in walls	36 length	All walls, above all knockouts	1 ea side	04
<b>Sump</b>	12 dia	Floor, center	1, to one side	01
<b>Pulling Irons</b>	1/2 dia	1 ea corner of floor (typical)	1 ea corner	04
<b>Lift Holes</b>	1-1/2 dia	2 walls, center of wall, above channel, opposite	1 ea side	02
<b>Ground Inserts</b> , bronze	1/2 dia	2 walls, opposite, internal and external	2 ea side	04
<b>Ladder</b>	—	Not required	—	—

Base shall have dimensions as shown in Tables 5.2b and 5.2c, and Figure 5.2.

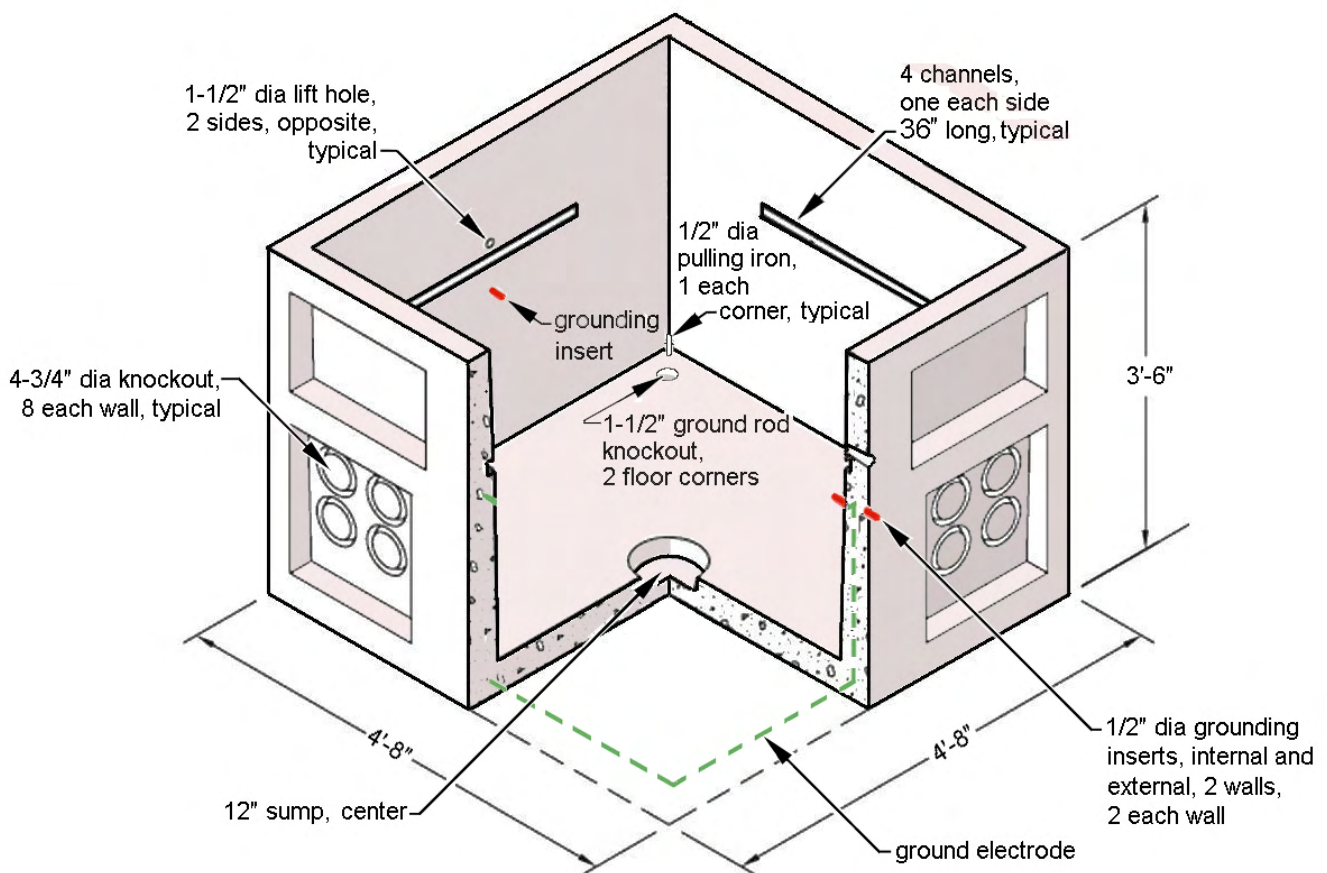
**Table 5.2b. Base Dimensions, Inside, Nominal (ft-in)**

Length	Width	Height
4-2	4-2	3-2

**Table 5.2c. Base Dimensions, Outside, Nominal (ft-in)**

Length	Width	Height
4-8	4-8	3-6

**Figure 5.2. Base**



**5.3 Covers**

Covers shall consist of a concrete collar with a slip-resistant hatch.

Covers shall have dimensions as shown in Table 5.3. Note: cover for square opening is tapered from top to bottom and is notched on the bottom to fit inside the sides of the vault.

Covers shall have 3/4-inch diameter (nominal) lift insert at each corner on the top, as shown in Figure 5.3a.

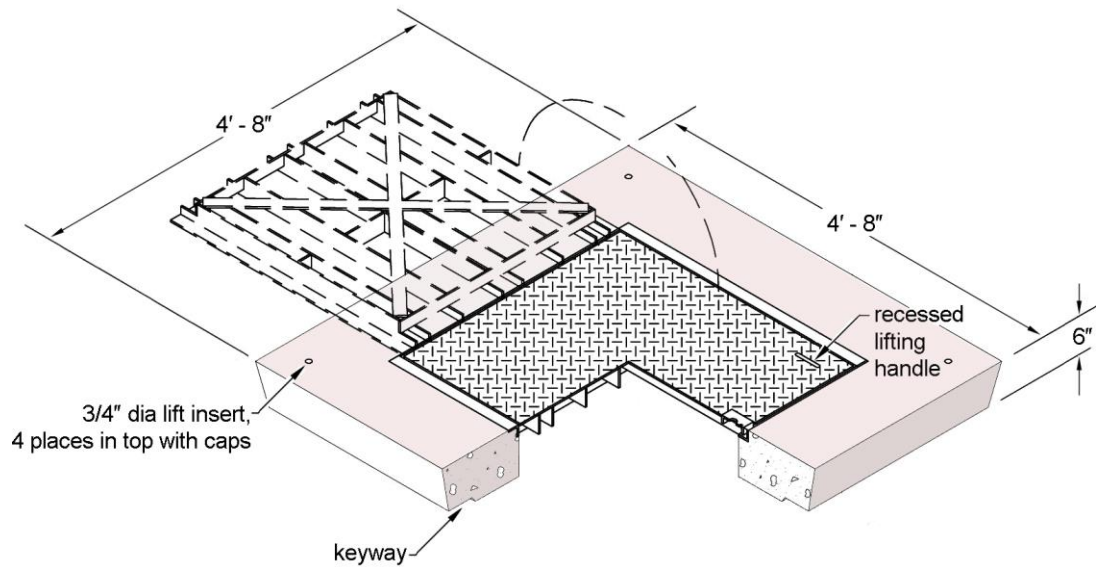
Caps shall be provided to cover the lift inserts.

The 42-inch round cover shall include a 4-in deep, round frame, as shown in Figure 5.3b.

Equipment hatches shall have:

- 3 ft x 3 ft dimension
- H20 rating
- Recessed lift handles
- Non-slip surfaces
- One handle located on each of the short ends of the hatch
- 5/8-in bonding point hole on support bar for grounding hatch
- Hatch-locking mechanism with Penta head bolt

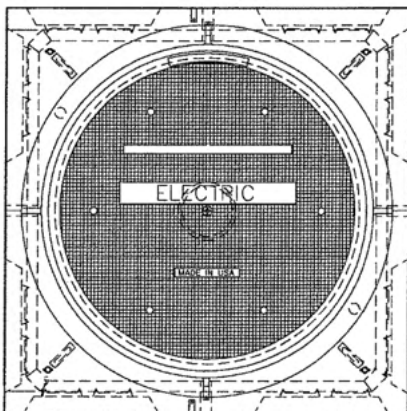
**Figure 5.3a. Cover with Hatch**



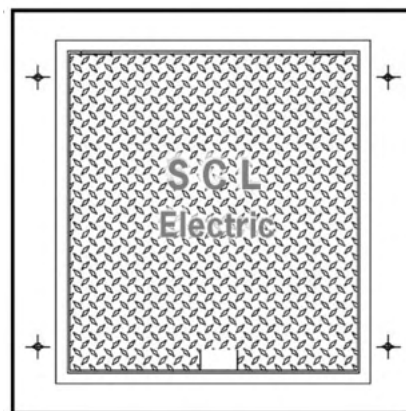
**Table 5.3. Cover Dimensions, Nominal**

Stock No.	Concrete Collar (ft-in)			Opening (in)	Hatch
	Length	Width	Thickness		
013094	4-8	4-8	0-6	36 x 36	Solid, H-20
013095	4-8	4-8	0-6	42 dia, round	42-in round, solid, H-20
013159	4-8	4-8	0-6	36 x 36	Solid, H-30

**Figure 5.3b. Cover with 42-Inch Round Hatch**



**Figure 5.3c. Cover with H30 Hatch**



## 6. Issuance

Unit: EA

---

## 7. Approved Manufacturers

Stock No.	Description	Oldcastle/Utility Vault Catalog No.
013096	<b>Base</b> , standard 504	504-LA Base w/ Iron and GRD In & Out
013097	<b>Cover</b> with hatch, H20	55-332p Cover w/ I.D. Marker
013098	<b>Cover</b> with 42-in round solid hatch and frame, H-20	55-42C Cover w/ I.D. Marker and 42" Cover & Frame
013159	<b>Cover</b> with solid hatch, H-30	55-w/3437 LW Hatch Cover w/ I.D. Marker
013122	<b>Assembly</b> , base and cover with solid hatch, H-20	504-LA Base w/ Iron and GRD In & Out w/332P Non-Slip-SCL
013123	<b>Assembly</b> , base and cover with 42-in round solid hatch and frame, H-20	504-LA Base w/ Iron and GRD In & Out w/42" Cover & Frame-SCL
013160	<b>Assembly</b> , base and cover with solid hatch, H-30	504-LA Base w/ Iron and GRD In & Out w/3437 LW Non-Slip-SCL

---

## 8. References

**SCL Material Standard 7203.21**; "Precast Reinforced Concrete Structure, General"

**SCL Material Standard 7204.70**; "Frames and Covers, 42-Inch Round, Iron"

---

## 9. Sources

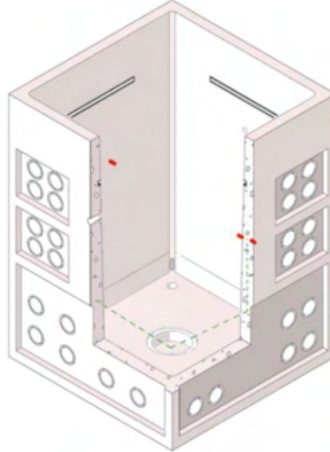
**Detter, Chris**; SCL Distribution Engineer and subject matter expert for 7203.31  
(chris.detter@seattle.gov)

**Ng, Sharon**; SCL Civil Engineer and subject matter expert for 7203.31  
(sharon.ng@seattle.gov)

**SCL Design Standard 9246.10**; "Pulling Irons - Fundamentals and Detailed Requirements, Looped Radial and Network Systems"

**Wang, Quan**; SCL Standards Engineer, originator, and subject matter expert for 7203.31  
(quan.wang@seattle.gov)

## 507 Electric Vault, Primary Service



### 1. Scope

This standard covers the requirements for 507 (also known as 557) electrical vault components (vault base and cover with hatch) and assembled 507 units.

Components can be ordered separately or ordered as an assembly.

This standard applies to the following Seattle City Light (SCL) stock numbers:

Stock No.	Description
013101	<b>Base</b> , standard 507
013102	<b>Cover</b> with hatch
013124	<b>Assembly</b> (base and cover with hatch)
013688	<b>Cover</b> with 42-in blackout
013169	<b>Assembly</b> (base and cover with 42-in blackout)

### 2. Application

507 vaults are used to construct the underground electric system. This precast concrete vault may be used to house medium-size transformers, loadbreak junction boxes, and service connections and splices for the distribution system.

H20-rated 507 vault assemblies should not be used in high-density locations.

Depending on the selected application, the 507 vault can be defined as a handhole or a vault. When SCL uses the 507 vault for primary service, it is designated a vault. For non-primary service, it is typically designated a handhole (not covered in this standard).

A 42-in round iron frame and cover must be ordered separately. For detailed material specifications for the iron frame and cover, see SCL 7204.70, "Frame and Covers, 42-Inch Round, Iron."



### 3. General Requirements

This standard is to be used in conjunction with the latest revision of SCL 7203.21, "Precast Reinforced Concrete Structures, General."

### 4. Component Requirements

#### 4.1 Grounding and Bonding

Vault grounding shall conform to SCL 7203.21.

#### 4.2 Base

**Table 4.2a. Vault Base Components**

	Size, Nominal (in)	Location	Per Location	Total Number
<b>Knockouts</b>				
Round	4-3/4 dia	All 4 walls, on bottom	8 ea side	32
Round	4-3/4 dia	4 panels of 4 on middle of all walls	16 ea side	64
Ground rod	2 dia	2 corners of floor	1 ea	2
<b>Channels</b>				
Galvanized "C" channel, horizontal, embedded in walls	36 long	All walls, above all knockouts	1 ea side	4
<b>Sump</b>	12 dia	Floor, center	1, to one side	1
<b>Pulling irons</b>	1/2 dia	1 ea corner of floor (typical)	1 ea corner	4
<b>Lift holes</b>	1-1/2 dia	2 opposite walls, center wall horizontally	1 ea side	2
<b>Ground Inserts, bronze</b>	1/2 dia	2 walls, opposite, internal and external	2 ea side	4
<b>Ladder</b>	–	Not required	–	–

The base shall have dimensions as shown in Tables 4.2b and 4.2c, and Figure 4.2.

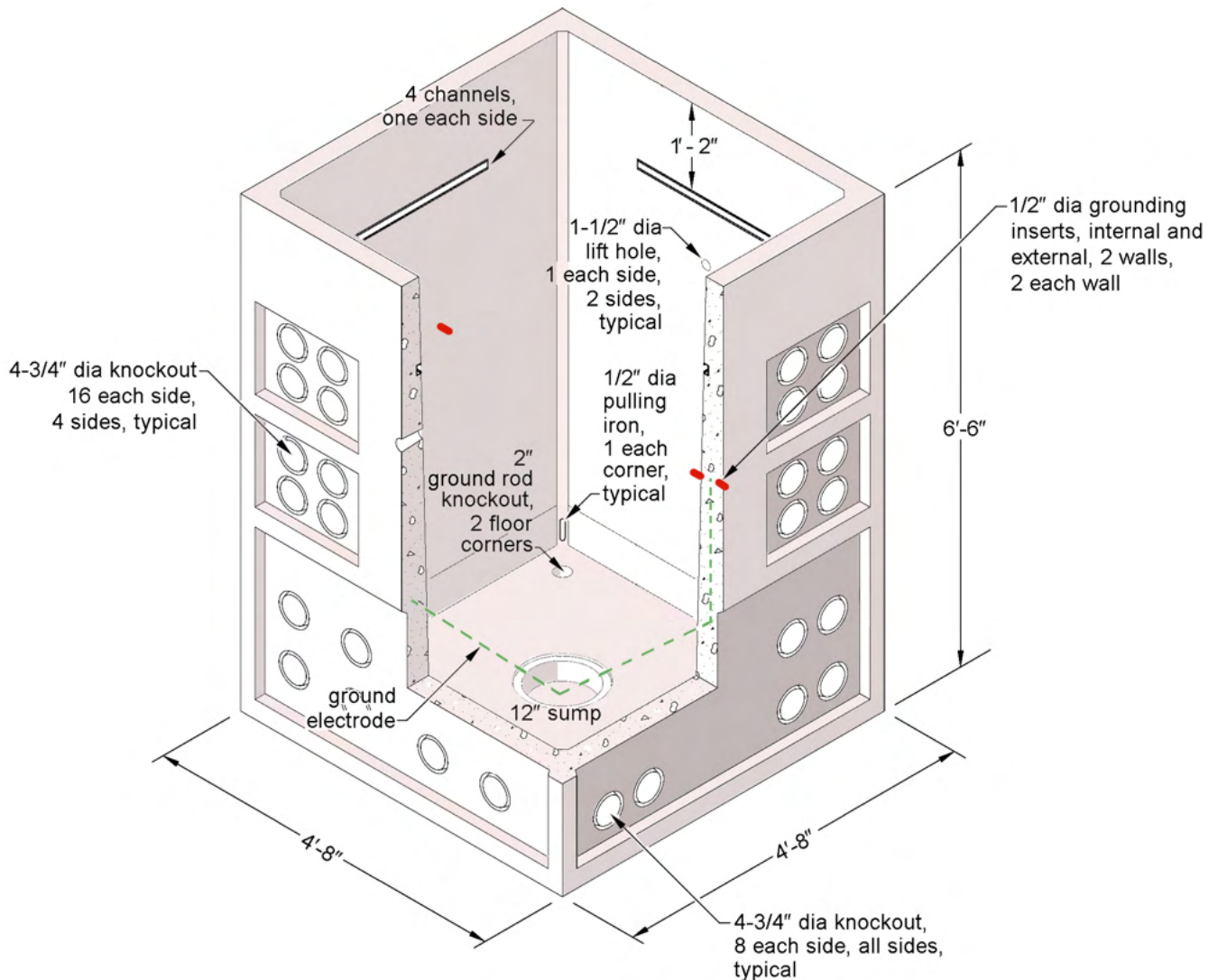
**Table 4.2b. Base Dimensions, Inside, Nominal (ft-in)**

Length	Width	Height
4-2	4-2	6-0

**Table 4.2c. Base Dimensions, Outside, Nominal (ft-in)**

Length	Width	Height
4-8	4-8	6-6

**Figure 4.2. Base**



**4.3 Cover**

Covers shall consist of a concrete collar with a slip-resistant steel-grated vent hatch or a concrete collar with a 42-in round blockout.

Covers shall have dimensions as shown in Table 4.3. Note: The cover for a square opening is tapered from top to bottom and is notched on the bottom to fit inside the sides of the vault.

Covers shall have a 3/4-in diameter (nominal) lift insert at each corner on the top as shown in Figure 4.3a.

Caps shall be provided to cover the lift inserts.

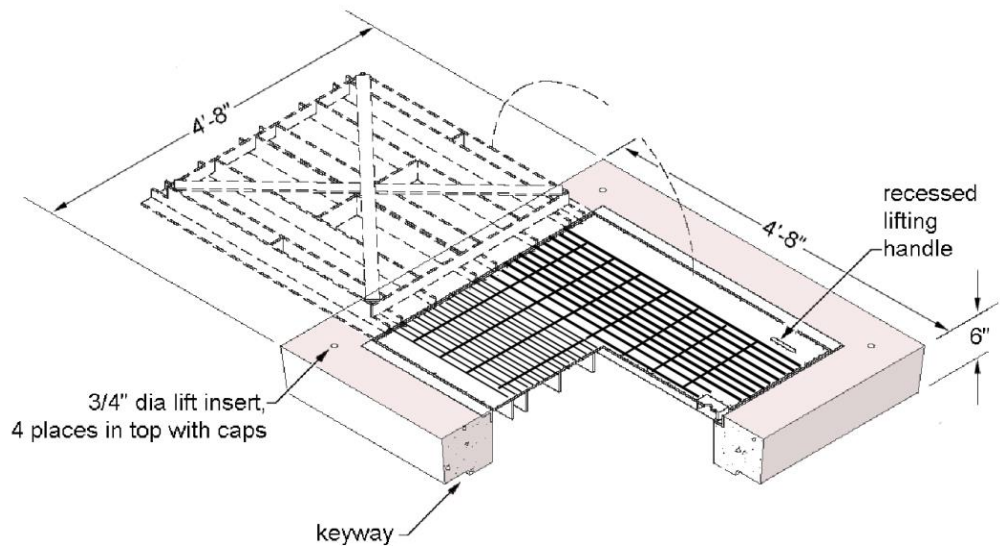
Covers shall have a keyway to ensure a tight fit.

Covers with a 42-in round blockout are used in conjunction with a 42-in round hatch and frame as shown in Figure 4.3b.

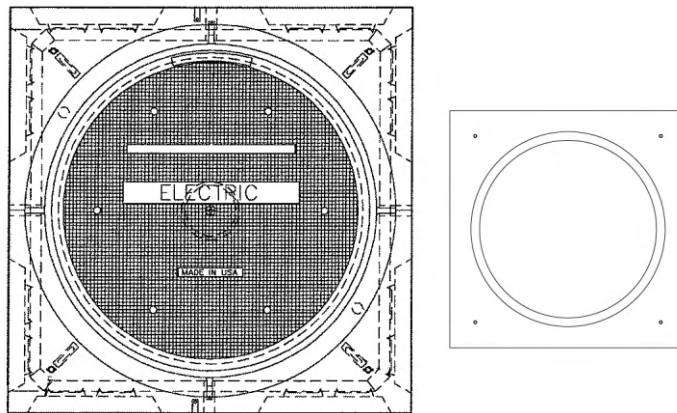
The steel-grated vent hatch shall have:

- 3 ft x 3 ft dimension
- H20 rating
- Recessed lift handles
- Non-slip surfaces
- One handle located on each of the short ends of the hatch
- 5/8-in bonding point hole on support bar for grounding hatch
- Hatch-locking mechanism with Penta head bolt

**Figure 4.3a. Cover with Hatch**



**Figure 4.3b. Cover with 42-in Round Blockout**



**Table 4.3. Cover Dimensions, Nominal**

Stock No.	Concrete Collar			Opening (in)
	Length (ft-in)	Width (ft-in)	Thickness (in)	
013102	4-8	4-8	6	36 x 36
013688	4-8	4-8	6	42 dia, round

## 5. Issuance

Unit: EA

---

## 6. Approved Manufacturer

<b>Stock No.</b>	<b>Description</b>	<b>Catalog Number</b>
		<b>Oldcastle/Utility Vault</b>
130101	<b>Base</b> , standard 507	507-LA Base w/ Irons and GRD In & Out
130102	<b>Cover</b> , with hatch	55-332 GV
013124	<b>Assembly</b> ; base and cover with hatch	507-LA Base w/ Iron and GRD In & Out w/Grate Vent, SCL
013688	<b>Cover</b> , with 42-in blackout	55-42C
013169	<b>Assembly</b> ; base and cover with 42-in blackout	507-LA with 55-42C

---

## 7. References

**SCL Material Standard 7203.21**; "Precast Reinforced Concrete Structure, General"

**SCL Material Standard 7204.70**; "Frames and Covers, 42-Inch Round, Iron"

---

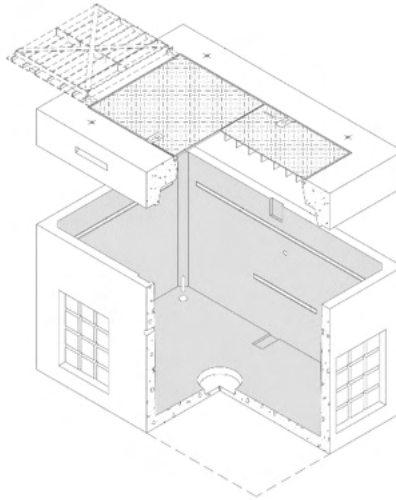
## 8. Sources

**Detter, Chris**; SCL Distribution Engineer and subject matter expert for 7203.36  
(chris.detter@seattle.gov)

**Ng, Sharon**; SCL Civil Engineer and subject matter expert for 7203.36  
(sharon.ng@seattle.gov)

**Wang, Quan**; SCL Standards Engineer, originator, and subject matter expert for 7203.36  
(quan.wang@seattle.gov)

## 575 Electric Vault, Primary Service



### 1. Scope

This standard covers the detailed requirements for 575 electrical vault components (vault base and cover with hatches) and 575 vault assemblies. Components may be ordered separately or ordered as an assembly.

This standard applies to the following Seattle City Light (SCL) stock numbers:

Stock No.	Description
014370	Base, standard 575
014371	Cover with two hatches
014372	Assembly (base and cover with hatches)

### 2. Application

575 vaults are used in the construction of underground electric systems. Precast concrete structures are used to house loadbreak junction boxes, act as a pulling vault, or be used to make service connections and splices for the SCL system.

575 vault assemblies are not to be used in high traffic locations.

Standards Coordinator  
Quan Wang

Standards Supervisor  
John Shipek

Unit Director  
Andrew Strong

### 3. Requirements

#### 3.1 General

This standard is to be used in conjunction with the latest revision of SCL 7203.21, "Precast Reinforced Concrete Structures, General."

#### 3.2 Grounding and Bonding

Vault grounding shall conform to SCL 7203.21.

#### 3.3 Base

**Table 3.3a. Vault Base Components**

	Size, Nominal (in)	Location	Per Location	Total Number
<b>Knockouts</b>				
Waffle (12 6-in squares)	18 x 24	All 4 walls, 18 in below the top of wall toward the wall corner	2 ea side	8
Ground rod	2-1/2 dia	2 corners of floor	1 ea	2
<b>Channels</b>				
Galvanized "C" channel, horizontal, embedded in walls				
	36 long	End walls, above waffle, 9 in from top of wall	1 ea side	2
	72 long	Side walls, above waffle, 9 in from top of wall	1 ea side	2
	24 long	Between waffle knockouts, 19.5 inches from channel above	1 ea side	2
<b>Sump, round</b>	12 dia	Floor, off-center (long axis)	1, to one side	1
<b>Pulling irons</b>	1/2 dia	As requested per project; 1 ea corner of floor (typical)	1 ea corner	4
<b>Lift holes</b>	1-1/2 dia	2 opposite walls, centered on side wall	1 ea side	2
<b>Ground Inserts, bronze</b>	1/2 dia	2 walls, opposite, internal and external	2 ea side	4
<b>Ladder</b>	–	Not required	–	

The base shall have dimensions as shown in Tables 3.3b and 3.3c, and Figure 3.3.

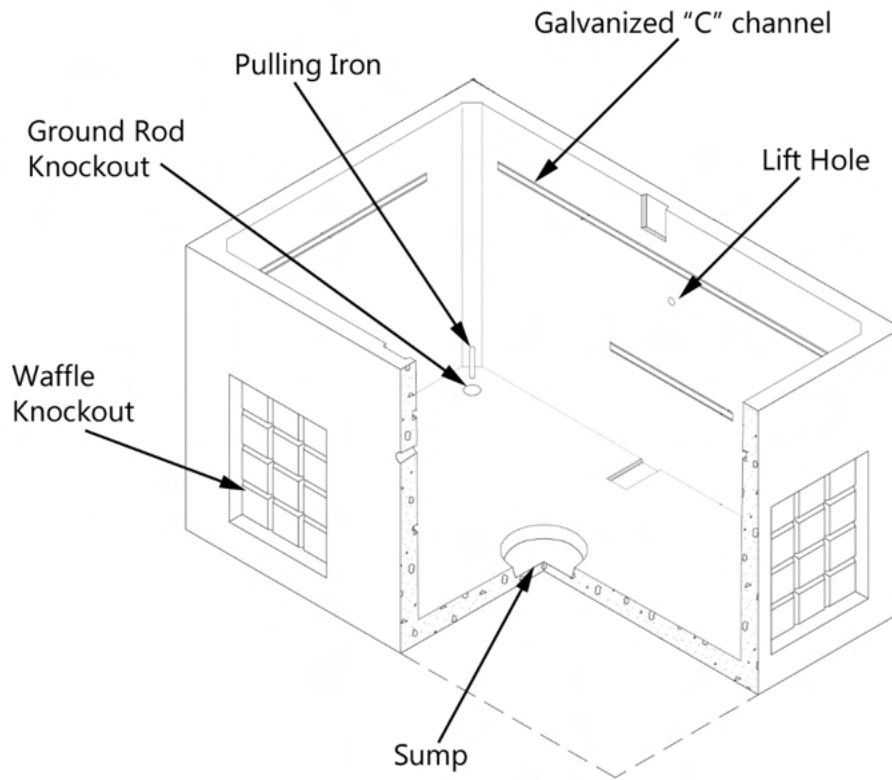
**Table 3.3b. Base Dimensions, Inside, Nominal (ft-in)**

Length	Width	Height
6-6	4-2	3-8

**Table 3.3c. Base Dimensions, Outside, Nominal (ft-in)**

Length	Width	Height
7-0	4-8	4-0

**Figure 3.3. Base**



### 3.4 Cover

Vault cover shall consist of a concrete collar with two 3 ft x 3 ft non-slip, spring-assisted, solid hatches.

Cover shall have overall dimensions as shown in Table 3.4.

Cover shall have a 3/4-in diameter (nominal) lift insert at each corner on the top, as shown in Figure 3.4.

UV-resistant caps shall be provided to cover the lift inserts.

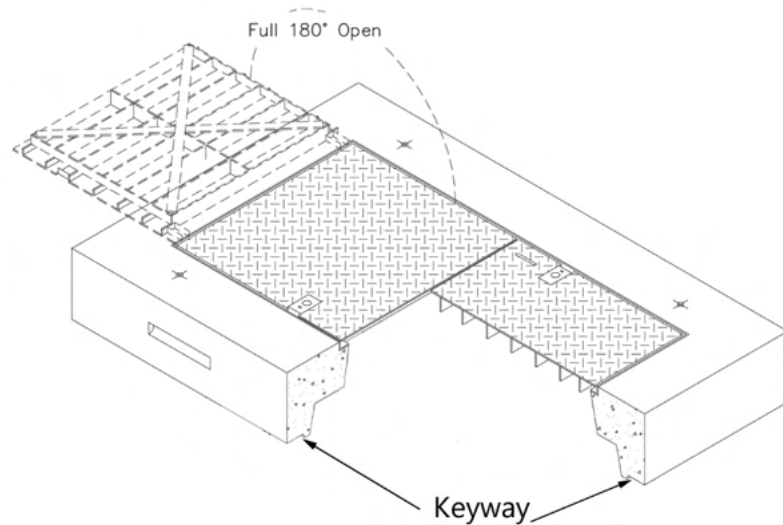
Cover shall have a keyway to ensure a tight fit.

Hinges for the hatch shall be along the short end of the cover slab.

The solid hatch shall have the following attributes:

- 3 ft x 3 ft dimension
- H20 rating
- Two recessed lift handles
- Non-slip surfaces
- 5/8-in bonding point hole on support bar for grounding hatch
- Hatch-locking mechanism with Penta head bolt
- "Electric" labeled on top of the hatch.

**Figure 3.4. Cover With Two Hatches**



**Table 3.4. Cover Dimensions, Nominal**

Concrete Collar			
Length (ft-in)	Width (ft-in)	Thickness (in)	Opening (in)
7-0	4-8	12	6 x 3

**4. Issuance**

Unit: EA

**5. Approved Manufacturer**

Stock No.	Description	Oldcastle/Utility Vault Catalog No.
014370	<b>Base</b> , standard 575	575-BL
014371	<b>Cover</b> , with two hatches	57-2-33F
014372	<b>Assembly</b> ; base and cover with hatches	575-LA

**6. References**

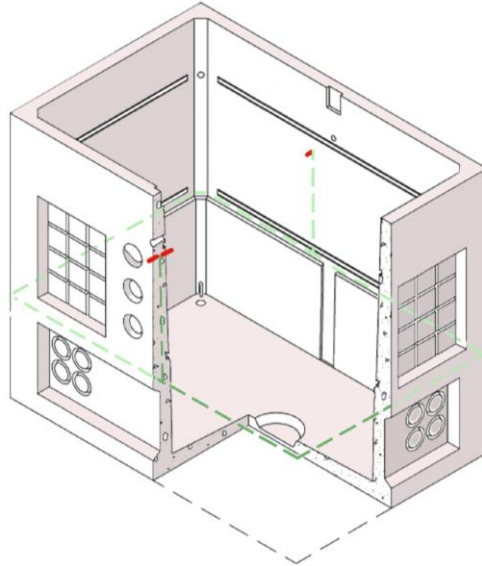
**SCL Material Standard 7203.21**; "Precast Reinforced Concrete Structure, General"

**7. Sources**

**Wang, Quan**; SCL Standards Engineer, originator, and subject matter expert for 7203.38 (quan.wang@seattle.gov)



**577 Electric Vault, Primary Service**



**1. Table of Contents**

1. Table of Contents .....	1
2. Scope .....	1
3. Application .....	2
4. General Requirements .....	2
5. Component Requirements .....	2
5.1. Grounding and Bonding .....	2
5.2. Vault Base .....	2
5.3. Divider Wall .....	3
5.4. Vault Cover .....	4
6. Vault Assemblies .....	5
7. Issuance .....	5
8. Approved Manufacturer .....	5
9. References .....	6

**2. Scope**

This standard covers the detailed requirements for 577 electrical vault components (vault base, cover with hatches, and divider walls) and 577 electric vaults assembled from those components. The basic components can be ordered separately, or they can be ordered as assembled vaults with covers.

This standard applies to the following Seattle City Light Stock Numbers:

**Stock**

**Number 577 Vault Components**

013089	<b>vault base</b> , standard 577
013090	<b>removable divider wall</b> , standard 577
013091	<b>cover</b> , 7-foot by 4-foot-8-inch by 12-inch with two 3- by 3-foot, non-slip, solid hatches, H-20
013092	<b>cover</b> , 7-foot by 4-foot-8-inch by 12-inch with two 3- by 3-foot, H-20 hatches (one non-slip, solid hatch and one grated vent hatch)
013151	<b>cover</b> , 7-foot-6-inch by 5-foot-2-inch with two non-slip, H-30 hatches

**Stock**

**Number Assembled 577 Vaults with Cover**

013125	<b>assembled 577 vault</b> with two 3- by 3-foot, non-slip, H-20 solid hatches
013126	<b>assembled 577 vault</b> with divider wall and with two 3- by 3-foot, H-20 hatches (one non-slip, solid hatch and one grated vent hatch)
013127	<b>assembled 577 vault</b> with divider wall and with two 3- by 3-foot, non-slip, H-20 solid hatches
013152	<b>assembled 577 vault</b> with two non-slip, H-30 hatches

standards coordinator	standards supervisor	unit director
 Quan Wang	 John Shipek	 Andrew Strong

**3. Application**

577 vaults are intended for use in the construction of underground electric systems. This precast concrete structure may be used to house medium-size transformers, loadbreak junction boxes, and in making service connections and splices for the distribution system.

The H20-rated 577 vault assemblies are not intended to be used in high density locations.

The standard 577 vault assembly typically consists of the 577 base (Stock Number 013089) and the 7-foot by 4-foot-8-inch cover with two 3- by 3-foot non-slip, H-20 solid hatches (Stock Number 013091).

Due to different applications, the vault may need to be customized with a divider wall and/or different entry openings and hatches.

Depending on the application for the enclosure selected, it can be defined as a handhole or a vault. When Seattle City Light uses the 577 enclosure for primary service, the 577 enclosure will be designated as a vault. For non-primary service the 577 enclosure can typically be referred to as a handhole (not covered in this Standard).

Steps for selecting the proper vault assembly for your application:

1. Select vault base
2. Determine if divider wall is needed
3. Select removable divider wall (optional)
4. Select cover with hatches

**4. General Requirements**

This detailed standard is to be used in conjunction with the latest revision of Seattle City Light Material Standard 7203.21, "Precast Reinforced Concrete Structures – General."

**5. Component Requirements****5.1 Grounding Requirements**

Vault grounding shall comply with Material Standard 7203.21, Section 9, Grounding.

**5.2 Vault Base**

The SCL 577 vault base (Stock No. 013089) shall have overall nominal dimensions of 7 feet by 4 feet 8 inches by 6 feet high as shown in Figure 6.2.

Approximate weight is 6,000 pounds.

**Table 5.2, Vault Base Attributes**

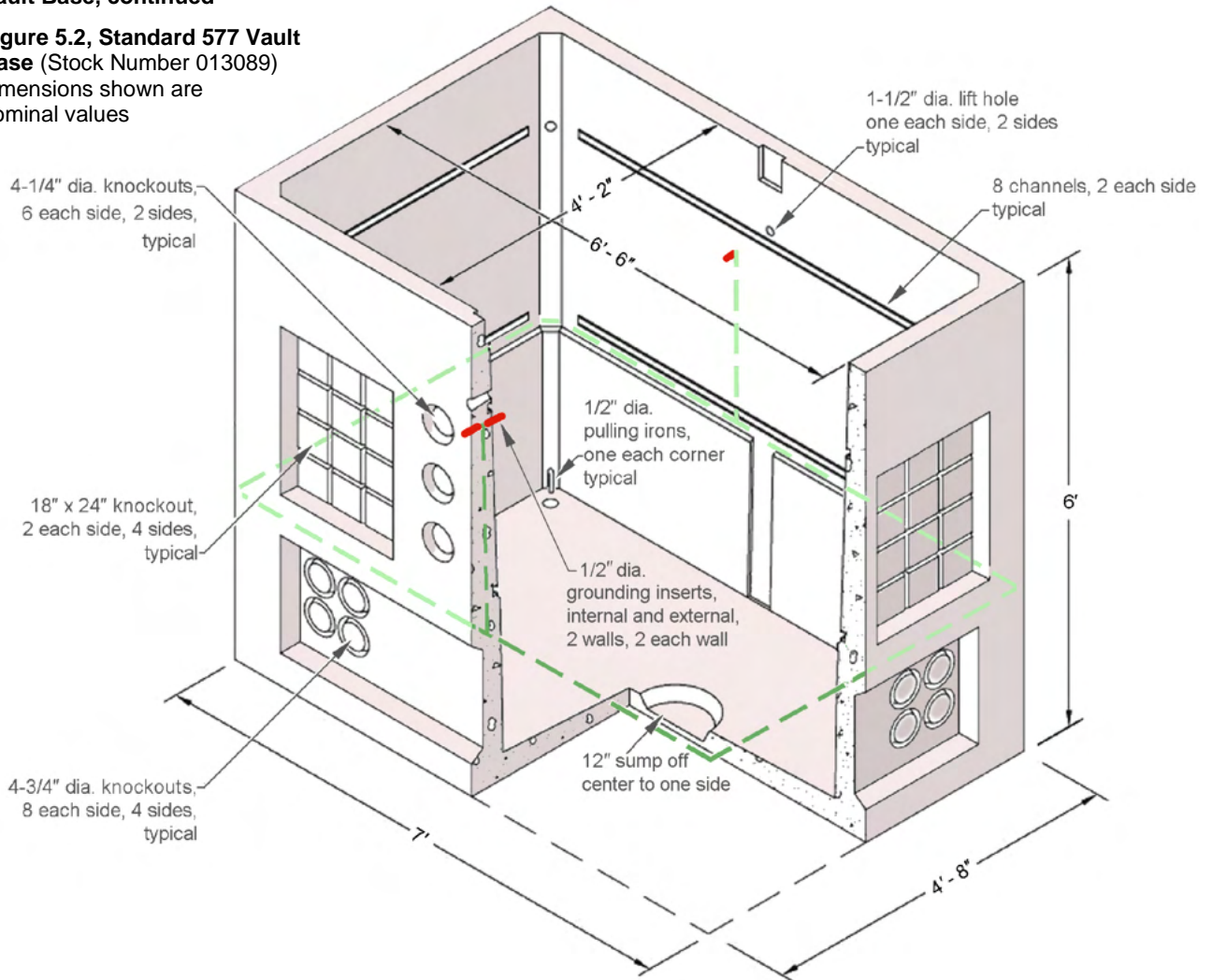
All standard 577 vault bases shall have the following features:

	Size, Nominal, in	Location	Per Location	Total Number
<b>Knockouts</b>				
round	4-3/4 dia	all 4 walls, on bottom	8 ea side	32
round	4-3/4 dia	3 rows of 2 in center of 2 long walls	6 ea side	12
waffle (12 - 6" squares)	18 x 24	all 4 walls	2 ea side	8 waffles
ground rod	2 dia	2 corners of floor	1 ea	2
<b>Channels</b>				
galvanized "C" channel, horizontal, embedded in walls	42 long	short walls, above waffle	1 ea side	2
	42 long	short walls, below waffle	1 ea side	2
	72 long	long walls, above waffle	1 ea side	2
	72 long	long walls, below waffle	1 ea side	2
<b>Sump, round</b>	12 dia	floor, off center (long axis)	1, to one side	1
<b>Pulling Irons</b>	1/2 dia	1 ea corner of floor (typical)	1 ea corner	4
<b>Lift Holes</b>	1-1/2 dia	2 center of wall, just below channel, long walls, opposite	1 ea side	2
<b>Ground Inserts, bronze</b>	1/2 dia	on opposite long walls, on the internal and external side of walls	2 ea side	4
<b>Ladder</b>		not required		

**5. Component Requirements, continued**

**5.2 Vault Base, continued**

**Figure 5.2, Standard 577 Vault Base** (Stock Number 013089)  
dimensions shown are nominal values



**5.3 Removable 577 Divider Wall** (Stock Number 013090)

Divider wall shall be reinforced with #4 rebar. Divider wall shall be 3 inches thick (nominal). Approximate weight is 1,000 pounds.

The removable 577-divider wall shall include:

1/2-inch diameter lift ring, placed in the top edge

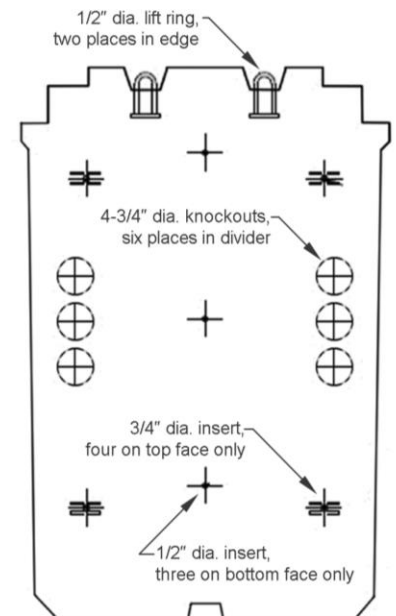
4-3/4-inch diameter knockouts, 6 locations in divider, 3 to a side laterally

1/2-inch diameter inserts, 3 on bottom face of wall only

3/4-inch diameter inserts, 4 on the top face of wall only

See Figure 5.3.

**Figure 5.3, Removable Divider Wall**



**MATERIAL STANDARD**

**5. Component Requirements, continued**

**5.4 Vault Cover**

Covers shall have a nominal overall dimension of 7 feet by 4 feet 8 inches. Thickness shall be 12 inches. Approximate weight is 2,200 pounds.

All covers shall have 3/4-inch lift insert at each corner on the top, as shown in Figure 5.4.

Caps shall be provided to cover the lift inserts.

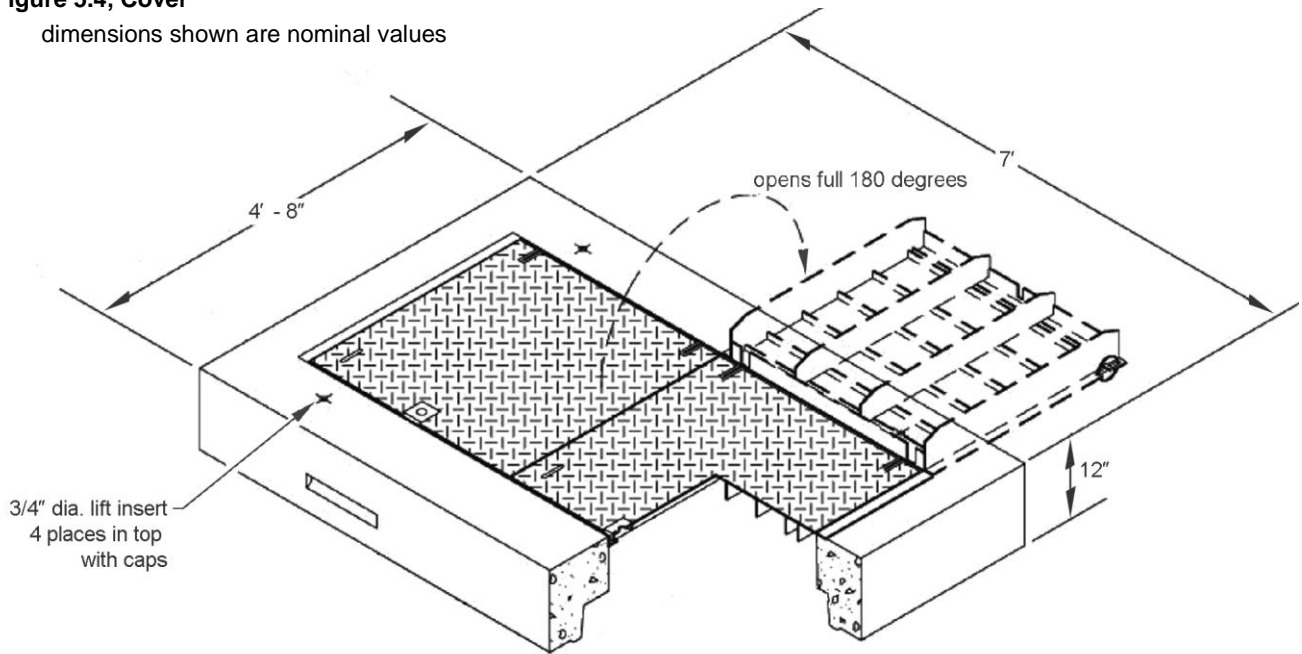
Hinges for the lids shall be along the length of the cover.

All hinged hatches shall open 180 degrees, or flat.

Covers shall have a keyway to match the base for proper assembly.

**Figure 5.4, Cover**

dimensions shown are nominal values



**Table 5.4, 577 Vault Cover Options**

Stock Number	Inside Dimensions, Nominal, ft-in		Outside Dimensions, Nominal, ft-in		Hatch Options
	Length	Width	Length	Width	
013091	6-6	4-2	7-0	4-8	with two 3- by 3-foot, non-slip, H-20 solid hatches
013092	6-6	4-2	7-0	4-8	with two 3- by 3-foot, H-20 hatches: one non-slip, solid hatch and one grated vent hatch
013151	6-6	4-2	7-6	5-2	with two non-slip, H-30 LW hatches

**MATERIAL STANDARD**

577 Electric Vault, Primary Service

standard number: **7203.41**

superseding: August 27, 2018 1

effective date: October 18, 2019

page: 5 of 6

**6. 577 Vault Assemblies****Table 6, Assembled 577 Vault Components**

Assembled Vault Stock Number	Vault Base Stock Number	Divider Wall Stock Number	Cover Number	Hatches	
				1	2
013125	013089	none	013091	H-20 solid	H-20 solid
013126	013089	013090	013192	H-20 solid	H-20 grate
013127	013089	013090	013191	H-20 solid	H-20 solid
013152	013089	none	013151	H-30 solid	H-30 solid

Refer to Table 6 for the various components included in each vault assembly.

**6.1 Assembly Options**

All vault assemblies use the same vault base. The assemblies differ on whether they are provided with a divided wall or not and on the type of hatch. Depending on the type of cover hatches desired, the vault base may be paired with a different cover size with appropriate hatches, as shown in Table 6.

**6.2 Assembly Requirements**

All solid hatches are and have non-slip surfaces.

Each section of the vault components shall have keyways for proper assembly.

**7. Issuance**

Unit: EA

**8. Approved Manufacturer**

Stock Number	Description	Catalog Number
		Oldcastle/Utility Vault
013089	<b>vault base</b> , standard 577	577-LA w/ GRD In & Out
013090	<b>removable divider wall</b> , standard 577	577-Divider Wall
013091	<b>vault cover</b> , 7-foot by 4-foot-8-inch with two 3- by 3-foot, non-slip, H-20, solid hatches	57-2-332-NS-SA-80
013092	<b>vault cover</b> , 7-foot by 4-foot-8-inch with two 3- by 3-foot, H-20 cover hatches (one non-slip, solid hatch and one grated vent hatch)	57-2-332-NS-GV-SA-80
013151	<b>vault cover</b> , 7-foot-6-inch by 5-foot-2-inch with two non-slip, H-30 hatches	57 Top w/ LW Hatch 34" x 74"
013125	<b>assembled 577 vault</b> with two 3- by 3-foot, non-slip, H-20 solid hatches	577-LA w/ GRD In & Out w/ 2-33 cover - SCL
013126	<b>assembled 577 vault</b> with <b>divider wall</b> and with two 3- by 3-foot, H-20 hatches (one non-slip, solid hatch and one grated vent hatch)	577-LA w/ Iron, GRD In & Out w/ grate and 33 cover - SCL
013127	<b>assembled 577 vault</b> with <b>divider wall</b> and with two 3- by 3-foot, non-slip, H-20 solid hatches	577-LA w/ Iron, GRD In & Out w/ 2-33 cover - SCL
013152	<b>assembled 577 vault</b> with two non-slip, H-30 hatches	577-LA w/ Iron, GRD In & Out w/ LW Hatches

**9. References**

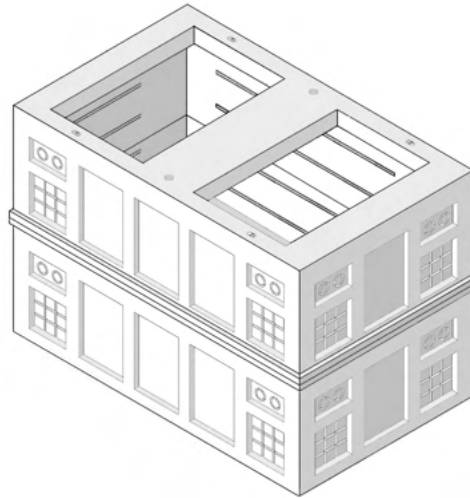
**Detter, Chris**; SCL Distribution Engineer, subject matter expert for 7203.41

**Ng, Sharon**; SCL Civil Engineer, subject matter expert for 7203.41 (sharon.ng@seattle.gov)

**SCL 7203.21**; "Precast Reinforced Concrete Structure, General"; Material Standard

**Wang, Quan**; SCL Standards Engineer, originator and subject matter expert for 7203.41 (quan.wang@seattle.gov)

## 712 Electric Vault, Primary Service



### 1. Table of Contents

2. Scope .....	1
3. Application .....	2
4. General Requirements .....	4
5. Vault Base Requirements .....	4
6. Top Section Requirements .....	5
7. Covers, Risers and Hatches .....	7
8. Vault Assembly and Packaging .....	8
9. Issuance .....	13
10. Approved Manufacturers .....	13
11. References .....	13

### 2. Scope

This standard covers the requirements for the 712 electrical vault components (vault base and top sections) and the assembled 712 electric vaults.

The 712 vault is considered a ring vault by Seattle City Light (SCL) crews.

Most of the basic components can be ordered separately or they can be ordered as assembled vaults with covers.

This standard applies to the SCL stock numbers listed in Section 10.

Standards Coordinator  
Quan Wang

Standards Supervisor  
John Shipek

Unit Director  
Andrew Strong

### 3. Application

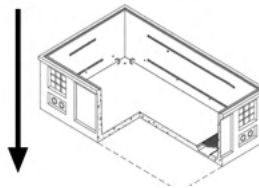
712 vaults are intended for use in the construction of underground electric systems. The precast concrete structure may be used to house medium-sized transformers up to 300 kVA (3 -100 kVA), three-phase load break junction boxes, or service connections and splices for the distribution system.

The standard 712-vault assembly consists of the 712 base [A], a 712 top with two 78-inch by 50-inch block-outs [B1], various risers to bring access opening to grade, a cover with two 3- by 3-foot non-slip, solid hatches and a 42-inch entry access.

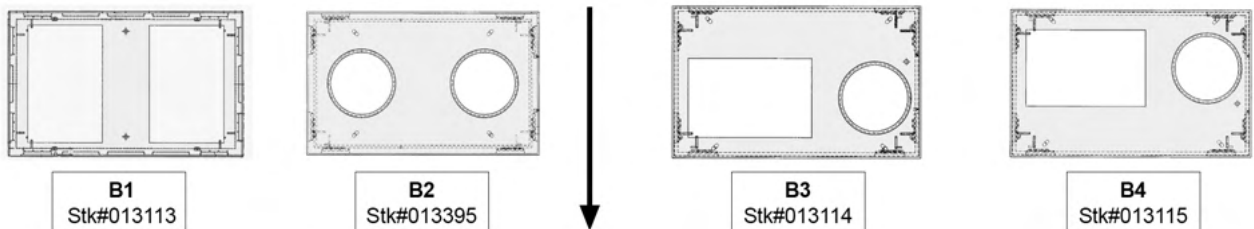
Due to different applications, the vault may need to be customized with different block-out configurations; various risers and access openings (see Figure 3).

#### Figure 3. Steps for selecting the proper vault assembly for your application:

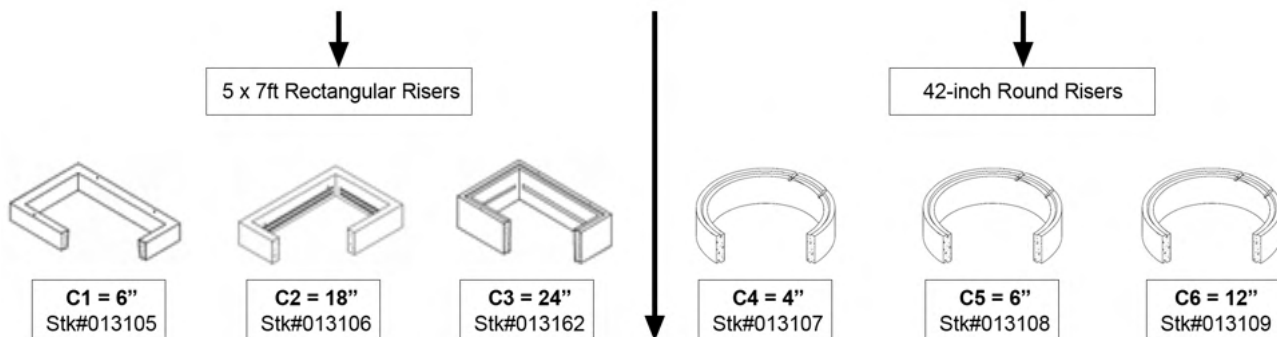
**Step 1.** Select standard 712-vault base, [A] (Stock Number 013112, see section 5).



**Step 2.** Determine and select the type of blockout configuration needed for the vault top section [B#]. There are 4 possible options for the 712 top sections; each allowing a different set of access openings. (Stock Numbers 013113, 013114, 013395, or 013115, see section 6).

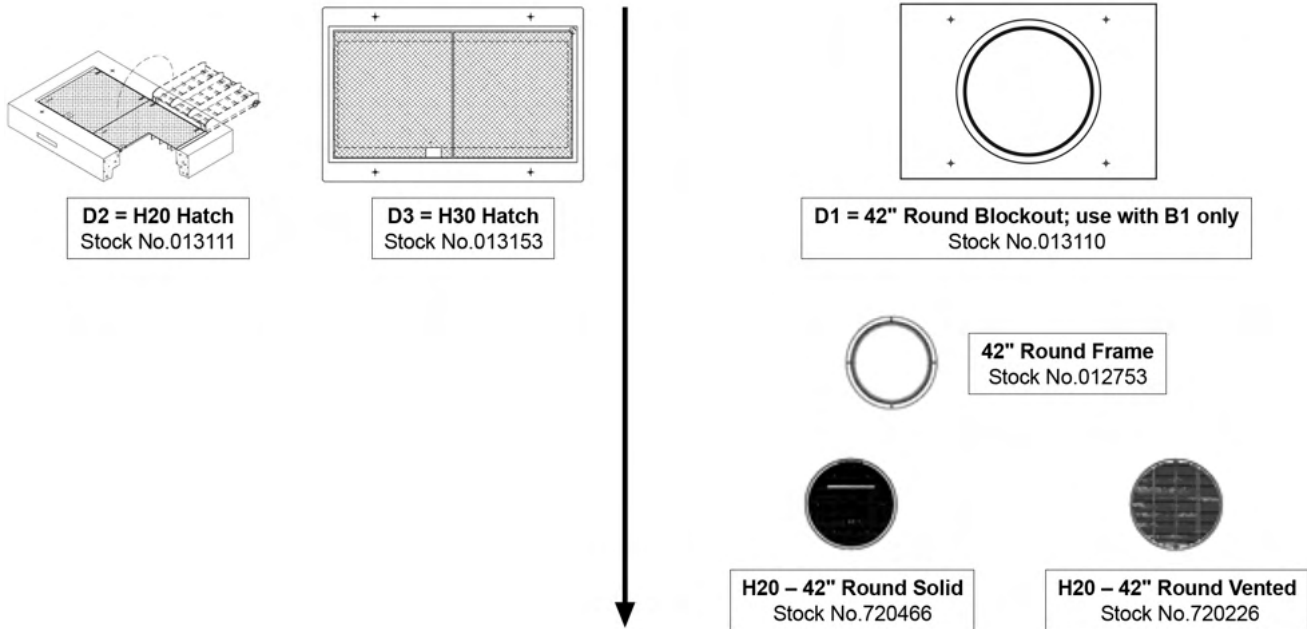


**Step 3.** Select appropriate risers [C#] to bring access opening up to grade. Each riser section for the 712 covers half of the top section. (Stock numbers 013105, 013106, 013162, 013107, 013108, and 013109)

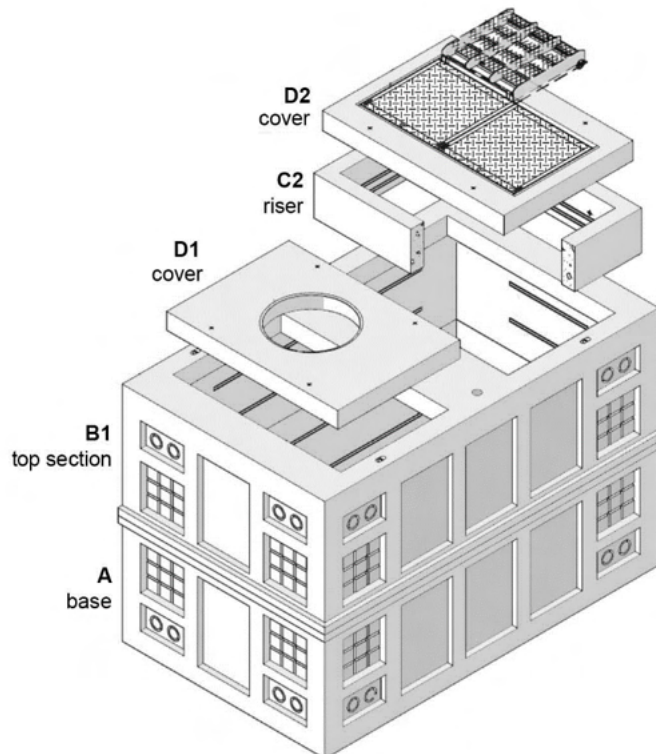




**Step 4. Determine the appropriate type of covers and lids or hatches [D#]**



**Step 5. Check the assembled vault configurations in section 8 for vaults that can be ordered configured with base, top section, and cover. Assembled option will still require choices for risers and hatches or lids.**



**4. General Requirements**

This detailed standard is to be used in conjunction with SCL Material Standard 7203.21, "Precast Reinforced Concrete Structures – General".

Vault grounding shall conform to SCL Material Standard 7203.21, Section 9, Grounding.

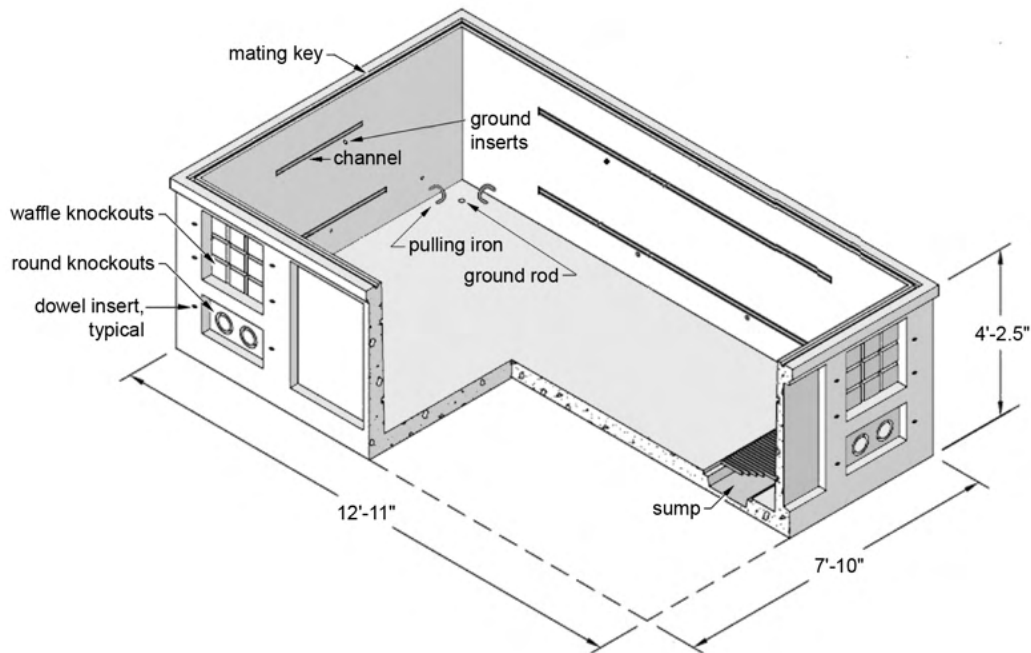
**5. Vault Base Requirements [A]**

All 712 vault bases shall conform to the dimensions cited in Table 5a and Figure 5.

**Table 5a. Nominal Base Dimensions**

Stock No.	Outside (ft-in)		Inside (ft-in)		Height (ft-in)		Figure No.
	Length	Width	Length	Width	Outside	Inside	
013112	12-11	7-10	12-3	7-2	4-2.5	3-9	5

**Figure 5. Standard 712 vault base [A]**



**Table 5b. Vault Base Attributes**

All standard 712 vault bases shall have the following features:

	Size, Nominal (in)	Location	Per Location	Total Number
<b>Knockouts</b>				
Round	4-3/4 dia	All 4 walls, on bottom corners of wall	4 ea side	16
Waffle, 9 - 6 in squares	18 x 18	All 4 walls, above round knockouts	2 ea side	8
Ground rod	2 dia	4 corners of floor	1 ea	4
<b>Channels</b>				
Galvanized "C" channel, horizontal, embedded in walls	36 length	End walls, 9 inches above floor, between knockouts, 22.5 inches on center between channels.	2 ea side	4
	96 length	Side walls, 9 inches above floor between knockouts, 22.5 inches on center between channel	2 ea side	4
Sump with galvanized grate	12 x 60	Floor, about 1 foot from and parallel to short wall	1	1
Pulling irons	7/8 dia	2 each corner of floor (typical)	2 ea corner	8
Ground inserts, bronze	1/2 dia	Side walls, 4 inches below top channel, internal and external	2 ea side	4
Dowel Inserts	1/2 dia	12 inches on center; around the perimeter of duct knockout		
Ladder		Not required		

**6. Top Section Requirements [B1, B2, B3, B4]**

All 712 top sections shall conform to the dimensions cited in Table 6a and Figure 6a.

**Table 6a. Nominal Top Section Dimensions**

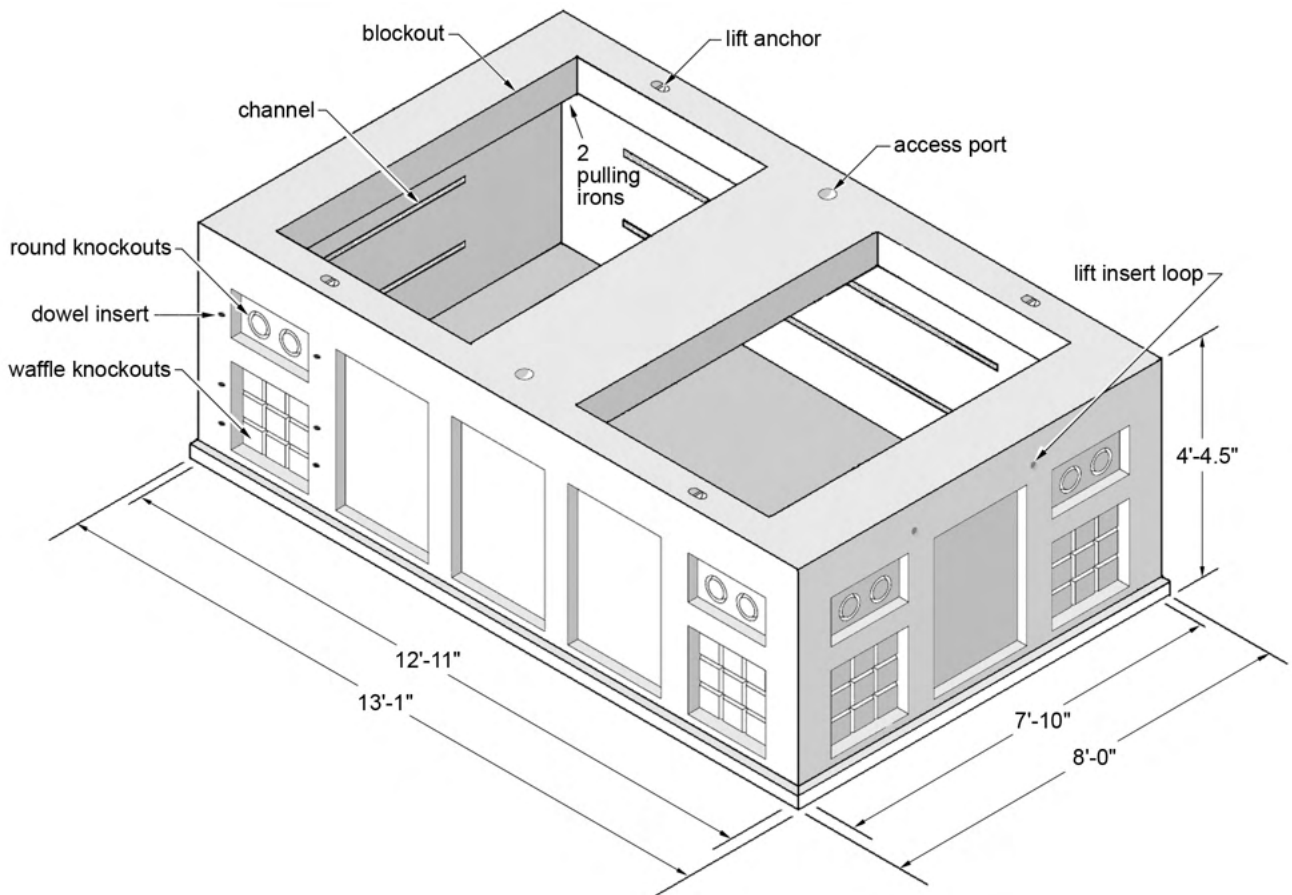
Stock No.	Outside (ft-in)		Inside (ft-in)		Height (ft-in)		Blockout Configurations	Figure
	Length	Width	Length	Width	Outside	Inside		
013113	12-11	7-10	12-3	7-2	4-4.5	3-9	two 78-in by 50-in blockouts	6b, [B1]
013395	12-11	7-10	12-3	7-2	4-4.5	3-9	two 42-in round blockouts	6b, [B2]
013114	12-11	7-10	12-3	7-2	4-4.5	3-9	one 78-in by 50-in blockout and one 42-in round blockout, offset to left (Type 1) [B3]	6b, [B3]
013115	12-11	7-10	12-3	7-2	4-4.5	3-9	one 78-in by 50-in blockout and one 42-in round blockout, offset to right (Type 2) [B4]	6b, [B4]

Notes:

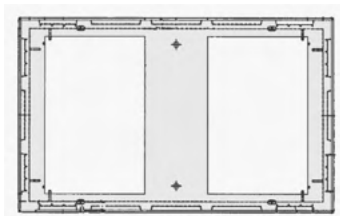
**Type 1** refers to a left-offset rectangular blockout from point-of-view of round blockout end.

**Type 2** refers to a right-offset rectangular blockout from point-of-view of round blockout end.

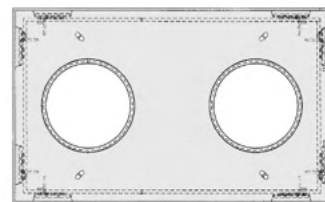
**Figure 6a. Vault top section [B1]**



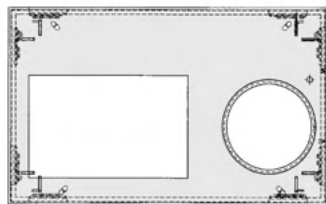
**Figure 6b. Vault top section blockout options (top view)**



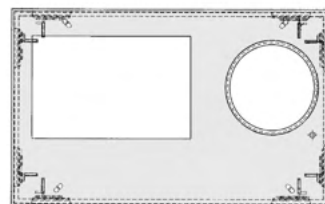
**B1**  
 Stock No. 013113



**B2**  
 Stock No. 013395  
 (not available on separate order)



**B3**  
 Stock No. 013114



**B4**  
 Stock No. 013115

**Table 6b. Top Section Attributes Required**

	Size, Nominal (in)	Location	Per Location	Total Number
<b>Knockouts</b>				
round	4-3/4 dia	all 4 walls, on top corners of wall	4 ea side	16
waffle, 9 - 6 in squares	18 x 18	all 4 walls, below round knockouts	2 ea side	8 waffles
<b>Channels</b>				
galvanized "C" channel, horizontal, embedded in walls	36 length	end walls, 11.25-inches from ceiling, between knockouts, 22.5-inches on center between channels.	2 ea side	4
	96 length	side walls, 11.25-inches from ceiling, between knockouts, 22.5-inches on center between channels	2 ea side	4
<b>Access Port</b>				
<b>[B1]</b>	3 dia	1 each side on top, centered along length of top	1 ea side	2
<b>[B2]</b>	3 dia	1 each side on top, centered along length of top	1 ea side	2
<b>[B3]</b>	3 dia	1, right of 42-inch blockout	1 side	1
<b>[B4]</b>	3 dia	1, left of 42-inch blockout	1 side	1
Pulling irons	7/8 dia	2 ea corner of ceiling (typical)	2 ea corner	8
Lift anchor	6-1/4	4-ton anchor, 1 each corner on top	1 ea corner	4
Lift insert loop	3/4 dia	2 each on outside of one end wall, above knockouts	2, one side	2
Ground inserts, bronze	1/2 dia	side walls, 4 inches below top channel, internal and external	2 ea side	4
Dowel Inserts	1/2 dia	12-Inch on center; around the perimeter of duct knockout		

**7. Covers, Risers and Hatches**

For detailed material standard of covers and risers used with the 712 vault, refer to the latest version of SCL Material Standard 7204.15, "Covers and Risers for Electric Vaults."

All hinged hatches shall open 180 degrees, or flat.

For detailed material standard of 42-inch round cover and frames, refer to the latest version of SCL Material Standard 7204.70, "Frame and Covers, 42-Inch Round, Iron."

**Table 7. Covers, Risers and Hatches**

<b>Stock No.</b>	<b>Description</b>	<b>Mtl. Std.</b>	<b>References to Figure 3</b>
013105	5- by 7-foot by 6-inch riser without galvanized "C" channel	7204.15	<b>C1</b>
013106	5- by 7-foot by 18-inch riser with galvanized "C" channels	7204.15	<b>C2</b>
013362	5- by 7-foot by 24-inch riser with galvanized "C" channels	7204.15	<b>C3</b>
013107	42-inch diameter by 4-inch high round riser	7204.15	<b>C4</b>
013108	42-inch diameter by 6-inch high round riser	7204.15	<b>C5</b>
013109	42-inch diameter by 12-inch high round riser	7204.15	<b>C6</b>
013110	5- by 7-foot cover with one 42-inch round access opening	7204.15	<b>D1</b>
013111	5- by 7-foot adjustable cover with two 3- by 3-foot non-slip solid hatches	7204.15	<b>D2</b>
012753 and 720466	42-inch frame with 42-inch solid cover	7204.70	
012753 and 720226	42-inch frame with 42-inch grated vent cover	7204.70	

**8. Vault Assembly and Packaging**


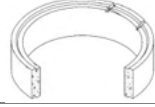
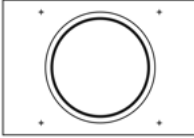


The vault base and the vault top section shall have keyways for proper assembly.

Vault assemblies shall be delivered fully assembled, unless otherwise requested in purchase order.

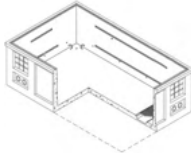

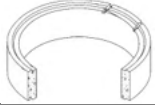
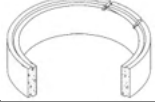


Vaults shall be delivered to the job site, unless otherwise requested in purchase order.

Refer to Tables 8a, 8b, 8c and 8d for the various components included in each vault assembly.

**Table 8a. 712 Vault Assembly 013116: With 1 Equip. (72 in x 36 in) and 1 Personnel (42-in Round Hatch) [A-B1]**

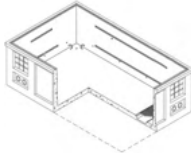

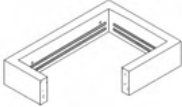
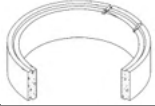

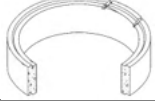



Component	Description	Label	Stock No.	Quantity	Figure
Base		A	013112	1	
Top Section	712 with 2 rectangular blockout	B1	013113	1	
Rectangular Riser	18 in	C2	013106		
42-in Round Riser	4 in	C4	013197	1	
42-in Round Riser	12 in	C6	013109	1	
42-in Round Blockout		D1	013110	1	
Cover with H20 Hatch		D2	013111		
42-in H20 Frame			012753	1	
42-in Solid			720466	1	

**Table 8b. 712 Vault Assembly 013117, With 2 Personnel (42-in Round Hatch) [A-B2]**

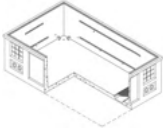

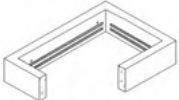

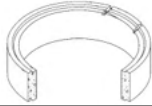
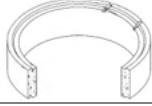


Component	Description	Label	Stock No.	Quantity	Figure
Base		A	013112	1	
Top Section	712 with 2 42-in round blockout	B2	013395	1	
42-in Round Riser	4 in	C4	013107	2	
42-in Round Riser	12 in	C6	013109	2	
42-in H20 Frame			012753	2	
42-in Solid			720466	2	



**Table 8c. 712 Vault Assembly 013118, With 1 Equip. (72 in by 36 in) and 1 Personnel (42-in Round) Hatch, Offset Left (Type 1); [A-B3]**

Component	Description	Label	Stock No.	Quantity	Figure
Base		A	013112	1	
Top section	712 with rectangular and 42-inch round blockout	B3	013114	1	
Rectangular Riser	18 in	C2	013106	1	
42-in Round Riser	4 in	C4	013107	1	
42-in Round Riser	6 in	C5	013108	1	
42-in Round Riser	12 in	C6	013109	1	
Cover with H20 Hatch		D2	013111	1	
42-in H20 Frame			012753	2	
42-in Solid			720466	2	

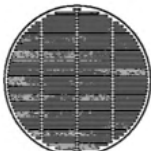
**Table 8d. 712 Vault Assembly with 1 Equip. (72 in by 36 in) and 1 Personnel (42-in Round) Hatch, Offset Right (Type 2); [A-B4]**

Component	Description	Label	Stock No.	Quantity	Figure
Base		A	013112	1	
Top Section	712 with rectangular and 42-in blockout	B4	013115	1	
Rectangular Riser	18 in	C2	013106	1	
42-in Round Riser	4 in	C4	013107	1	
42-in Round Riser	6 in	C5	013108	1	
42-in Round Riser	12 in	C6	013109	1	
Cover with H2O Hatch		D2	013111	1	
42-in H2O Frame			012753	2	
42-in Solid			720466	2	

Notes:

Re: Stock No. 013117, if having the flexibility to convert the access cover from equipment to personnel is desirable, use top section Stock No. 013113 with 2 each of Stock No. 013110 instead of top section Stock No. 013395.

Re: Stock No 720226, if vault contains more than 75 kVA of transformer capacity, a vented (grate) cover is required, per below:

Stock No.	Description	Figure
720226	42-in H2O vented cover	

**9. Issuance**

Stock Unit: EA

**10. Approved Manufacturers**

Stock No.	Components	Label	Catalog Number
			Old Castle/Utility Vault
013116	712 vault with one 72-inch by 36-inch and one 42-inch round entry access	[A-B1]	712 CLX Vault Assembly
013117	712 vault with two 42-inch round entry access	[A-B2]	712 TEE CLX Assembly w/ (2) 57-CLX-42C covers
013118	712 vault with one 72-inch by 36-inch and one 42-inch round entry access, offset to left (Type 1)	[A-B3]	712-CLX Type 1 Vault Assembly
013119	712 vault with one 72-inch by 36-inch and one 42-inch round entry access, offset to right (Type 2)	[A-B4]	712-CLX Type 2 Vault Assembly
013112	712 vault base	[A]	712 Vault Base
013113	712 top with two 78-inch by 50-inch blockouts	[B1]	712-TEE-CLX
013395	712 top with two 42-inch blockouts	[B2]	712-TL-42EE
013114	712 top with one 78-inch by 50-inch blockout and one 42-inch round blockout, offset to left (Type 1)	[B3]	712 TEE CLX Top – Type 1
013115	712 top with one 78-inch by 50-inch blockout and one 42-inch round blockout, offset to right (Type 2)	[B4]	712 TEE CLX Top – Type 2

**11. References**

**SCL Material Standard 7203.21;** “Precast Reinforced Concrete Structure, General”

**SCL Material Standard 7204.15;** “Covers and Risers for Electric Vaults”

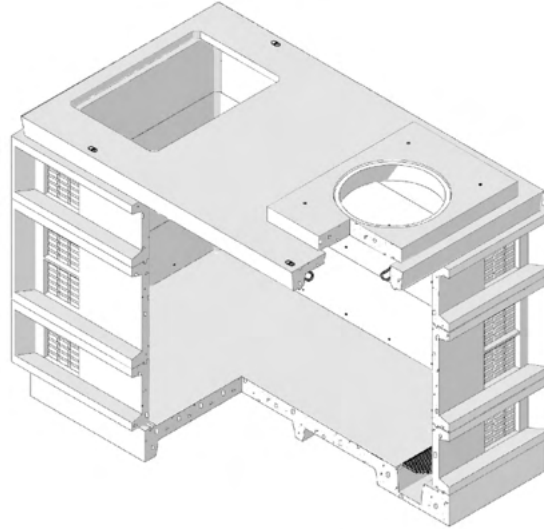
**SCL Material Standard 7204.70;** “Frames and Covers, 42-Inch Round, Iron”

**Detter, Chris;** SCL Distribution Engineer and subject matter expert for 7203.46  
 (chris.detter@seattle.gov)

**Ng, Sharon;** SCL Civil Engineer and subject matter expert for 7203.46  
 (sharon.ng@seattle.gov)

**Wang, Quan;** SCL Standards Engineer, subject matter expert and originator of 7203.46  
 (quan.wang@seattle.gov)

## 814 Electric Vault, Primary Service



### 1. Table of Contents

2. Scope .....	1
3. Application .....	2
4. General Requirements .....	5
5. Base Requirements .....	5
6. Center Section Requirements .....	6
7. Top Section Requirements .....	7
8. Covers, Risers, and Hatches .....	9
9. Vault Assemblies .....	10
10. Shipping .....	25
11. Issuance .....	25
11. Approved Manufacturers .....	26
12. References .....	27
13. Sources .....	27

### 2. Scope

This standard covers the requirements for 814 electrical ring vault components (vault base, center sections (risers) and top sections) and assembled 814 electric vaults.

Most of the basic components can be ordered separately or they can be ordered as assembled vaults with covers.

This standard applies to the Seattle City Light (SCL) stock numbers listed in Section 12.

Due to their size, 814 vaults, components, and accessories will not be stocked in SCL inventory. Engineers and the Civil Crew Chief are required to order and specify delivery of these items.

Standards Coordinator  
 Quan Wang

Standards Supervisor  
 John Shipek

Unit Director  
 Andrew Strong

### 3. Application

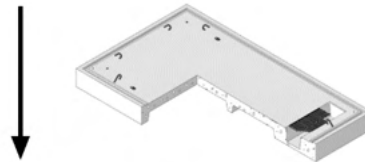
814 vaults are used to construct the underground electric system. This precast concrete vault may be used to house medium size transformers up to 501 kVA, three-phase load break junction boxes, and service connections and splices for the distribution system.

The standard 8-ft high 814-vault assembly consists of the 814 vault base, two 48-in center sections (risers), a 814 top section with two 78-in by 50-in blockouts, various additional risers to bring access opening to grade, a cover with two 3-ft by 3-ft non-slip, solid hatches and a 42-inch entry access.

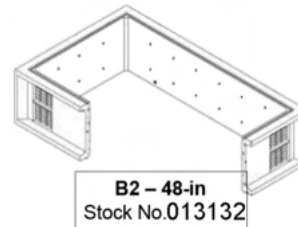
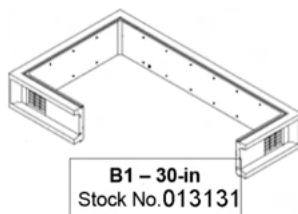
Due to different applications, the vault may need to be customized with tops with different block-out configurations, different combinations of center sections, various risers and access openings (see Figure 3).

**Figure 3. Steps for selecting the proper vault assembly for your application:**

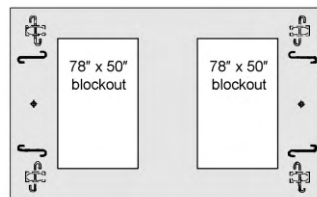
**Step 1.** Select standard 814 vault **base, [A]** (Stock No. 013130, Section 5).



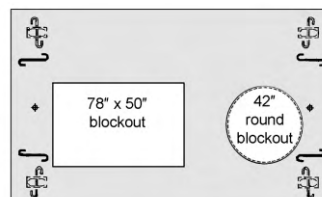
**Step 2.** Determine the height of vault needed, select any combination of 30-in **[B1]** or 48-in **[B2]** center sections (Stock Nos. 013131 and 013132, Section 6)



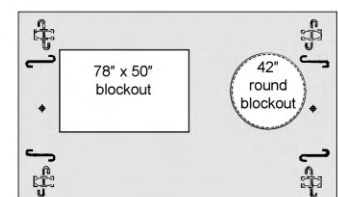
**Step 3.** Determine and select the type of blockout configuration needed for the vault **top section, [C1, C2 and C3]**. For the 814 top sections there are 4 possible options each allowing a different set of access openings. Note, the top section allowing for two 42-in round access openings is not an option to be ordered separately but can be ordered as part of an assembly. Three top sections can be ordered separately. (Stock Nos. 013133, 013134 or 013135, Section 7).



**C1**  
Stk#013133

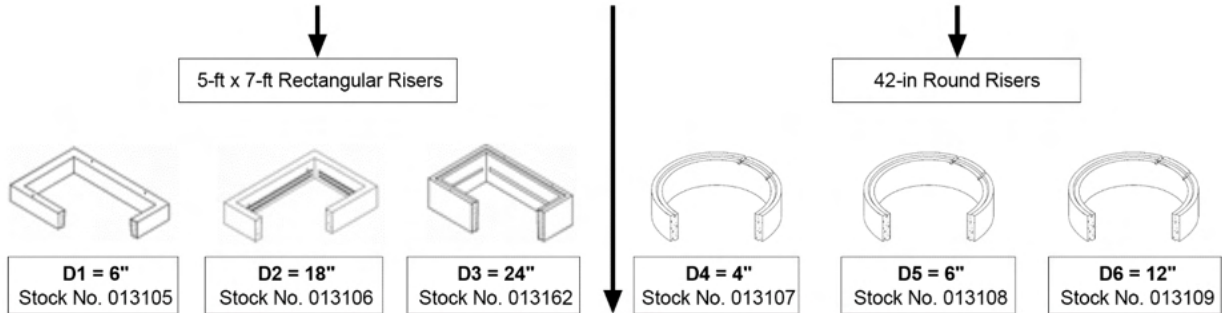


**C2**  
Stk#013134

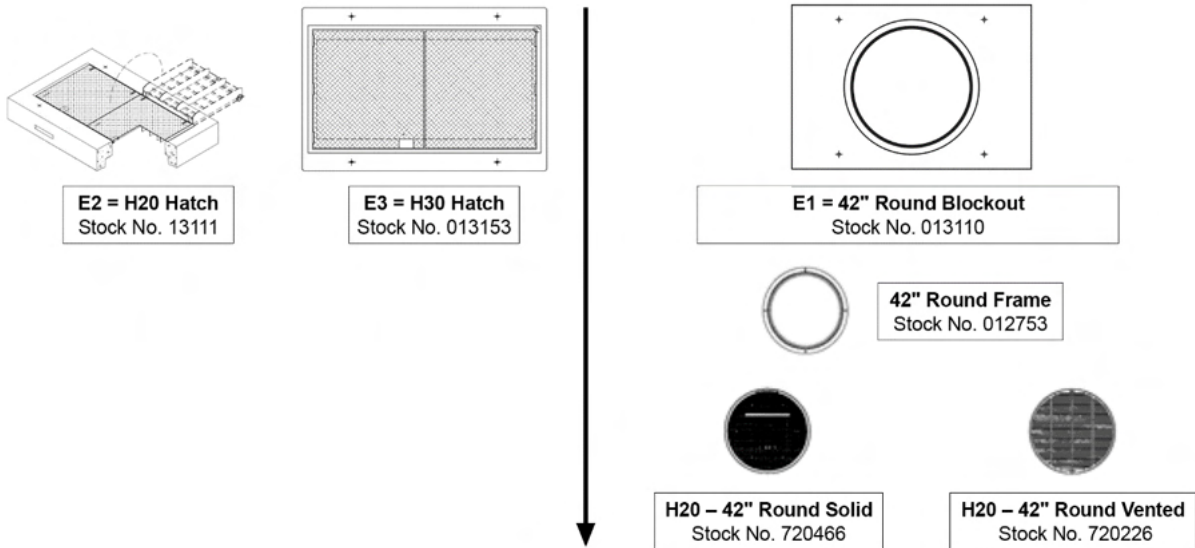


**C3**  
Stk#013135

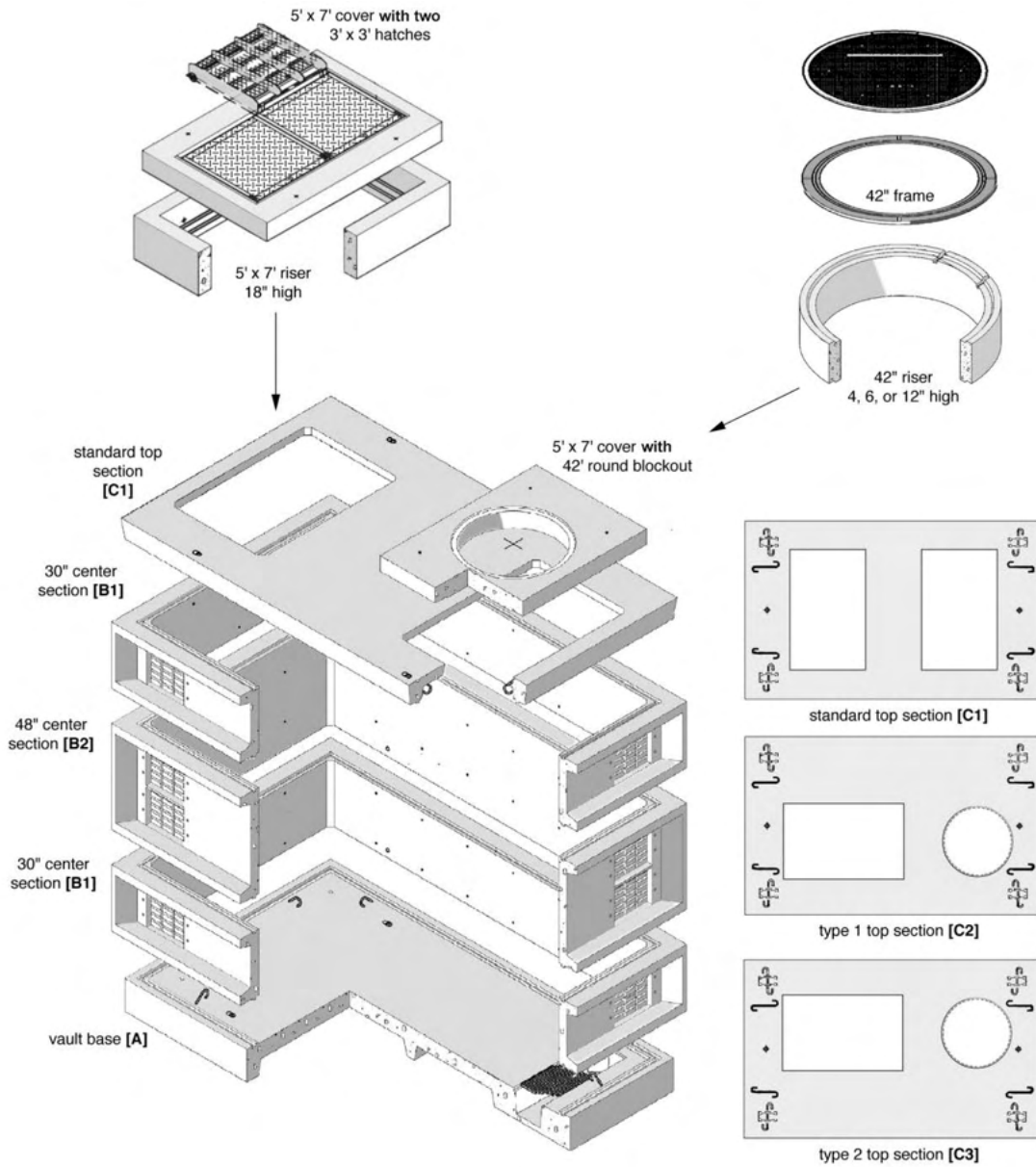
**Step 4.** Select appropriate risers [D#] to bring access opening up to grade. Each riser section for the 814 covers half of the top section. (Stock Nos. 013105, 013106, 013162, 013107, 013108, and 013109).



**Step 5.** Determine the appropriate type of covers and lids or hatches [E#]



**Step 6.** Check the assembled vault configurations in Section 9 for vaults that can be ordered configured with base, top section, and covers. Assembled option will still require choices for risers and hatches or lids.



#### 4. General Requirements

This standard is to be used in conjunction with SCL 7203.21, "Precast Reinforced Concrete Structures – General".

Vault grounding shall conform to SCL 7203.21, Section 9, Grounding.

Typical load rating for ring vaults is H-20; however, if heavy traffic is anticipated, engineer should request an H-25 load rating.

#### 5. Base [A] Requirements

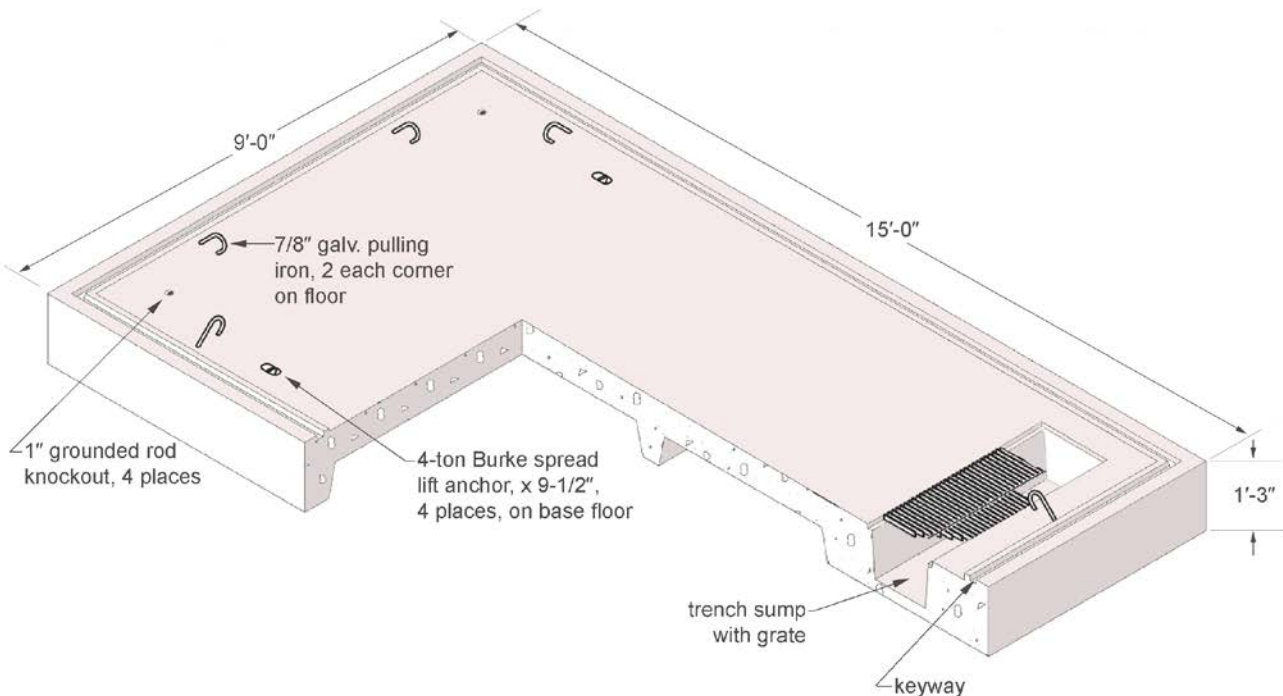
All 814 ring vault bases shall be constructed according to the dimensions shown in Table 5 and Figure 5.

The ring vault floor shall be sloped to drain toward the sump.

**Table 5. Nominal Base Dimensions**

Stock No.	Outside (ft-in)		Inside (ft-in)		Height (ft-in)		Figure
	Length	Width	Length	Width	Outside	Inside	
013130	15-0	9-0	14-0	8-0	1-3	-	5

**Figure 5. Standard Vault Base [A]**



All 814 ring vault base shall have the following attributes:

- Ground rod knockout (1 inch diameter) at each corner of floor
- Trench sump with removable galvanized grating (12 in x 60 in); 1 ft from, and parallel to, short wall
- Pulling iron (7/8 in diameter); two (2) shall be located at each corner of floor, recessed in floor
- 4-ton lift anchors, one on each corner of floor
- Ground inserts (1/2 in) on opposite end walls on the floor
- Ladder; as required if vault floor is 12 ft-6 in or more below finish grade; fixed ladders shall be per SCL drawing D-28304; ladder substitution shall be submitted for approval



**6. Center Section (Riser) Requirements [B1, B2]**

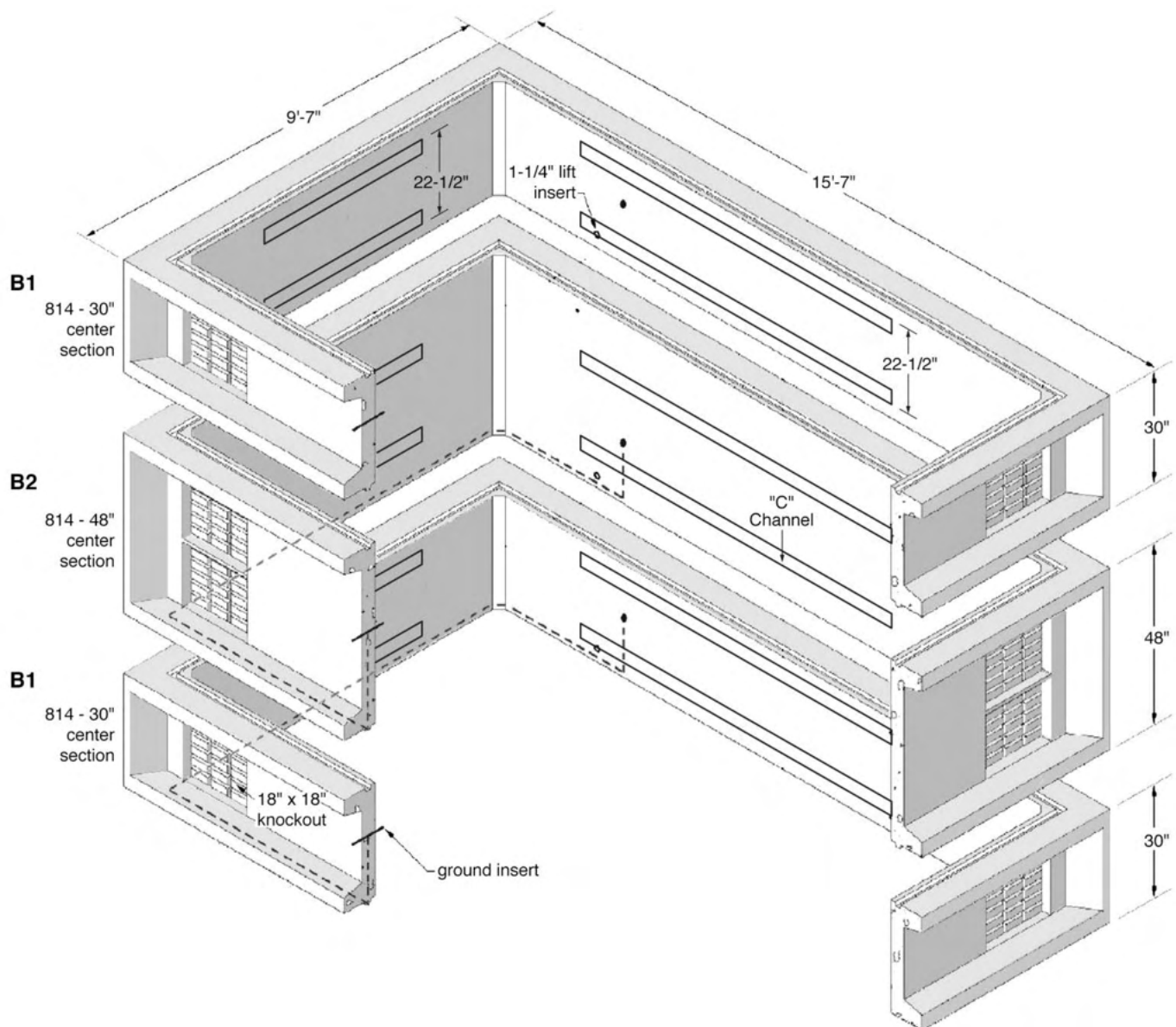
All 814 ring vault center sections shall be constructed according to the dimensions shown in Table 6.

**Table 6. Vault Nominal Center Sections Dimensions**

Stock No.	Outside (ft-in)		Inside (ft-in)		Height (ft-in)		Figure
	Length	Width	Length	Width	Outside	Inside	
013131	15-7	9-7	14-0	8-0	2-6	-	6 [B1]
013132	15-7	9-7	14-0	8-0	4-0	-	6 [B2]

Note: Center sections are considered to be risers by manufacturers but in this Standard we use the term 'center section' to make a distinction from risers used above the top section for the purpose of adjusting the heights of covers to meet surface elevations (grade).

**Figure 6. Vault Center Sections [B1 and B2]**



### 6.1 Knockouts, Waffle

Knockouts shall be of the waffle type.

For a 30-in high vault section **[B1]** (Stock No. 013131, knockout shall measure 18 in by 18 in. Knockouts shall be located on all 4 walls on the outer edge of the wall, two (2) on each side, for a total of eight (8) knockouts.

For a 48-in high vault section **[B2]** (Stock No. 013132), knockout shall measure 15 in by 18 in. Knockouts shall be located on all 4 walls on the outer edge of the wall, four (4) on each side, for a total of 16 knockouts.

### 6.2 Dowel Inserts

Dowel inserts (duct bank knockout inserts) shall be embedded 12 inches on center, around the perimeter of the knockout. Dowel inserts shall accommodate a 1/2-in diameter threaded rebar or steel dowel.

### 6.3 Channels

Galvanized "C" channels shall be embedded in vault walls between knockouts, centered, with 22.5-in spacing between rows.

Channels shall measure 1-5/8 in by 7/8 in by 48 in on the end walls and 1-5/8 in by 7/8 in by 120 in on the side walls.

### 6.4 Lift Inserts

Lift inserts shall measure 1 inch in diameter. These shall be located on wall ends, along the bottom of the side walls, between knockouts.

### 6.5 Ground Inserts

Material shall be bronze. Ground inserts shall measure 1/2 inch in diameter. Four (4) total inserts shall be used, two (2) each located at the center of both internal and external side walls.

## 7. Top Section Requirements, [C1], [C2] and [C3]

All 814 top sections shall be constructed according to the dimensions shown in Table 7 and Figures 7a and 7b.

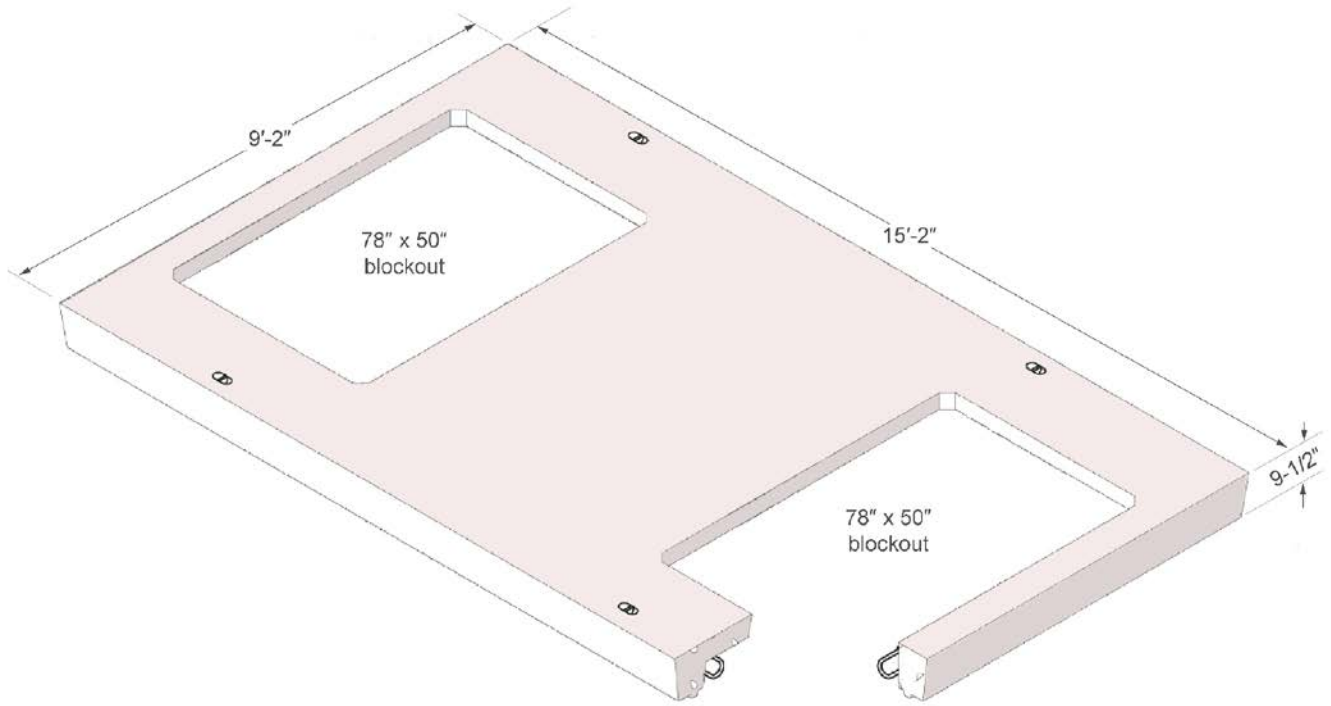
**Table 7. Nominal Top Sections Dimensions and Weight**

Stock No.	Top Sections (ft-in)			Blockout Configurations	Figure
	Length	Width	Thickness (in)		
013133	15-2	9-2	9.5	Two 78-in x 50-in blockouts <b>[C1]</b>	7a & 7b <b>[C1]</b>
013134	15-2	9-2	9.5	One 78-in x 50-in blockouts and one 42-in round blockouts, offset to left (Type 1) <b>[C2]</b>	7a & 7b <b>[C2]</b>
013135	15-2	9-2	9.5	One 78-in x 50-in blockouts and one 42-in round blockouts, offset to right (Type 2) <b>[C3]</b>	7a & 7b <b>[C3]</b>

Notes

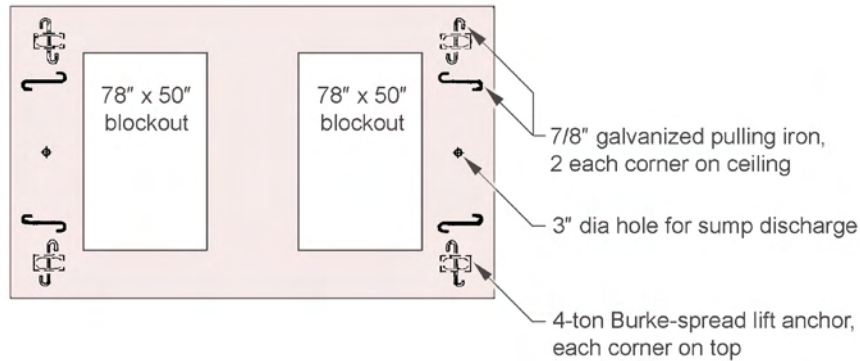
- Type 1** refers to a left-offset rectangular blockout from point-of-view of round blockout end.
- Type 2** refers to a right-offset rectangular blockout from point-of-view of round blockout end.

**Figure 7a. Vault Top Section [C1]**

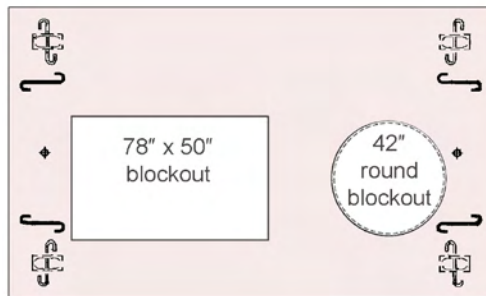


**Figure 7b. Vault Top Section Blockout Options**

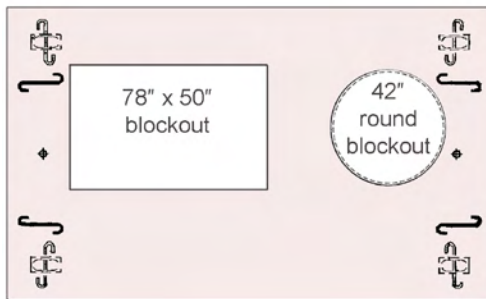
814 Standard Top, Stock No. 013133 [C1]



814 Type 1 Top, Stock No. 013134 [C2], blockout offset to left



814 Type 2 Top, Stock No. 013135 [C3], blockout offset to right



All 814 ring vault top covers shall have the following features:

- Pulling iron (7/8 in diameter); two (2) shall be located at each corner of ceiling
- 4-ton lift anchors, one on each corner of floor
- One access port (3 in diameter) shall be located at the center of each ends of top cover

## 8. Covers, Risers, and Hatches

Risers described in this section are designed to be set on the vault top section or on the cover for the purpose of adjusting the height of the vault access entrance to meet surface elevations (grade).

For a detailed material standard for covers and risers used with the 814 vault, refer to SCL 7204.15, "Covers and Risers for Electric Vaults."

For a detailed material standard for 42-inch round cover and frames, refer to SCL 7204.70, "Frame and Covers, 42-Inch Round, Iron."

**Table 8. Covers, Risers, and Hatches**

Stock No.	Description	Matl. Std.	References to Figure 3
013105	5-ft x 7-ft x 6-in riser without galvanized "C" channel	7204.15	D1
013106	5-ft x 7-ft x 18-in riser with galvanized "C" channels	7204.15	D2
013362	5-ft x 7-ft x 24-in riser with galvanized "C" channels	7204.15	D3
013107	42-in diameter by 4-in high round riser	7204.15	D4
013108	42-in diameter by 6-in high round riser	7204.15	D5
013109	42-in diameter by 12-in high round riser	7204.15	D6
013110	5-ft x 7-ft cover with one 42-in round access opening	7204.15	E1
013111	5-ft x 7-ft adjustable cover with two 3-ft x 3-ft non-slip solid hatches	7204.15	E2
013153	5-ft x 7-ft cover with two H-30 solid hatches	7204.15	E3
012753 and 720466	42-in frame with 42-in solid cover	7204.70	
012753 and 720226	42-in frame with 42-in grated vent cover	7204.70	

**Rectangular blackout:** For all top sections with rectangular openings covers are necessary, one for each top section rectangular blackout. Covers may either be set directly on the top section or may be set on risers. Covers shall be produced with a key shape on the bottom to fit into the 8-ft x 4 ft-6 in opening in the top section or in the riser openings. Risers are used to obtain the required elevation and then topped by the covers. In that case the risers are set with the blackout hole in the top section matching the opening of the risers (the openings have the same dimension). No key system is required to mate the rectangular riser to the top section.

**Round blackout:** Covers with 42-in round access holes may be set in grout directly on the top section surface. Keyed round risers may also be set directly into top sections that have 42-in round blockouts. Round risers shall have keys that are matched in the top covers with round blockouts; the same type of matching keys are required in covers with round blockouts.

## 9. Vault Assemblies

Seattle City Light has specified fourteen 814 vault assemblies that can be ordered by stock number. The predefined assemblies have three interior vault heights of 8, 9, or 10 feet with several options for overall height and type of access openings (see Table 9q).

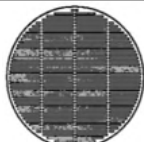
The vault base and the vault top section shall have keyways for proper assembly.

Vaults shall be delivered to the job site, unless otherwise requested in purchase order.


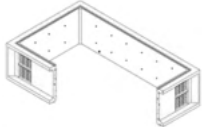

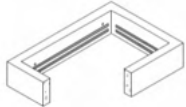
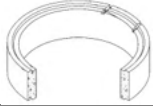



Refer to Tables 9a – 9p for the various components included in each vault assemblies.

For all vault assemblies, if vault contains more than 75 kVA of transformer capacity, a vented (grate) cover (Stock No. 720226) is required in place of the solid cover (Stock No. 720466) per Table 9a.


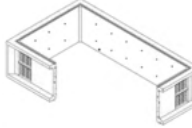

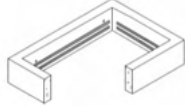
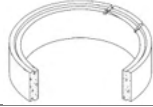
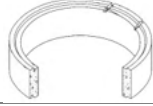
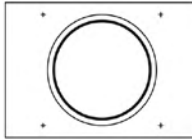
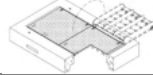
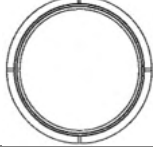

**Table 9a. 42-in Vented Cover**

Stock No.	Description	Figure
720226	42-in H20 vented cover	

**Table 9b. 8-ft Vault Assembly 013136: With 1 Equip. (72 in x 36 in) and 1 Personnel (42-in Round Hatch) [A-C1]**

Component	Description	Label	Stock No.	Quantity	Figure
Base		A	013130	1	
Mid-Section Riser	48 in	B2	013132	2	
Top Section	814 with 2 rectangular blockout	C1	013133	1	
Rectangular Riser	18 in	D2	013106	1	
42-in Round Riser	4 in	D4	013197	1	
42-in Round Riser	12 in	D6	013109	1	
42-in Round Blockout		E1	013110	1	
Cover with H20 Hatch		E2	013111	1	
42-in H20 Frame			012753	1	
42-in Solid			720466	1	

**Table 9c. 8-ft Vault Assembly 013137: With 1 Equip. (72 in x 36 in) and 1 Personnel (42-in Round Hatch) (Type 1); [A-C2]**

Component	Description	Label	Stock No.	Quantity	Figure
Base		A	013130	1	
Mid-Section Riser	48 in	B2	013132	2	
Top Section	814 with rectangular and 42-inch round blockout, Type 1, offset to left	C2	013134	1	
Rectangular Riser	18 in	D2	013106	1	
42-in Round Riser	4 in	D4	013197	1	
42-in Round Riser	12 in	D6	013109	1	
42-in Round Blockout		E1	013110	1	
Cover with H20 Hatch		E2	013111	1	
42-in H20 Frame			012753	1	
42-in Solid			720466	1	

**Table 9d. 8-ft Vault Assembly 013138: With 1 Equip. (72 in x 36 in) and 1 Personnel (42-in Round Hatch) (Type 2); [A-C3]**



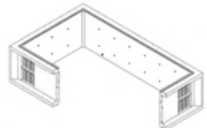



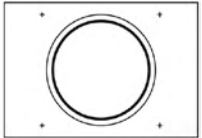


Component	Description	Label	Stock No.	Quantity	Figure
Base		A	013130	1	
Mid-Section Riser	48 in	B2	013132	2	
Top Section	814 with rectangular and 42-in round blockout, Type 2, offset to right	C3	013135	1	
Rectangular Riser	18 in	D2	013106	1	
42-in Round Riser	4 in	D4	013197	1	
42-in Round Riser	12 in	D6	013109	1	
42-in Round Blockout		E1	013110	1	
Cover with H2O Hatch		E2	013111	1	
42-in H2O Frame			012753	1	
42-in Solid			720466	1	







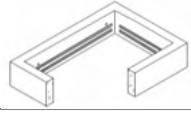

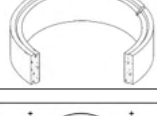
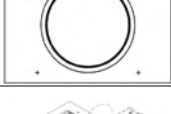
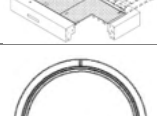


**Table 9e. 9-ft Vault Assembly 013139: With 1 Equip. (72 in x 36 in) and 1 Personnel (42-in Round Hatch) [A-C1]**

Component	Description	Label	Stock No.	Quantity	Figure
Base		A	013130	1	
Mid-Section Riser	30 in	B1	013131	2	
Mid-Section Riser	48 in	B2	013132	1	
Top Section	814 with 2 rectangular blockouts	C1	013133	1	
Rectangular Riser	18 in	D2	013106	1	
42-in Round Riser	4 in	D4	013197	1	
42-in Round Riser	12 in	D6	013109	1	
42-in Round Blockout		E1	013110	1	
Cover with H20 Hatch		E2	013111	1	
42-in H20 Frame			012753	1	
42-in Solid			720466	1	

**Table 9f. 9-ft Vault Assembly 013140: With 2 Personnel (42-in Round Hatch) [A-C1]**

Component	Description	Label	Stock No.	Quantity	Figure
Base		A	013130	1	
Mid-Section Riser	30 in	B1	013131	2	
Mid-Section Riser	48 in	B2	013132	1	
Top Section	814 with 2 rectangular blockouts	C1	013133	1	
42-in Round Riser	4 in	D4	013197	2	
42-in Round Riser	12 in	D6	013109	2	
42-in Round Blockout		E1	013110	2	
42-in H20 Frame			012753	2	
42-in Solid			720466	2	




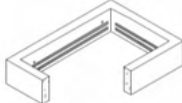


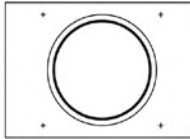
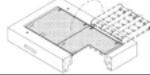
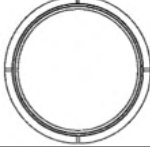

**Table 9g. 814 – 9 ft Vault Assembly 013141: With 1 Equip. (72 in x 36 in) and 1 Personnel (42-in Round Hatch) (Type 1); [A-C2]**

Component	Description	Label	Stock No.	Quantity	Figure
Base		A	013130	1	
Mid-Section Riser	30 in	B1	013131	2	
Mid-Section Riser	48 in	B2	013132	1	
Top Section	814 with rectangular and 42-in round blackout, Type 1, offset to left	C2	013134	1	
Rectangular Riser	18 in	D2	013106	1	
42-in Round Riser	4 in	D4	013197	1	
42-in Round Riser	12 in	D6	013109	1	
42-in Round Blockout		E1	013110	1	
Cover with H20 Hatch		E2	013111	1	
42-in H20 Frame			012753	1	
42-in Solid			720466	1	




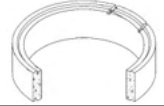
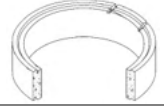
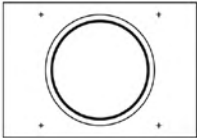


**Table 9h. 9-ft Vault Assembly 013142: With 1 Equip. (72 in x 36 in) and 1 Personnel (42-in Round Hatch) (Type 2); [A-C3]**

Component	Description	Label	Stock No.	Quantity	Figure
Base		A	013130	1	
Mid-Section Riser	30 in	B1	013131	2	
Mid-Section Riser	48 in	B2	013132	1	
Top Section	814 with rectangular and 42-inch round blockout, Type 2, off-set to right	C3	013135	1	
Rectangular Riser	18 in	D2	013106	1	
42-in Round Riser	4 in	D4	013197	1	
42-in Round Riser	12 in	D6	013109	1	
42-in Round Blockout		E1	013110	1	
Cover with H20 Hatch		E2	013111	1	
42-in H20 Frame			012753	1	
42-in Solid			720466	1	



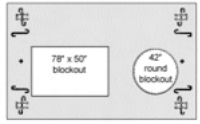
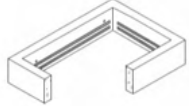

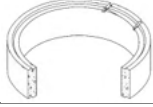
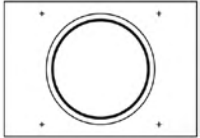

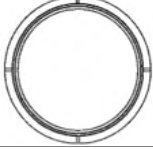

**Table 9i. 10-ft Vault Assembly 013143: With 1 Equip. (72 in x 36 in) and 1 Personnel (42-in Round Hatch) [A-C1]**

Component	Description	Label	Stock No.	Quantity	Figure
Base		A	013130	1	
Mid-Section Riser	30 in	B1	013131	4	
Top Section	814 with 2 rectangular blackout	C1	013133	1	
Rectangular Riser	18 in	D2	013106	1	
42-in Round Riser	4 in	D4	013197	1	
42-in Round Riser	12 in	D6	013109	1	
42-in Round Blockout		E1	013110	1	
Cover with H20 Hatch		E2	013111	1	
42-in H20 Frame			012753	1	
42-in Solid			720466	1	


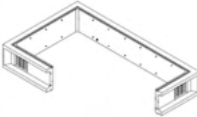

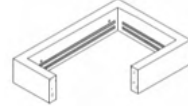

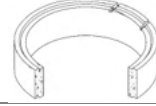
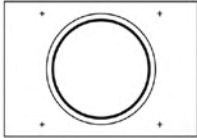
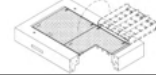
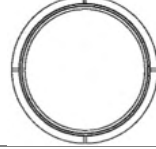

**Table 9j. 10-ft Vault Assembly 013144: With 2 Personnel (42-in Round Hatch) [A-C1]**

Component	Description	Label	Stock No.	Quantity	Figure
Base		A	013130	1	
Mid-Section Riser	30 in	B1	013131	4	
Top Section	814 with 2 rectangular blockout	C1	013133	1	
42-in Round Riser	4 in	D4	013197	2	
42-in Round Riser	12 in	D6	013109	2	
42-in Round Blockout		E1	013110	2	
42-in H20 Frame			012753	2	
42-in Solid			720466	2	

**Table 9k. 10-ft Vault Assembly 013145: With 1 Equip. (72 in x 36 in) and 1 Personnel (42-in Round Hatch) (Type 1); [A-C2]**

Component	Description	Label	Stock No.	Quantity	Figure
Base		A	013130	1	
Mid-Section Riser	30 in	B1	013131	4	
Top Section	814 with rectangular and 42-inch round blockout, Type 1, off-set to left	C2	013134	1	
Rectangular Riser	18 in	D2	013106	1	
42-in Round Riser	4 in	D4	013197	1	
42-in Round Riser	12 in	D6	013109	1	
42-in Round Blockout		E1	013110	1	
Cover with H20 Hatch		E2	013111	1	
42-in H20 Frame			012753	1	
42-in Solid			720466	1	

**Table 9I. 10-ft Vault Assembly 013146: With 1 Equip. (72 in x 36 in) and 1 Personnel (42-in Round Hatch) (Type 2); [A-C3]**


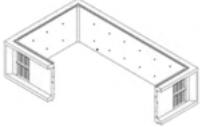
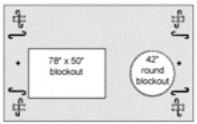
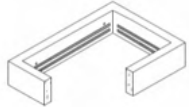
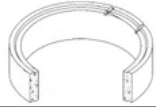
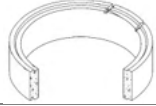
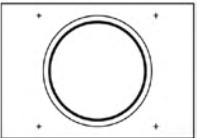
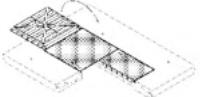


Component	Description	Label	Stock No.	Quantity	Figure
Base		A	013130	1	
Mid-Section Riser	30 in	B1	013131	4	
Top Section	814 with rectangular and 42-inch round blackout, Type 2, offset to right	C3	013135	1	
Rectangular Riser	18 in	D2	013106	1	
42-in Round Riser	4 in	D4	013197	1	
42-in Round Riser	12 in	D6	013109	1	
42-in Round Blockout		E1	013110	1	
Cover with H2O Hatch		E2	013111	1	
42-in H2O Frame			012753	1	
42-in Solid			720466	1	




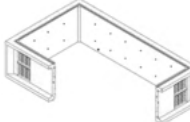
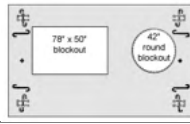
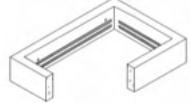


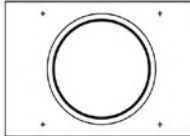
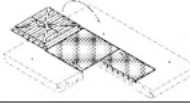


**Table 9m. 8-ft Vault Assembly 013161: With 1 H30 Equip. (72 in x 36 in) and 1 Personnel (42-in Round Hatch) [A-C1]**

Component	Description	Label	Stock No.	Quantity	Figure
Base		A	013130	1	
Mid-Section Riser	48 in	B2	013132	2	
Top Section	814 with 2 rectangular blockout	C1	013133	1	
Rectangular Riser	18 in	D2	013106	1	
42-in Round Riser	4 in	D4	013197	1	
42-in Round Riser	12 in	D6	013109	1	
42-in Round Blockout		E1	013110	1	
Cover with H30 Hatch		E2	013153	1	
42-in H20 Frame			012753	1	
42-in Solid			720466	1	


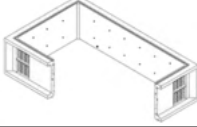

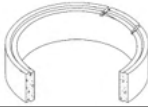
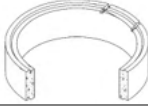
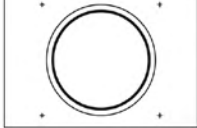

**Table 9n. 8-ft Vault Assembly 013162: With 1 H30 Equip. (72 in x 36 in) and 1 Personnel (42-in Round Hatch) (Type 1); [A-C2]**

Component	Description	Label	Stock No.	Quantity	Figure
Base		A	013130	1	
Mid-Section Riser	48 in	B2	013132	2	
Top Section	814 with rectangular and 42-inch round blackout, Type 1, offset to left	C3	013134	1	
Rectangular Riser	18 in	D2	013106		
42-in Round Riser	4 in	D4	013197	1	
42-in Round Riser	12 in	D6	013109	1	
42-in Round Blockout		E1	013110	1	
Cover with H30 Hatch		E2	013153	1	
42-in H20 Frame			012753	1	
42-in Solid			720466	1	

**Table 9p. 8-ft Vault Assembly 013163: With 1 H30Equip. (72 in x 36 in) and 1 Personnel (42-in Round Hatch) (Type 2); [A-C3]**

Component	Description	Label	Stock No.	Quantity	Figure
Base		A	013130	1	
Mid-Section Riser	48 in	B2	013132	2	
Top Section	814 with rectangular and 42-inch round blackout, Type 2, offset to right	C3	013135	1	
Rectangular Riser	18 in	D2	013106	1	
42-in Round Riser	4 in	D4	013197	1	
42-in Round Riser	12 in	D6	013109	1	
42-in Round Blockout		E1	013110	1	
Cover with H30 Hatch		E3	013153	1	
42-in H20 Frame			012753	1	
42-in Solid			720466	1	

**Table 9q. 8-ft Vault Assembly 014518: With 2 Personnel (42 in Round Hatch) [A C1]**

Component	Description	Label	Stock No.	Quantity	Figure
Base		A	013130	1	
Mid-Section Riser	48 in	B2	013132	2	
Top Section	814 with 2 rectangular blockouts	C1	013133	1	
42-in Round Riser	4 in	D4	013197	2	
42-in Round Riser	12 in	D6	013109	2	
42-in Round Blockout		E1	013110	2	
42-in H20 Frame			012753	2	
42-in Solid			720466	2	

**Table 9r. Vault Assembly Components and Overall Heights and Weight**

Vault Assembly (ft)	Inside Height, Nominal	Outside Height <sup>a</sup> , Nominal	814 – 30R Risers	814 – 48R Risers	Vault Weight <sup>a</sup> , Nominal (lb)
8	8 ft-0 in	10 ft-5 in	-	2	51,700 lb
9	9 ft-0 in	11 ft-5 in	2	1	55,400 lb
10	10 ft-0 in	12 ft-5 in	4	-	59,100 lb

Note

a. Height and weight do not include covers or additional risers to bring access to grade.

## 10. Shipping

All vaults larger than 444 shall be delivered to the job site. Contact SCL civil crew chief to arrange delivery details.

## 11. Issuance

Stock Unit: EA

## 12. Approved Manufacturers

<b>Stock No.</b>	<b>Components</b>	<b>Manufacturer and Catalog No.</b>
		<b>Old Castle/ Utility Vault</b>
013130	Standard vault base [A]	814 – SB
013131	30-in center section [B1]	814-30R w/ GRD
013132	48-in center section [B2]	814-48R w/ GRD
013133	Vault top section with two 76-in x 50-in blockouts [C1]	814-TEE-CLX
013134	Vault top section with one 76-in x 50-in and one 42-in round blockout, offset to left, Type 1 [C2]	814 Type 1 top
013135	Vault top section with one 76-in x 50-in and one 42-in round blockout, offset to right, Type 2 [C3]	814 Type 2 top
	<b>Assemblies</b>	
013136	8-ft high vault with one H-20 72-in x 36-in and one 42-in round entry access	814-8 CLX vault w/ GRD
013137	8-ft high vault with one 72-in x 36-in and one 42-in round entry access, offset to left (Type 1)	814-8 CLX Type 1 vault w/ GRD
013138	8-ft high vault with one 72-in x 36-in and one 42-in round entry access, offset to right (Type 2)	814-8 CLX Type 2 vault w/ GRD
013139	9-ft high vault with one 72-in x 36-in and one 42-in round entry access	814-9 CLX vault w/ GRD
013140	9-ft high vault with two 42-in round entry accesses	814-9 vault w/ 814-TEE-CLX top w/ (2) 42-in access holes w/ GRD
013141	9-ft high vault with one 72-in x 36-in and one 42-in round entry access, offset to left (Type 1)	814-9 CLX Type 1 vault w/ GRD
013142	9-ft high vault with one 72-in x 36-in and one 42-in round entry access, offset to right (Type 2)	814-9 CLX Type 2 vault w/ GRD
013143	10-ft high vault with one 72-in x 36-in and one 42-in round entry access	814-10 CLX vault w/ GRD
013144	10-ft high vault with two 42-in round entry accesses	814-10 vault w/ 814-TEE-CLX top w/ two 42-in access holes w/ GRD
013145	10-ft high vault with one 72-in x 36-in and one 42-in round entry access, offset to left (Type 1)	814-10 CLX Type 1 vault w/ GRD
013146	10-ft high vault with one 72-in x 36-in and one 42-in round entry access, offset to right (Type 2)	814-10 CLX Type 2 vault w/ GRD
013161	8-ft high vault with H-30 LW 2-door hatch and one 42-in round entry access	814-8 CLX vault w/ GRD w/ LW hatch
013162	8-ft high vault with H-30 LW 2-door hatch and one 42-in round entry access, offset to left (Type 1)	814-8 CLX Type 1 vault w/ GRD w/ LW hatch
013163	8-ft high vault with H-30 LW 2-door hatch and one 42-in round entry access, offset to right (Type 2)	814-8 CLX Type 2 vault w/ GRD w/ LW hatch
014518	8-ft high vault with two 42-in round entry accesses	814-8 vault w/ 814-TEE-CLX top w/ two 42-in access holes w/ GRD

### 13. References

**SCL Material Standard 7203.21**; “Precast Reinforced Concrete Structure, General”

**SCL Material Standard 7204.15**; “Covers and Risers for Electric Vaults”

**SCL Material Standard 7204.70**; “Frames and Covers, 42-Inch Round, Iron”

---

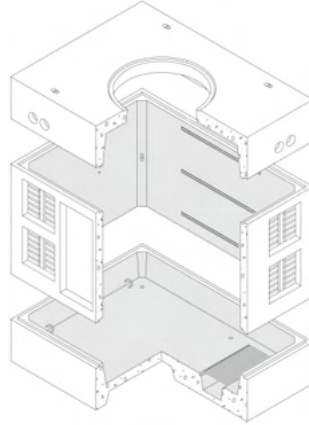
### 14. Sources

**Ng, Sharon**; SCL Civil Engineer and subject matter expert for 7203.51  
(sharon.ng@seattle.gov)

**Wang, Quan**; SCL Standards Engineer, subject matter expert, and originator of 7203.51  
(quan.wang@seattle.gov)

**Youngs, Rob**; SCL Electrical Reviewer and subject matter expert for 7203.51  
(rob.youngs@seattle.gov)

## 687 Electric Vault, Primary Service



### 1. Scope

This standard covers the requirements for 687 electrical vault components (vault base, mid-section, and cover with round access) and assembled 687 electric vaults.

Either separate components or an assembled unit can be ordered.

This standard applies to the following Seattle City Light (SCL) stock numbers:

Stock No.	Description
013734	Base, standard 687
013735	Mid-section
013736	Cover with round access
013737	Assembly (base, mid-section, and cover with round access)

### 2. Application

687 precast concrete vaults are used to construct the underground electric system. The vault may be used to house medium-size transformers, and service connections and splices for the distribution system.

The standard assembly consists of a base, a mid-section, and a cover with one 42-in round access.

A 42-in round iron frame and cover must be ordered separately. For detailed material specifications for the iron frame and cover, see SCL 7204.70, "Frame and Covers, 42-Inch Round, Iron."

H20-rated vault assemblies with rectangular or square hatches should not be used in locations with high-density traffic.

Standards Coordinator  
Quan Wang

Standards Supervisor  
John Shipek

Unit Director  
Darnell Cola

### 3. General Requirements

This standard is to be used in conjunction with SCL 7203.21, "Precast Reinforced Concrete Structures, General."

Vault grounding shall conform to SCL 7203.21, Section 9, "Grounding."

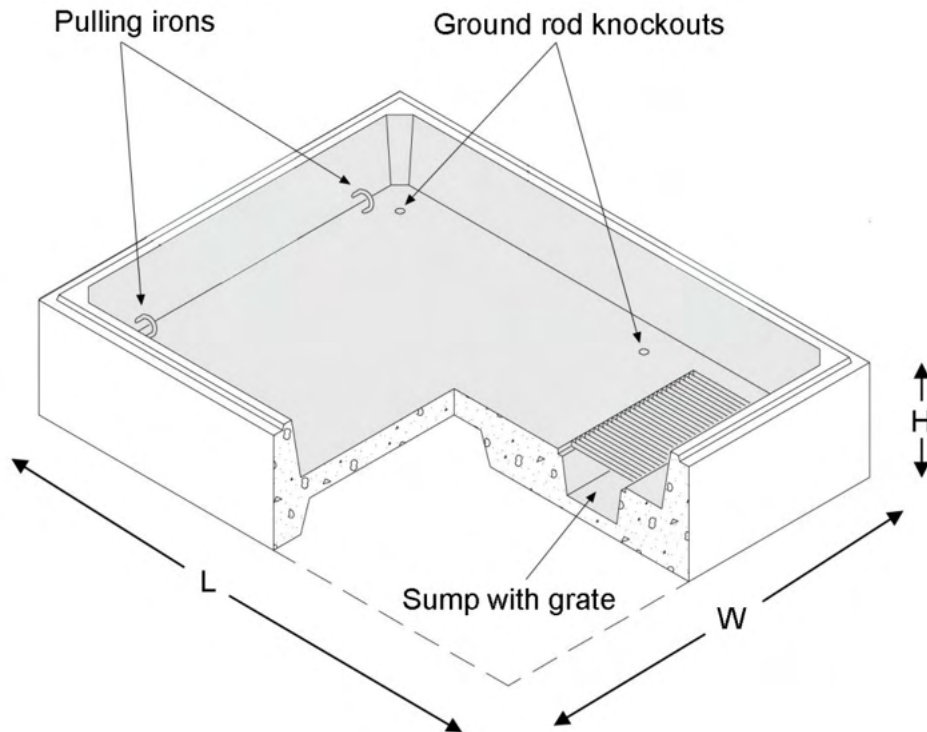
### 4. Base Requirements

The vault base shall be constructed according to the dimensions and details shown in Table 4 and Figure 4.

**Table 4. Base Dimensions (Nominal)**

Stock No.	Outside			Inside		
	Length	Width	Height	Length	Width	Height
013734	8' 8"	6' 8"	1' 10"	8' 0"	6' 0"	1' 0"

**Figure 4. Base**



Vault bases shall have:

- Round rod knockout (1 in diameter) at each corner of the floor.
- Trench sump with removable galvanized grating (12 in x 64 in x 8 in) 1 ft from, and parallel to, the end wall.
- Two pulling irons that are 7/8 in diameter at each end of the floor. 1/2-inch diameter pulling irons shall not be used for 687 vaults.



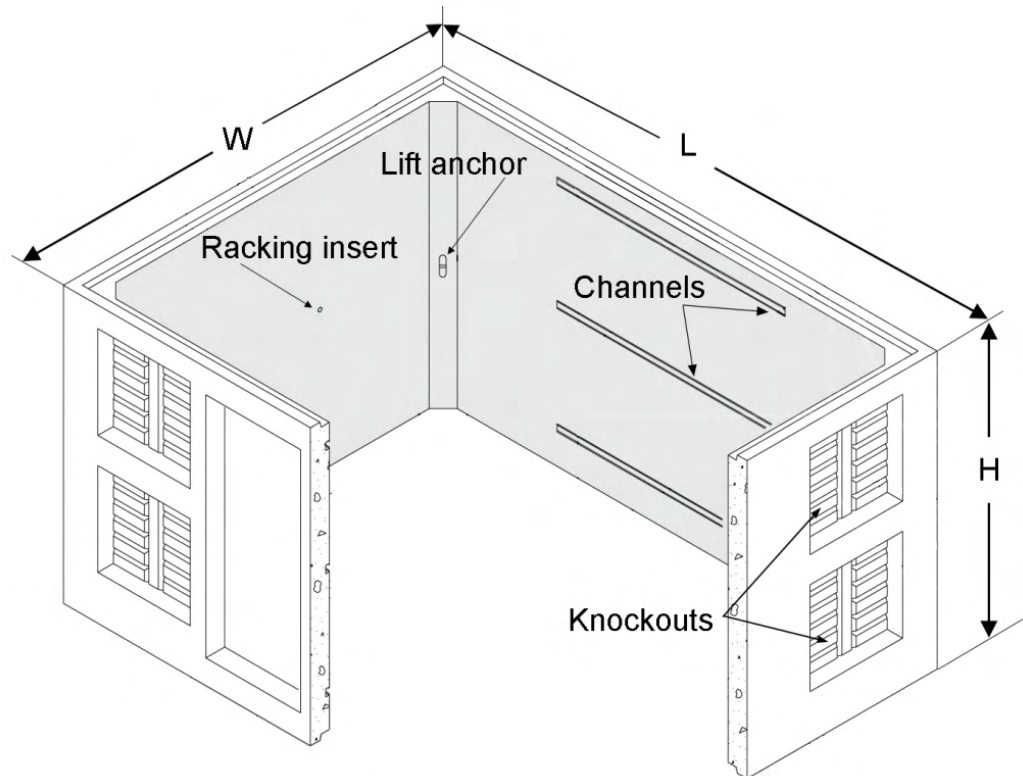
## 5. Mid-Section Requirements

The vault mid-section shall be constructed according to the dimensions and details shown in Table 5 and Figure 5.

**Table 5. Mid-Section Dimensions (Nominal)**

Stock No.	Outside			Inside		
	Length	Width	Height	Length	Width	Height
013735	8' 8"	6' 8"	4' 10"	8' 0"	6' 0"	4' 9"

**Figure 5. Mid-Section**



### 5.1 Knockouts, Waffle

Knockouts shall be of the waffle type.

Knockouts shall measure 18 in by 18 in.

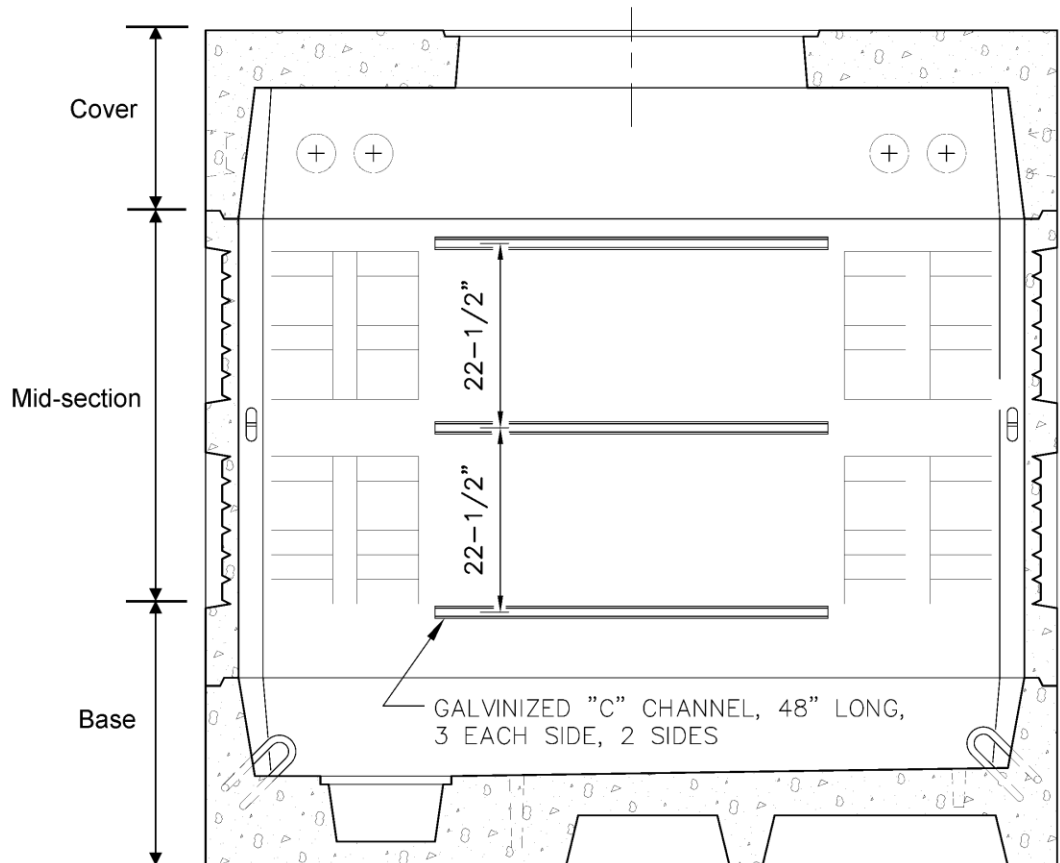
Four knockouts shall be located on the outer edge of each wall for a total of 16 knockouts.

## 5.2 Channels

Galvanized "C" channels shall be embedded and centered in the side walls between knockouts. There shall be 22-1/2 inches of space between channel rows as measured from the center of each row.

Channels shall measure 1-5/8 in by 13/16 in by 48 in. See Figure 5.2

**Figure 5.2. Channel Placement, Side Wall**

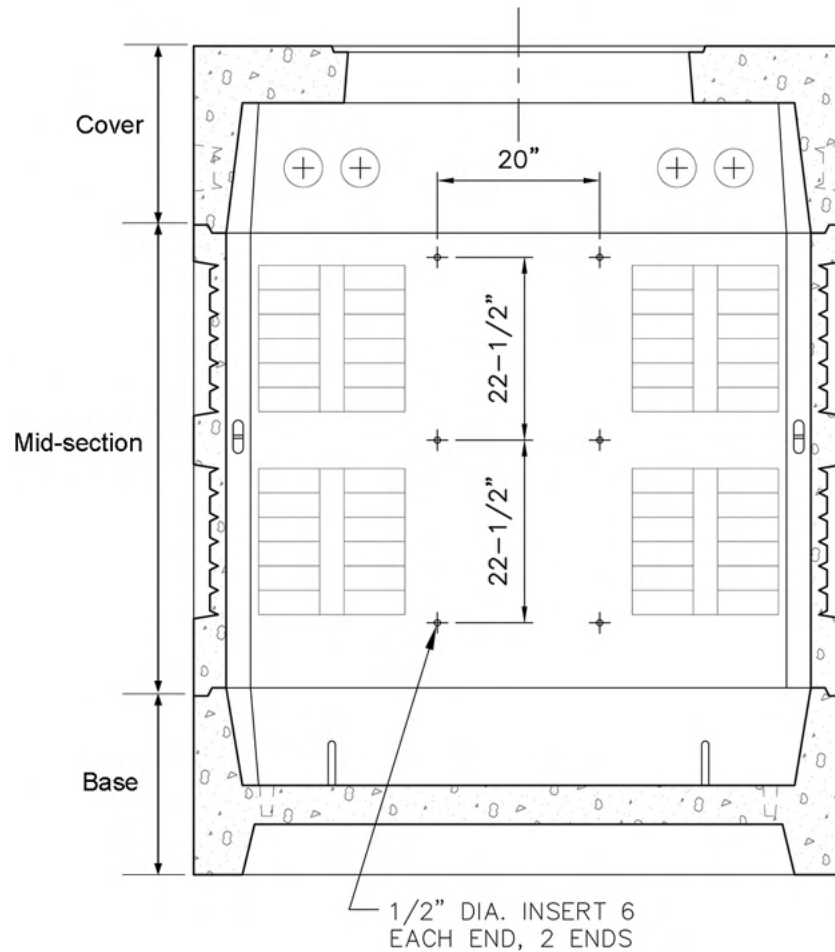


### 5.3 Racking Inserts

Racking inserts shall accommodate 1/2-in diameter threaded bolts.

Racking inserts shall be embedded in the center of end walls between knockouts. There shall be 20 inches of space (horizontal) and 22-1/2 inches of space (vertical) between racking inserts as measured from the center of each insert.

**Figure 5.3. Racking Insert Placement, End Wall**



### 5.4 Lift Anchor

A lift anchor with a 2-ton ultimate strength rating shall be located on each corner of the wall.

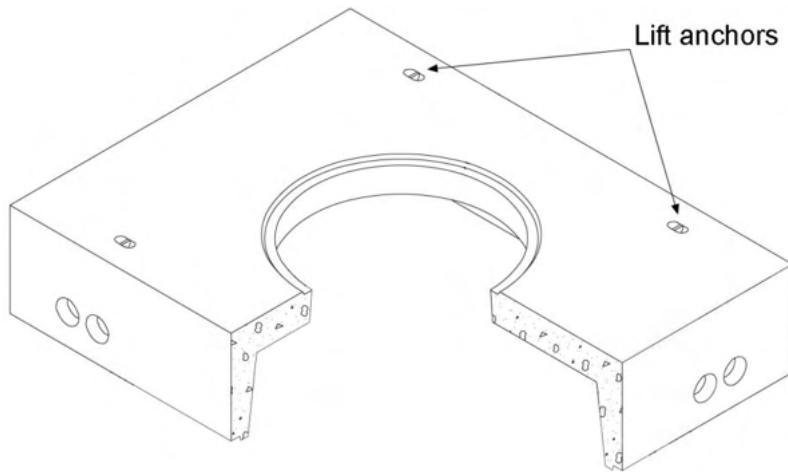
## 6. Cover Requirements

Covers shall be constructed according to the dimensions shown in Table 6 and Figure 6.

**Table 6. Cover Dimensions (Nominal)**

Stock No.	Outside			Inside			Access Configuration
	Length	Width	Height	Length	Width	Height	
013736	8' 8"	6' 8"	1' 10"	8' 0"	6' 0"	1' 3"	One 42" round

**Figure 6. Cover with Round Access**



The cover shall have:

- 2-ton lift anchors, two on each end of the top.
- A keyway on the cover to ensure a tight fit with the mid-section.

## 7. Issuance

Unit: EA

## 8. Approved Manufacturer

Stock No.	Components	Oldcastle/Utility Vault Catalog No.
013734	Base, standard 687	687-BL
013735	Mid-section with cable supports	687-ML
013736	Cover, with round access	687-TL-42C
013737	Assembly (base and cover with round access)	687-LA

## 9. References

- SCL Material Standard 7203.21**; "Precast Reinforced Concrete Structure, General"  
**SCL Material Standard 7204.70**; "Frames and Covers, 42-Inch Round, Iron"

## 10. Sources

**Ng, Sharon**; SCL Civil Engineer and subject matter expert for 7203.66  
(sharon.ng@seattle.gov)

**Wang, Quan**; SCL Standards Engineer, and originator and subject matter expert for  
7203.66 (quan.wang@seattle.gov)

## Precast Reinforced Concrete Transformer Pads



### 1. Scope

This standard covers the detailed requirements for precast reinforced concrete transformer pads.

This standard applies to the following Seattle City Light (SCL) stock numbers:

Stock No	Description
013721	Single phase transformer pad
013722	Three phase transformer pad (75–300 kVA)
013723	Three phase transformer pad (500–1500 kVA)
013724	Three phase transformer pad (2000–2500 kVA)

### 2. Application

Precast reinforced concrete transformer pads are used as a platform for transformers or switchgear.

If a precast or cast-in-place oil containment system is installed separately from the transformer pad, see SCL 0724.50 for installation details.

Due to their size, transformer pads will not be stocked in SCL inventory. Engineers and the Civil Crew Chief are required to order and specify delivery of these items.

### 3. General Requirements

This standard is to be used in conjunction with the latest revision of SCL 7203.21.

Standards Coordinator  
Quan Wang

Standards Supervisor  
John Shipek

Unit Director  
Andrew Strong

**4. Requirements, General**

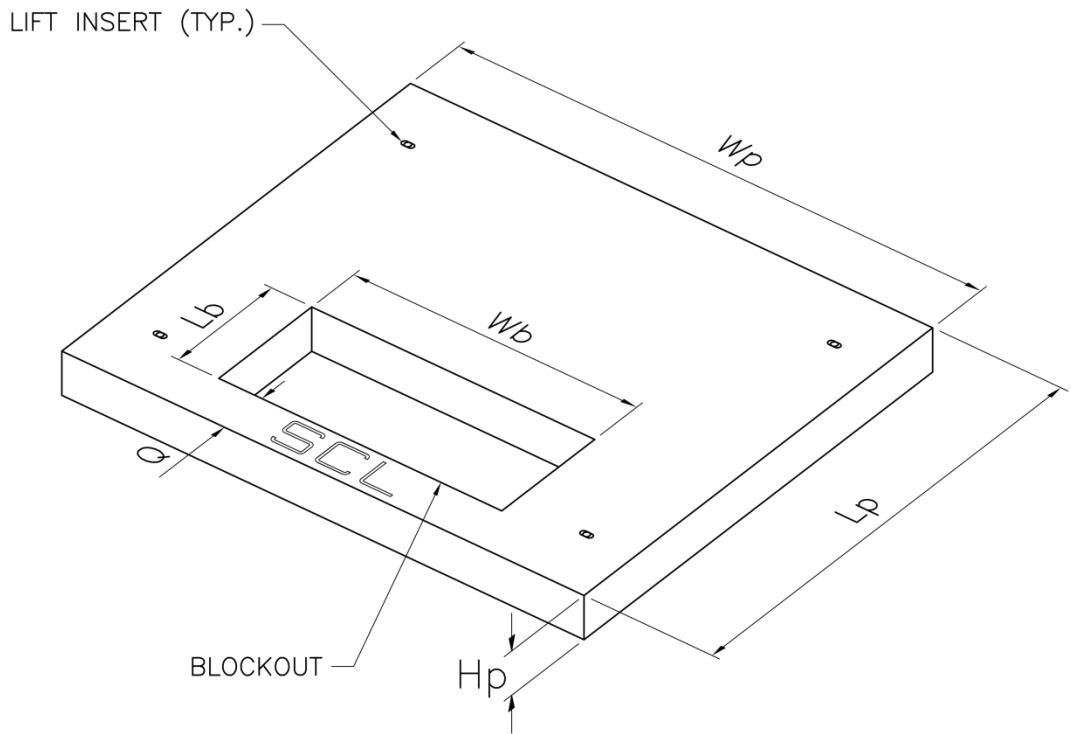
Pad grounding shall comply with SCL 7203.21.

Transformer pads shall be constructed according to the dimensions and details shown in Table 4.2 and figures 4.2a and 4.2b.

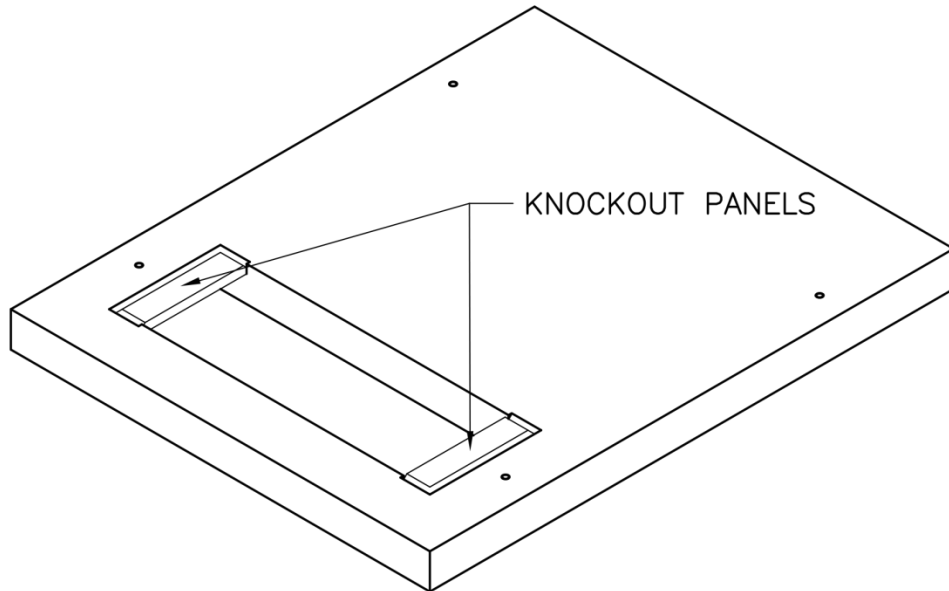
**Table 4.2. Pad Dimensions**

Stock No.	Dimensions, nominal (ft-in)			Blockout Dimensions, nominal (in)		Blockout placement from edge of pad (in)
	Width	Length	Height	Width	Length	
	$W_p$	$L_p$	$H_p$	$W_b$	$L_b$	$Q$
013721	4-0	4-8	0-6	22	14	8
013722	7-0	7-0	0-6	60	16	12
013723	8-0	7-9	0-6	60	16	12
013724	8-0	10-0	0-8	60	24	12

**Figure 4.2a. Transformer Pad**



**Figure 4.2b. Knockout Panel Detail**



Lift inserts measuring 3/4-inch in diameter (nominal) shall be located at each corner on the top side of the pad.

Caps shall cover each lift insert.

For all transformer pads except for Stock No. 013274, the letters “SCL,” measuring 3-in high, shall be cast into the top side of the pad.

For Stock No. 013724, knockout panels measuring 6 in x 24 in shall be installed on each side of the blockout.

---

**5. Issuance**

Unit: EA

---

**6. Approved Manufacturer**

Stock No.	Description	Catalog No.
		Oldcastle/Utility Vault
013721	Single phase transformer pad	54-1422
013722	Three phase transformer pad (75–300 kVA)	77-1660
013723	Three phase transformer pad (500–1500 kVA)	88-1660
013724	Three phase transformer pad (2000–2500 kVA)	77-810-2460

---

**7. References**

**SCL Construction Standard 0724.50**; “Customer Requirements for Padmount Transformer Services, Looped Radial System”

**SCL Material Standard 7203.21**; “Precast Reinforced Concrete Structure, General”



## 8. Sources

**Ng, Sharon**; SCL Civil Engineer and subject matter expert for 7203.76  
(sharon.ng@seattle.gov)

**Wang, Quan**; SCL Standards Engineer, originator, and subject matter expert for 7203.76  
(quan.wang@seattle.gov)

## Pull Tape, Polyester



### 1. Scope

This standard covers the requirements for polyester pull tape, also known as mule tape.

This standard applies to the following Seattle City Light (SCL) stock numbers:

Stock No	Length per Reel (ft)
012293	400, minimum
012480	3000

### 2. Application

Pull tape is used to initiate cable pulling in underground conduit systems.

### 3. Industry Standards

Pull tape shall meet the applicable requirements of the latest revision of the following industry standard:

**GR-356-CORE**; Generic Requirements for Optical Cable Innerduct, Associated Conduit, and Accessories

### 4. Requirements

Pull tape shall have the following attributes:

- Polyester
- Woven construction
- Silicone lubricated
- Printed with sequential footage markings
- Splice free

Standards Coordinator  
Muneer Shetab

Standards Supervisor  
John Shipek

Unit Director  
Andrew Strong

*Muneer Shetab* *John Shipek*

*Andrew Strong*

**Table 4. Polyester Pull Tape Requirements**

Stock No.	Tensile Strength (lb)	Approximate Width (in)	Length Per Reel (ft)
012293	2500	3/4	400 or 500
012480	2500	3/4	3000

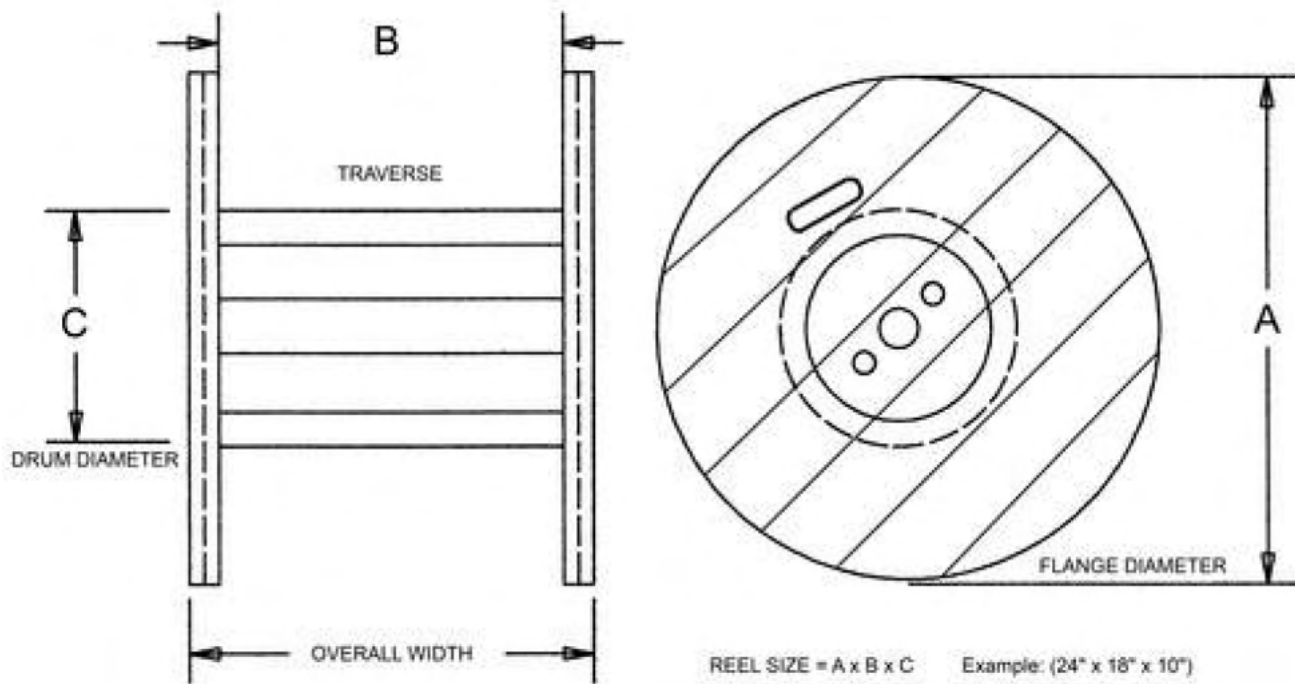
**5. Packaging**

Pull tape shall be packaged to prevent damage during shipping, handling, and storage. Reels shall be made of non-returnable plastic and have the dimensions shown in Table 5.

**Table 5. Reel Dimensions (in), Nominal**

Stock No.	Flange Dia. (A)	Traverse (B)	Drum Dia. (C)
012293	12	6	3-1/2
012480	13	10-1/2	3-1/2

**Figure 5. Reel Dimensions**



Each standard package shall be legibly marked with the following information:

- Manufacturer's identification
- Product description
- SCL stock number
- Quantity

Each shipping container shall be legibly marked with the following information:

- SCL purchase order number

**6. Issuance**

Stock Unit: FT

---

**7. Approved Manufacturers**

<b>Stock No.</b>	<b>Length Per Reel (ft)</b>	<b>Fibertek</b>	<b>Pacific Strapping Inc. (Herculine)</b>	<b>Neptco</b>
012293	400, minimum	WP2500-400	P2500W-400	WP2500P-500
012480	3000	WP2500-3000	P2500W-3000	WP2500P-3000

---

**8. Sources**

[www.fibertekinc.com](http://www.fibertekinc.com)

[www.neptco.com](http://www.neptco.com)

[www.pacstrap.com](http://www.pacstrap.com)

**Shetab, Muneer**; SCL Standards Engineer, originator, and subject matter expert for 7645.30 (muneer.shetab@seattle.gov)

**Stock Catalog Page 73-78**, June 11, 2018

## Mandrels, Proofing



### 1. Scope

This standard covers the requirements for rigid proofing mandrels. This standard applies to the following Seattle City Light (SCL) stock numbers.

Stock No.	Conduit Trade Size (in)
013294	3/4
013295	1
013296	1-1/4
013297	1-1/2
013298	2
013299	2-1/2
013300	3
013301	3-1/2
013302	4
013303	5
013304	6

### 2. Application

Rigid proofing mandrels are used to test for obstructions in an underground conduit run after trench backfill and/or conduit pour is complete.

The mandrel size should be at least as large as the largest cable pulling head (or grip) that could be used within that conduit to ensure cable can be pulled in successfully.

Standards Coordinator  
Brett Hanson

Standards Supervisor  
John Shipek

Unit Director  
Andrew Strong

### 3. Construction

Proofing mandrels corresponding to conduit sizes up to and including 3-1/2 inches shall be constructed per Figure 3a. A stainless steel, 1/8-in aircraft cable shall be run through the center of the mandrel, looped at the ends, and secured with red Loctite compound and a flat washer that does not exceed 80 percent of the diameter of the mandrel.

Proofing mandrels corresponding to conduit sizes 4 inches and larger will be constructed per Figure 3b. At each end of the mandrel, 1/2-in galvanized steel oval eye nuts shall be installed and secured with red Loctite compound to the 1/2-in galvanized rod via a lock washer and flat washer.

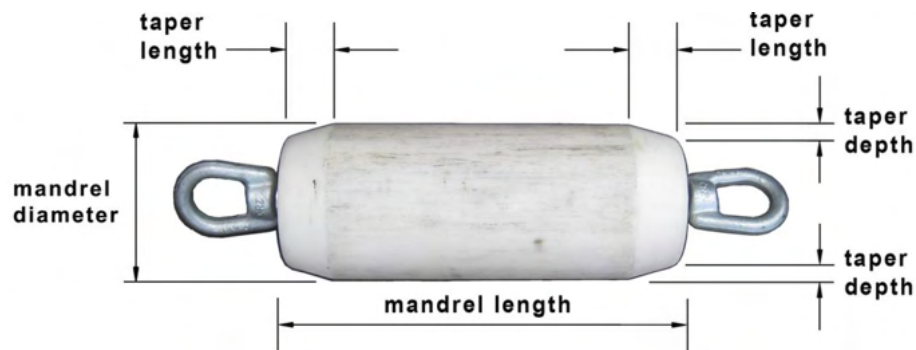
Acceptable dimensional mandrel length and diameter tolerance is +0% to -3%. See Table 3.

Each mandrel shall be marked in a permanent legible fashion with the stock number and date of manufacture. Marking shall appear on the mandrel end face to prevent damage.

**Figure 3a. Mandrel with Stainless Steel Cable**



**Figure 3b. Mandrel Construction**



**Table 3. Mandrel Dimensions**

Stock No.	Conduit Trade Size (in)	Mandrel Diameter (in)	Mandrel Length (in)	Taper Length (in)	Taper Depth (in)	Material	Figure
013294	3/4	0.62	1.0	–	–	Delrin or nylon	3.1
013295	1	0.78	1.25	–	–	Delrin or nylon	3.1
013296	1-1/4	1.00	1.5	–	–	Delrin or nylon	3.1
013297	1-1/2	1.25	1.75	–	–	Delrin or nylon	3.1
013298	2	1.62	2.25	–	–	Delrin or nylon	3.1
013299	2-1/2	2.00	2.75	–	–	Delrin or nylon	3.1
013300	3	2.50	3.25	–	–	Delrin or nylon	3.1
013301	3-1/2	3.00	3.75	–	–	Delrin or nylon	3.1
013302	4	3.50	8.0	1.0	0.5	Delrin or nylon	3.2
013303	5	4.75	12.0	1.5	0.5	Delrin or nylon	3.2
013304	6	5.50	14.0	2.0	0.7	Delrin or nylon	3.2

#### 4. Pre-Production Approval

The successful bidder shall submit a first prototype to SCL Standards for approval prior to the fabrication of the first production piece. The successful bidder shall submit a first production piece to SCL Standards for approval prior to the fabrication of the balance of the order.

---

#### 5. Issuance

Stock Unit: EA

---

#### 6. Approved Manufacturers

Bids may be solicited from any fabricator identified by Civil/Mechanical Engineering or Material Control as being capable.

---

#### 7. References

**SCL Construction Standard U2-11 / NDK-40**; “Mandreling and Cleaning of Ducts and Conduits”

**Hanson, Brett**; SCL Standards Engineer, and subject matter expert and originator of 7645.40 (brett.hanson@seattle.gov)

**Jerochim, Pete**; SCL Electrical Inspector and subject matter expert of 7645.40 (pete.jerochim@seattle.gov)

**Youngs, Rob**; SCL Electrical Inspector and subject matter expert of 7645.40 (rob.youngs@seattle.gov)

## Customer Requirements for Vault Signage

### TRANSPORTATION AGREEMENT

AN EQUIPMENT TRANSPORTATION AGREEMENT EXISTS FOR THIS VAULT. IF TRANSFORMER(S) OR RELATED EQUIPMENT NEEDS TO BE MOVED INTO OR OUT OF BUILDING, THE BUILDING OWNER IS RESPONSIBLE FOR MOVING IT.

#### 1. Scope

This standard covers the requirements for vault signage.

Selection of appropriate sign types, and sign text necessary for site-specific conditions, are outside the scope of this standard.

#### 2. Application

Specific signage is required to communicate vault conditions, such as when an Equipment Transportation Agreement (ETA) exists between a customer and Seattle City Light (SCL) for transformers or related equipment installed in a vault.

ETA signage is not provided by SCL. The customer is responsible for procuring signage per this standard and the specific sign text communicated in the SCL Service Letter.

Section 4 shows the Equipment Transportation Agreement sign. Section 5 shows examples of other signs that have been used in the past. These signs should be considered examples only.

Standards Coordinator  
Brett Hanson



Standards Supervisor  
John Shipek



Unit Director  
Andrew Strong





### 3. Requirements

Signage shall be as described below:

Material	Phenolic resin sheet
Dimensions	8-in x 8-in minimum. Increase size to maintain 1-inch border and 1-inch space between lines of text
Color	
Sign	Red
Lettering	White
Lettering style and size	
Style	All caps, sans serif font, engraved
Size	Title text: 1-in high, nominal Body text: 1/2-in high, nominal
Thickness (in)	1.6 mm, nominal
Mounting	4 holes, 5/16-in diameter, ± 1/16-in, on corners

---

### 4. Equipment Transportation Agreement Sign

Figure 4. Equipment Transportation Agreement Sign



### 5. Sign Examples

Figure 5a. Danger High Voltage Sign Example



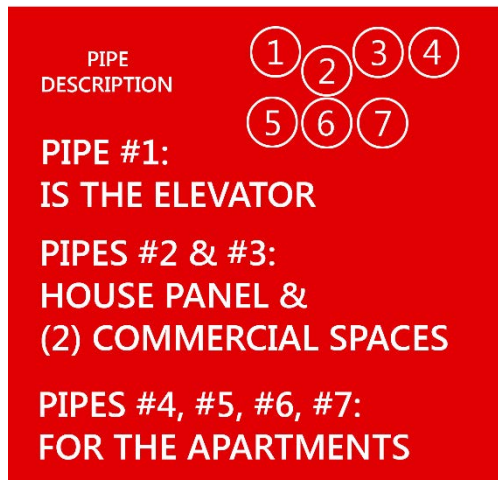
**Figure 5b. Heat Probe Sign Example**



**Figure 5c. Service Entrance Sign Example**



**Figure 5d. Service Entrance Sign for Cable in Conduit Example**



**Figure 5e. PT Deck Sign Example**



---

## 6. Approved Manufacturers

Designer Decal  
Electromark

## 7. Sources

**Customer Electric Service Installation Process (CESIP) Section 12.30**; "Equipment Transportation Agreement Procedure," SCL Energy Delivery Operations, June 2008

**Tilley, Kathy**; SCL Electrical Engineering Support Specialist, originator of 7651.25  
(kathy.tilley@seattle.gov)



